

# SECULIFE ES TECH

## High-End TRMS RF Surgical Generator Analyzer

3-447-146-03

1/8.22



## Table of Contents

<b>1</b>	<b>Safety Instructions</b>	<b>1</b>
<b>2</b>	<b>Applications</b>	<b>2</b>
2.1	Intended Use / Use for Intended Purpose	2
2.2	Use for Other than Intended Purpose	2
2.3	Liability and Guarantee	2
2.4	Opening the Instrument / Repairs	2
<b>3</b>	<b>Documentation</b>	<b>3</b>
3.1	Identifiers	3
3.2	Definition of Terms	3
<b>4</b>	<b>Getting Started</b>	<b>4</b>
<b>5</b>	<b>The Instrument</b>	<b>4</b>
5.1	Scope of Delivery	4
5.2	Optional Accessories	4
5.3	Instrument Overview	5
5.3.1	Front and Top	5
5.3.2	Left Side and Bottom	5
5.3.3	Right Side and Back	6
5.3.4	Symbols on the Instrument and the Included Accessories	6
5.4	Relevant Standards	7
5.5	Technical Data	8
5.6	Measurement and Testing Characteristics	9
5.6.1	Analyzer Modes	9
5.6.2	Digital Fast Acquisition Technology™ (DFA) Information	9
5.6.3	Calculated Ranges	9
5.6.4	RF Measurement/Testing	10
5.7	Load Bank Specifications	10
<b>6</b>	<b>Operation</b>	<b>11</b>
6.1	Powering the Device / Turning the Device On and Off	11
6.2	Operating the Device	11
6.2.1	Entering Text, Numbers and Symbols	12
6.3	Data Storage / File Management and Transfer	13
6.3.1	Saving a File	13
6.3.2	Opening a File	14
6.3.3	Transferring Files	15
6.4	External Devices	16
6.4.1	Using a Keyboard and Mouse	16
6.4.2	Using a Barcode Scanner	16
6.4.3	Using a USB Flash Drive	16
6.5	Connecting the Device to Your Network (LAN and Internet)	16
<b>7</b>	<b>Device Settings</b>	<b>17</b>
7.1	Setting System Date and Time	17
7.2	Calibrating the Touchscreen	17
7.3	Setting Display Averaging	17
7.4	Setting the Volume	18
7.5	Choosing the Startup Screen	18
7.6	Adjusting the Network Settings	18
7.7	Using System Profiles	19
7.8	Displaying System Information and Calibration Due Date	19
7.9	Displaying the serial number	20

---

7.10	Updating the device .....	20
7.10.1	Updating via FTP .....	20
7.10.2	Update via USB flash drive.....	20
7.10.3	Restore previous versions .....	21
7.11	System Maintenance (do not use) .....	21
<b>8</b>	<b>Measurements / Testing.....</b>	<b>22</b>
8.1	Preparing Measurements / Tests: Typical Connections .....	22
8.1.1	Output Test .....	22
8.1.2	External Loads .....	23
8.1.3	Leakage Tests .....	24
8.1.4	CQM Cable Differences .....	25
8.1.5	Footswitch .....	25
8.2	Measuring RF Energy .....	26
8.3	Measuring RF Leakage .....	29
8.4	Power Load Curves .....	32
8.4.1	Configure and Run Power Load Curves .....	32
8.4.2	Run Previously Configured Load Curve .....	34
8.4.3	View Saved Power Load Curves .....	35
8.5	REM/ARM/CQM (Return Electrode Control Quality Monitor Test) .....	35
8.5.1	Manual Mode.....	35
8.5.2	Auto Mode.....	35
8.5.3	Examples.....	36
8.6	Autosequences.....	37
8.6.1	Creating an autosequence .....	37
8.6.2	Using an Existing Autosequence .....	41
8.6.3	Running an Autosequence.....	41
8.6.4	Viewing Autosequence Results .....	43
<b>9</b>	<b>Remote Operation .....</b>	<b>44</b>
9.1	Remote Mode.....	44
9.1.1	Setting Up Your PC for Remote Mode (CERHost utility) .....	44
9.1.2	Using the Remote Mode .....	44
9.2	Remote control with Communication Protocol and PC.....	44
9.2.1	Setting up the Physical Connection.....	45
9.2.2	Port Information .....	45
9.2.3	Command Syntax.....	45
<b>10</b>	<b>Transport and Storage .....</b>	<b>52</b>
10.1	Transporting the Device .....	52
10.2	Storing the Device.....	52
<b>11</b>	<b>Maintenance .....</b>	<b>52</b>
11.1	Cleaning .....	52
11.2	Calibration .....	52
<b>12</b>	<b>Troubleshooting.....</b>	<b>53</b>
12.1	System Faults and Display Messages .....	53
12.2	Frequently Asked Questions.....	54
<b>13</b>	<b>Contact, Support and Service.....</b>	<b>55</b>
<b>14</b>	<b>CE Declaration.....</b>	<b>55</b>
<b>15</b>	<b>Returns and Environmentally Sound Disposal.....</b>	<b>56</b>
<b>16</b>	<b>Appendix.....</b>	<b>56</b>

---

# 1 Safety Instructions

Observe this documentation, in particular all included safety information, in order to protect yourself and others from injury, and to prevent damage to the instrument.

## General

- Carefully and completely read and adhere to these operating instructions.  
The document can be found at <http://www.gossenmetrawatt.com>. Retain this document for future reference.
- Tests/measurements may only be performed by a qualified electrician, or under the supervision and direction of a qualified electrician. The user must be instructed by a qualified electrician concerning performance and evaluation of the tests/measurements.
- Observe and comply with all safety regulations which are applicable for your work environment.
- Wear suitable and appropriate personal protective equipment (PPE) whenever working with the instrument.

## Accessories

- Use only the specified accessories (included in delivery or listed as optional) with the instrument.
- Carefully and completely read and adhere to the product documentation of the optional accessories. Retain these documents for future reference.

## Operating Conditions

- The instrument may only be used as long as it's in good working order.  
Inspect the instrument before use. Pay particular attention to damage, broken insulation or kinked cables. Damaged components must be replaced immediately.
- Accessories and cables may only be used as long as they're fully intact.  
Inspect all cables and accessories before use. Pay particular attention to damage, broken insulation or kinked cables.
- If the instrument or an accessory doesn't function flawlessly, remove it from operation and secure it against inadvertent use.
- If the instrument or accessory is damaged during use, e.g. through falling, remove it from operation and secure it against inadvertent use.
- Do not use the instrument after long periods of storage under unfavorable conditions (e.g. humidity, dust or extreme temperature).
- Do not use the instrument after extraordinary stressing due to transport.
- The instrument must not be exposed to direct sunlight.
- Do not submerge the device or spill liquids on it. Do not use if either occurred (corrosion hazard).
- Only use the instrument and the accessories in compliance with the specified technical data and under the specified conditions (ambient conditions, IP protection class, measuring category, etc.).  
Acclimate to specified conditions for at least 30 minutes before operating the device.
- Do not block the ventilation slots during operation (danger of overheating).
- Do not use the instrument in potentially explosive atmospheres.

## Measurements / Testing

- The instrument and the included accessories may only be used for the tests/measurements described in the instrument's documentation.
- The device is intended for testing only. It must never be used in diagnostics, treatment or any other capacity where it would come in contact with a patient.
- Refer to DUT manual for test procedures and measurement limits.
- Plugging in all cables (test leads, power cables etc.) must not necessitate any undue force.
- Never touch conductive ends (e.g. of the test leads).
- Never touch exposed metal surfaces on test leads or other current-carrying parts while the DUT is activated.
- Fully unreel the cable before starting a test/measurement. Never perform a test/measurement with the cable rolled up.
- Ensure that the alligator clips make good contact.

## Measurement Data

- Always create a backup copy of your measurement data.

## 2 Applications

Please read this important information!

### 2.1 Intended Use / Use for Intended Purpose

The SECULIFE ES TECH is a high-accuracy True RMS RF measurement and testing system designed to be used for routine performance verification, safety evaluation, and calibration of electro-surgical generators.

It is compatible with Covidien / Valleylab ForceTriad™, FT10™ and Ligasure™ generators, and most legacy generators by other manufacturers.

The device offers a high degree of accuracy and provides an low reactance internal load bank with a range of 0 to 5500  $\Omega$  in 5  $\Omega$  increments.

The SECULIFE ES TECH is microprocessor based and utilizes a combination of hardware and software to provide accurate and reliable test results, including from waveforms such as "spray". The current transformer internal to the device senses the RF current flowing through the internal test load and produces a radiometric voltage which is digitized and analyzed by the microprocessor. The DFA Technology™ utilized in the device allows the system to aggressively digitize the complex RF waveforms produced by electro-surgical generators, analyze each individual digital data point, and provide highly accurate measurement and testing results.

Safety of the operator, as well as that of the device, is only assured when it's used for its intended purpose.

### 2.2 Use for Other than Intended Purpose

Using the instrument for any purposes other than those described in the condensed operating instructions or these instrument operating instructions is contrary to use for intended purpose.

### 2.3 Liability and Guarantee

Gossen Metrawatt GmbH assumes no liability for property damage, personal injury or consequential damage resulting from improper or incorrect use of the product, in particular due to failure to observe the product documentation. Furthermore, all guarantee claims are rendered null and void in such cases.

Nor does Gossen Metrawatt GmbH accept any liability for data loss.

### 2.4 Opening the Instrument / Repairs

The instrument may only be opened by authorized, trained personnel in order to ensure flawless, safe operation and to assure that the guarantee isn't rendered null and void. Even original replacement parts may only be installed by authorized, trained personnel.

Unauthorized modification of the instrument is prohibited.



If it can be ascertained that the instrument has been opened by unauthorized personnel, no guarantee claims can be honored by the manufacturer with regard to personal safety, measuring and testing accuracy, compliance with applicable safety measures or any consequential damages.

If the guarantee seal is damaged or removed, all guarantee claims are rendered null and void.

## 3 Documentation

### 3.1 Identifiers

The following identifiers are used in this documentation:

Identifier	Meaning
 <b>Attention!</b> Warning	Safety information that must be complied with
 <b>Note!</b> Important	Important information which must be taken into consideration and complied with
✓ Prerequisite	A condition etc. which must be fulfilled before a given action can be taken
1. Procedural step	Steps of a procedure which must be completed in the specified order
↳ Result	Result of a procedural step
• Enumeration	Bullet lists
– Enumeration	
Fig. 1: Caption	Description of the content of a figure
Table 1:	Description of the content of a table
Footnote	Comment

### 3.2 Definition of Terms

The following terms are used in this document:

Device	SECULIFE ES TECH (analyzer for electro-surgical generators) tester / measurement device / analyzer
DUT	Device under test product undergoing testing / electro-surgical generator

## 4 Getting Started

1. Read and adhere to the product documentation. In particular observe all safety information in the documentation, on the tester and on the packaging.
  - ⇒ "Safety Instructions" 1
  - ⇒ "Applications" 2
  - ⇒ "Documentation" 3
2. Familiarize yourself with the device.
  - ⇒ "The Instrument" 4
  - ⇒ "Operation" 11
3. Setup the device ⇒ "Device Settings" 17.
4. Familiarize yourself with testing basics and then conduct the tests: ⇒ "Measurements / Testing" 22.
5. Store and/or transfer your test results ⇒ "Data Storage / File Management and Transfer" 13.

Other chapters that might interest you: ⇒ "Remote Operation" 44, ⇒ "Maintenance" 52, and ⇒ "Transport and Storage" 52.

## 5 The Instrument

### 5.1 Scope of Delivery

Please check for completeness.

- |   |  |
|---|--|
| 1 | SECULIFE ES TECH (M695F)   |
| 1 | Operating instructions   |
| 1 | Universal power supply   |
| 1 | Power adapter with international plugs   |
| 1 | Test lead kit (bipolar lead, active lead, earth/ground lead, jumper leads, ground lug, banana jack alligator clips, dispersive leads, RECQM lead (pin), CQM lead (no pin)) |
| 1 | Test report  |
| 1 | Calibration certificate  |

### 5.2 Optional Accessories

Some tests/measurements necessitate optional accessories:

- FT10 calibration cable kit (20-00141)
- Communications cable, USB null modem (20-41360)
- BNC to BNC cable (20-00232)
- Footswitch cable, unterminated (Z699A)
- Footswitch cable for Covidien ForceFx (Z699B)
- Footswitch cable for CONMED System 5000 (Z699C)
- Footswitch cable for Covidien ForceTriad (Z699D)
- Footswitch Simulator for Covidien ForceFx and ForceTriad, triggers cut, COAG, bipolar (20-03004)
- Footswitch cable for Olympus ESG-100 (20-03006)
- Footswitch cable for Olympus ESG-400 (20-03007)
- Footswitch simulator (20-03004)
- Footswitch port adapter (20-03050)



### 5.3 Instrument Overview

#### 5.3.1 Front and Top

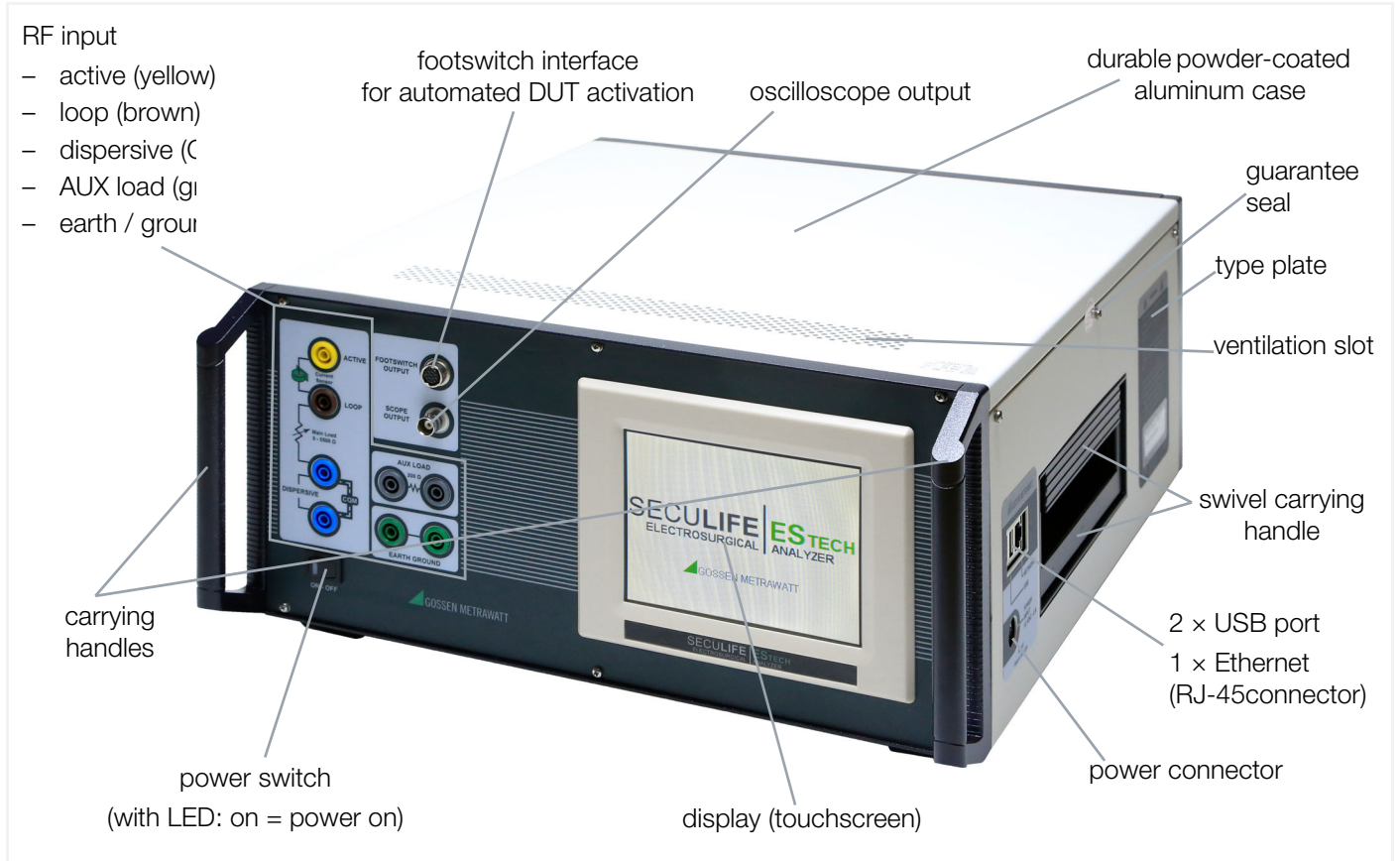

Fig. 2: Front and top panel

#### 5.3.2 Left Side and Bottom

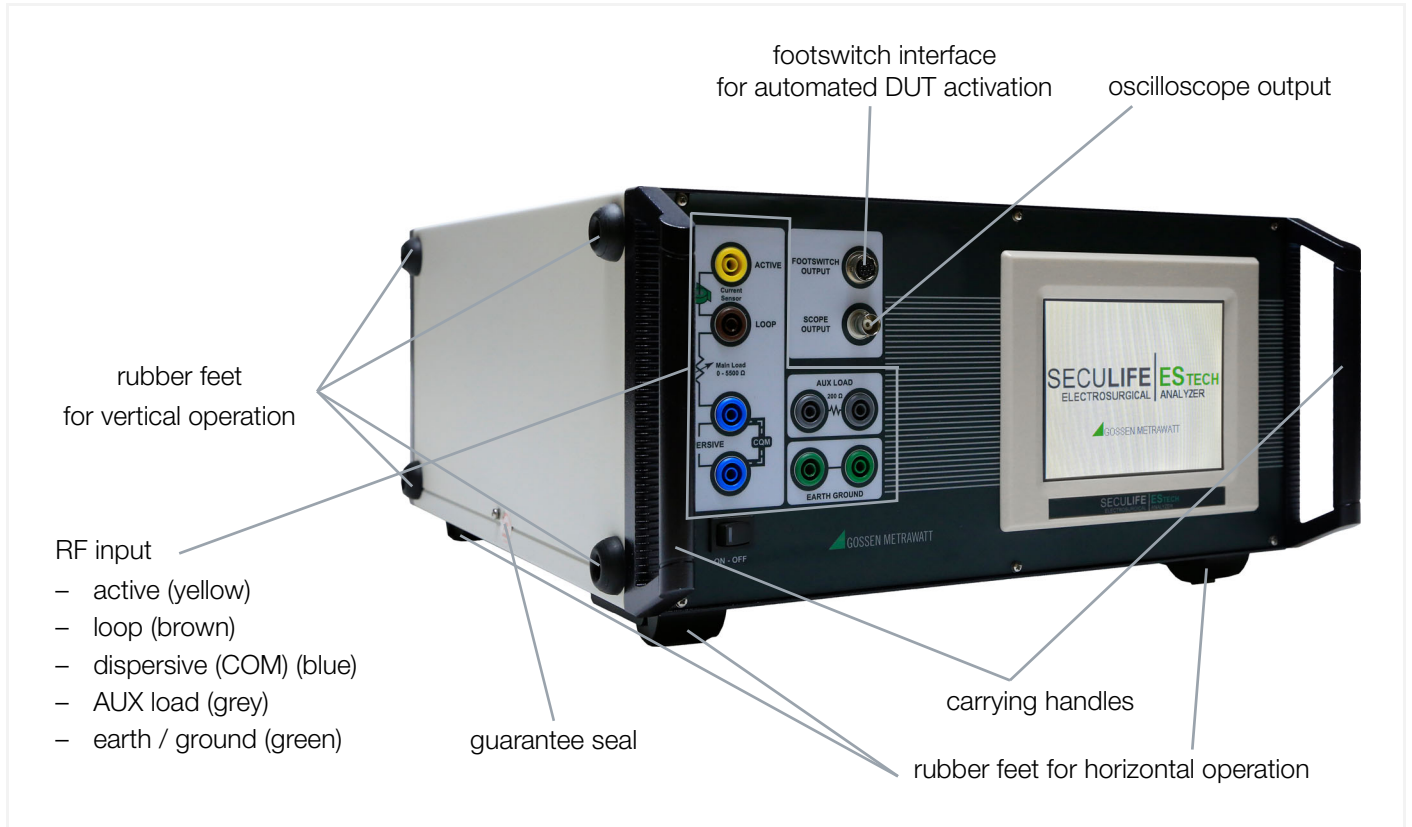

Fig. 3: Left and bottom of instrument



### 5.3.3 Right Side and Back

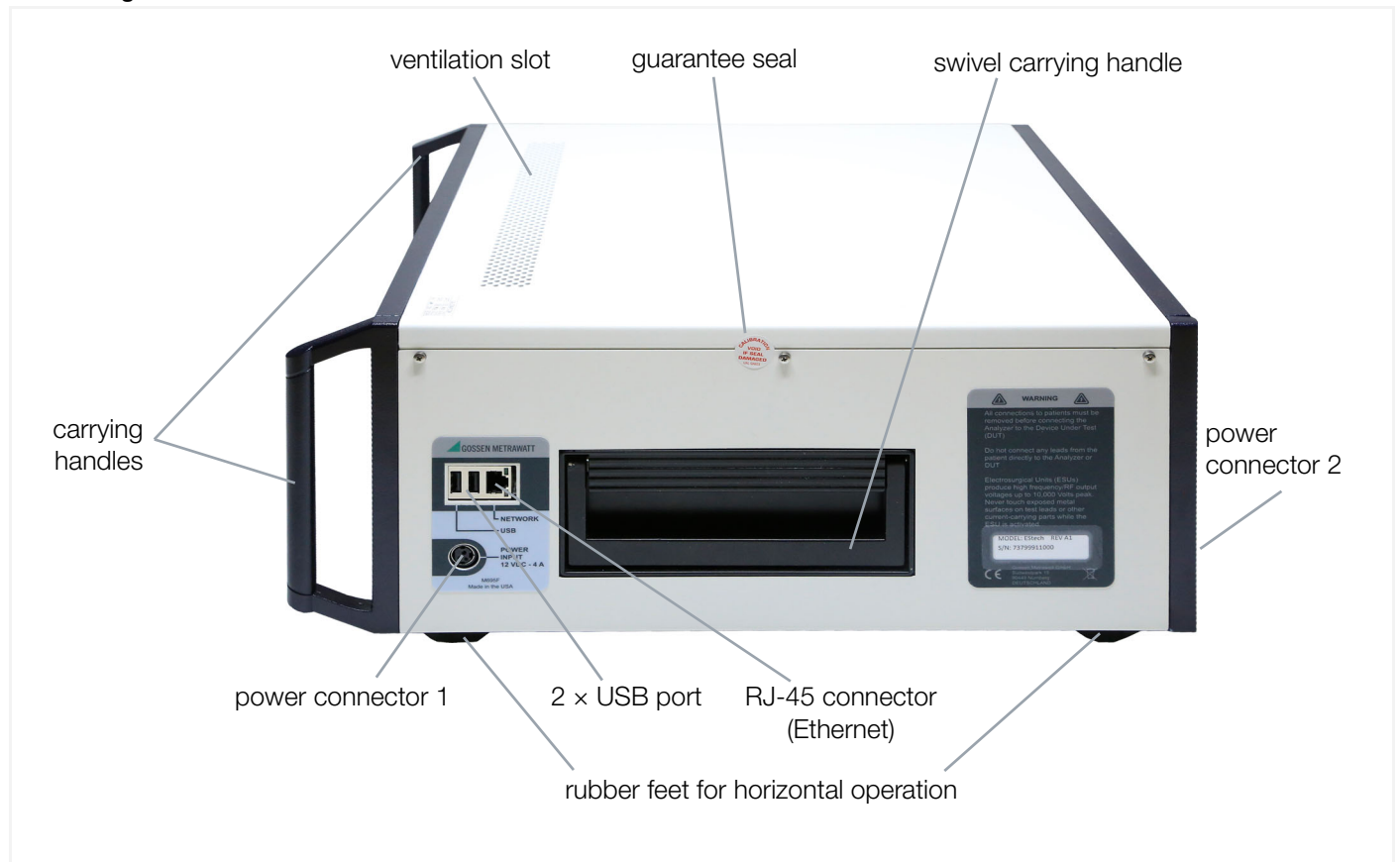

Fig. 4: Right of instrument

### 5.3.4 Symbols on the Instrument and the Included Accessories



Warning concerning a point of danger (attention, observe documentation!)



European conformity marking



The tester may not be disposed of with household trash ⇒ "Returns and Environmentally Sound Disposal" 56.

## 5.4 Relevant Standards

The tester has been manufactured and tested in accordance with the following safety regulations:

DIRECTIVE 2014/30/EU OF THE EUROPEAN PARLIAMENT AND OF THE COUNCIL of 26 February 2014 on the harmonisation of the laws of the Member States relating to electromagnetic compatibility (recast)	
DIRECTIVE 2014/35/EU OF THE EUROPEAN PARLIAMENT AND OF THE COUNCIL of 26 February 2014 on the harmonisation of the laws of the Member States relating to the making available on the market of electrical equipment designed for use within certain voltage limits (recast)	
COMMISSION DELEGATED DIRECTIVE (EU) 2015/863 of 31 March 2015 amending Annex II to Directive 2011/65/EU of the European Parliament and of the Council as regards the list of restricted substances	
REGULATION (EC) No 1907/2006 OF THE EUROPEAN PARLIAMENT AND OF THE COUNCIL of 18 December 2006 concerning the Registration, Evaluation, Authorisation and Restriction of Chemicals (REACH), establishing a European Chemicals Agency, amending Directive 1999/45/EC and repealing Council Regulation (EEC) No 793/93 and Commission Regulation (EC) No 1488/94 as well as Council Directive 76/769/EEC and Commission Directives 91/155/EEC, 93/67/EEC, 93/105/EC and 2000/21/EC	
EN 50581	Technical documentation for the assessment of electrical and electronic products with respect to the restriction of hazardous substances
EN 60529	Test instruments and test procedures Degrees of protection provided by enclosures (IP code)
EN 61010-1	Safety requirements for electrical equipment for measurement, control and laboratory use – Part 1: General requirements
EN 61000-3-2	Electromagnetic compatibility (EMC) – Part 3-2: Limits - Limits for harmonic current emissions (equipment input current ≤ 16 A per phase)
EN 61000-3-3	Electromagnetic compatibility (EMC) – Part 3-3: Limits - Limitation of voltage changes, voltage fluctuations and flicker in public low-voltage supply systems, for equipment with rated current ≤ 16 A per phase and not subject to conditional connection
EN 61326-1	Electrical equipment for measurement, control and laboratory use – EMC requirements – Part 1: General requirements

## 5.5 Technical Data

<b>Power Supply</b>	12 V <sub>DC</sub> , minimum 4 A, universal power supply unit; 2 power connectors, Kycon 3 position locking receptacle	
<b>Ambient Conditions</b>	Operating temperature:	+15 ... +30 °C
	Storage temperature:	-20 ... +60 °C
	Relative atmospheric humidity:	20 ... 80%, no condensation allowed
	Elevation:	max. 2000 m
	Place of use:	Indoor use only
<b>Measurements/ Testing</b>	Technology:	True RMS using DFA Technology™, industry standard current sensing
	Input connectors:	4 mm safety banana, color coded
	Output connectors:	oscilloscope, BNC (50 Ω), uncalibrated
	Foot switch:	3 relay controlled foot switch controls; connector: Hirose HR10A-10R-12S(71) mating connector: Hirose HR10A-10P-12P(74)
	Types:	V <sub>Peak</sub> , mA, crest factor, power (Watts), load voltage, programmable auto-sequences, programmable load curves, CQM testing with 1 Ω resolution, footswitch outputs for DUT triggering
	Reading accuracy:	± 2%
	A/D resolution:	14 bit/s
	A/D speed:	64 MSPS
	Calibration:	digital
<b>Electrical Safety</b>	Measuring category:	Cat II 1000 V
	Pollution degree:	2
<b>Electromagnetic Compatibility (EMC)</b>	Interference emission:	EN 61326- 1 class A
	Interference immunity:	EN 61326-1 EN 61326-2-1
<b>Mechanical Design</b>	Protection:	Housing: IP40 per EN 60529 (protection against ingress of solid foreign objects: ≥ 1.0 mm Ø; protection against ingress of water: not protected)
	Housing:	W × H × D: approx. 47 × 19,81 × 381 cm; enclosure: aluminum, face: LEXAN™
	Weight:	approx. 8.2 kg
	Display:	5.7" QVGA LCD, 320 × 240 px, color with white LED backlight; touchscreen
<b>Data Interfaces</b>	Touchscreen (resistive)	
	USB:	2 × USB port, type A connector to connect: keyboard, mouse, flash drive (FAT32 formatted)
	Ethernet:	1 × RJ-45 port; 10-Mbit/s, 100-Mbit/s for connection to a network for data storage, remote control, software updates
<b>Operating System</b>	Windows Embedded Compact 7	
<b>Internal Memory</b>	RAM:	512 DDR2
	Data storage:	32 GB
	Setup memory:	EEPROM, all parameters
	Memory retention:	10 years without power

## 5.6 Measurement and Testing Characteristics

### 5.6.1 Analyzer Modes

Measurement/Test	Description
RF energy	Allows use as a general-purpose RF meter, including current, voltage, power and timing measurement.
Leakage test, 1a	Tests the open circuit leakage of an isolated type CF generator. The test complies with IEC 601-2-2, section 201.8.7.3.101 a) 2), figure 201.106 for unloaded monopolar tests (active lead) and section 201.8.7.3.101 a) 3), figure 201.107 for unloaded bipolar tests (bipolar lead 1).
Leakage test, 1b	Tests the open circuit leakage of an isolated type CF generator. The test complies with IEC 601-2-2, section 201.8.7.3.101 a) 2), figure 201.106 for unloaded monopolar tests (dispersive lead) and section 201.8.7.3.101 a) 3), figure 201.107 for unloaded bipolar tests (bipolar lead 2).
Leakage test 2	Tests the leakage to ground of earth-referenced type BF generators. This test complies with IEC 601-2-2, section 201.8.7.3.101 a) 1) test 1, figure 201.104 for monopolar tests and section 201.8.7.3.101 a) 3), figure 201.107 for bipolar tests.
Leakage test 3	Tests the leakage to ground of earth-referenced type BF generators. This test complies with IEC 601-2-2, section 201.8.7.3.101 a) 1) test 2, figure 201.105 for monopolar tests.
Load curve	Allows to automatically generate a power curve based on varying load, commonly seen in the generator data sheets.
REM/ARM/CQM	Uses internal load bank as a variable resistor to test the DUT's CQM/RECQM circuit.
Autosequence mode	Allows you to follow a standard or custom defined protocol to sequentially buildup a test record, applicable to many DUT manufacturer's recommended verification and calibration procedures.

### 5.6.2 Digital Fast Acquisition Technology™ (DFA) Information

The Digital Fast Acquisition Technology™ (short DFA) is a revolutionary new method of measuring/testing the generator output power of electro-surgical generators.

A high-speed analog to digital converter is used to digitize the high frequency, high power output of the electro-surgical generator. An RF current transformer is used to convert the current signal to a voltage signal, which is read by the analog to digital converter. By digitizing the signal a more accurate, frequency independent measurements/testing is made possible.

US Patent No. 9,883,903.

### 5.6.3 Calculated Ranges

<b>Load voltage</b>	0 ... 1000 V <sub>RMS</sub>	
	Resolution:	1 V
	Accuracy:	± 5%
<b>Power</b>	0 ... 999.9 W	
	Resolution:	0.1 W
	Accuracy:	± (4% of reading + 1W)
<b>Crest factor</b>	1.4 – 500	
	Resolution:	0.1

## 5.6.4 RF Measurement/Testing

### Characteristics

<b>Input</b>	Impedance:	0 ... 5500 $\Omega$
	Connection:	4 mm safety jack
	Maximum voltage:	10 kV
	Frequency:	10 kHz ... 10 MHz
	Method:	Pearson current to voltage converter, 0.1 V : 1 A
<b>Voltage</b>	pk, pk – pk:	2.0 ... 1000.0 mV
	Resolution:	0.1 mV
<b>Current</b>	Range:	2 ... 7000 mA RMS
	Resolution:	1 mA RMS

### Accuracy

	$f \leq 2.5 \text{ MHz}$	$2.5 \text{ MHz} < f \leq 5 \text{ MHz}$	$f > 5 \text{ MHz}$
Input $\leq 50 \text{ mA}$	$\pm 2\%$ reading or $\pm 1 \text{ mA}$	$\pm 2$ reading or $\pm 1 \text{ mA}$	$\pm 2\%$ reading or $\pm 1 \text{ mA}$
$50 \text{ mV} < \text{Input} \leq 400.0 \text{ mA}$	$\pm 2\%$ reading	$\pm 4\%$ reading	$\pm 6\%$ reading
Input $> 400.0 \text{ mA}$	$\pm (2\% \text{ reading} + 0.25\% \text{ range})$	$\pm (4\% \text{ reading} + 0.25\% \text{ Range})$	$\pm (6\% \text{ reading} + 0.25\% \text{ range})$

## 5.7 Load Bank Specifications

<b>Maximum current</b>	0 $\Omega$	8 A RMS external load
	5 – 5500 $\Omega$	3.5 A RMS internal or internal + external load
<b>Internal load selection</b>	Range:	0 ... 5500 $\Omega$ , 5 $\Omega$ steps
	Resolution:	5 $\Omega$
	Accuracy:	1% $\pm 0.5 \Omega$ , non-inductive
	Power rating:	< 50 $\Omega$ : 400 W 50 to < 800 $\Omega$ : 500 W $\geq 800 \Omega$ : 300 W
	Duty cycle:	10 seconds on, 30 seconds off
	Load cooling:	Dual 120 mm variable speed fans (controlled by load temperature or input power measurement)
<b>External load selection</b>	Resolution:	0 ... 5500 $\Omega$
	Accuracy:	1 $\Omega$

## 6 Operation

### 6.1 Powering the Device / Turning the Device On and Off

Power supply and turning the device on

#### **Attention!**

The device has 2 power connectors. Use only 1 power connection at any time!

1. Connect the supplied power cord suitable to your country to the supplied power pack.
  2. Connect the other end of the power pack cable to 1 of the device's power connectors → 5.
  3. Connect the power cord to an outlet.
  4. Flip the power switch.  
The power switch LED will light up.
- ↳ The device is powered and will startup. The main screen will be display after boot-up.

#### Turning the Device Off

- ✓ You have completed working with the device (no running measurements/tests).
  - ✓ All data is saved (e.g. no file transfer is still running).
1. Flip the power switch.
- ↳ The power switch LED will turn off. The device is powered off.

#### **Note!**

If you want to transport the device, e.g. to use it at another location, follow the transport instructions → 52.

### 6.2 Operating the Device

The device boots to the main screen by default and show the operating modes as well as settings.

#### **Note!**

The power up screen can be changed → 18 to your preference.

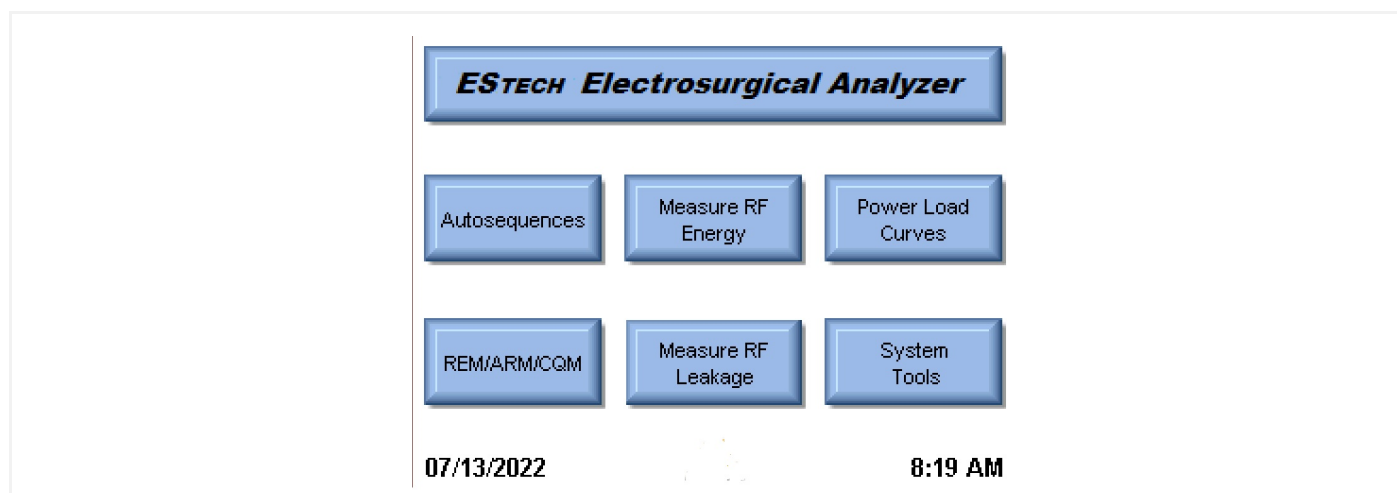

Fig. 5: Device main menu

The display is a touch screen and allows you to access the menus (blue) by tapping on them. To navigate, tap on the arrows (white). For settings and selections tap the button respectively scroll through the offered list items and tap to select. Settings and selections must be saved by tapping the corresponding button.

The menus and their functions are describes in the respective chapters:

- Autosequences → 37
- Measure RF Energy → 26
- Power Load Curves → 32
- REM/ARM/CQM → 35
- Measure RF Leakage → 29
- System Tools → "Device Settings" 17



### 6.2.1 Entering Text, Numbers and Symbols

When text or numbers need to be entered, a digital keyboard will be displayed. If only numbers have to be entered, a numpad will be displayed.

**Note!**

You can use an external keyboard and mouse to make it easier ⇒ "External Devices" 16.

#### Display Keyboard

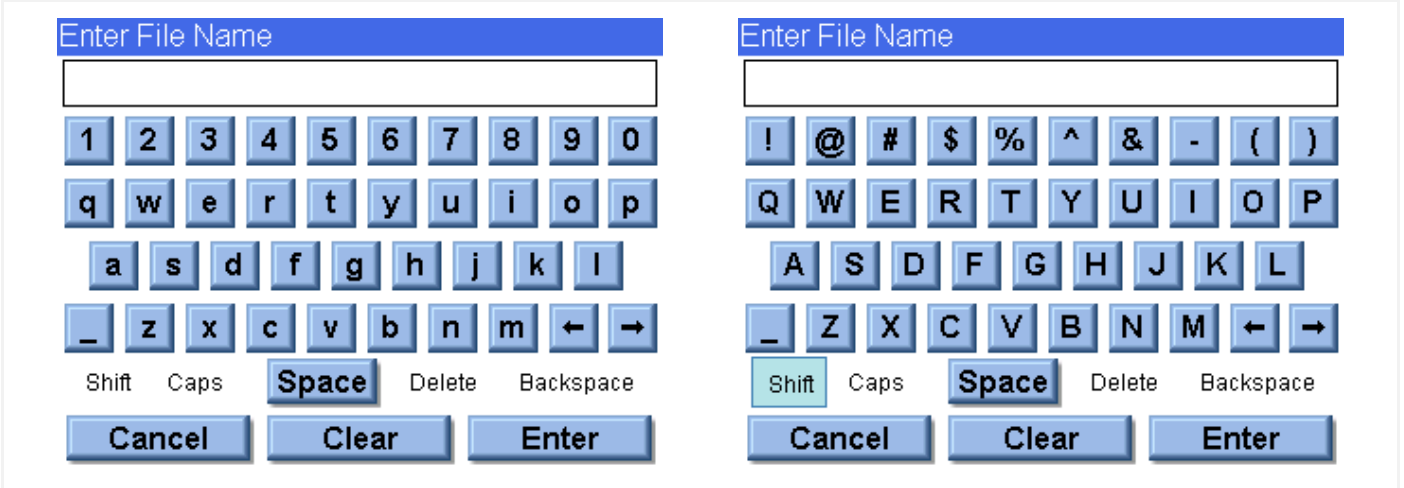

Fig. 6: Display keyboard

Tap the respective letter, symbol, number or space to enter it. Use the following buttons for specific functions:

- Arrows: Navigating within entered text
- Shift: Toggle between upper/lowercase characters and numbers/symbols. To switch back, tap again.
- Caps: Toggle between upper/lowercase characters and numbers/symbols. To switch back, tap again.
- Delete: Deletes the letter/number/symbol/space after the cursor.
- Backspace: Deletes the letter/number/symbol/space before the cursor.
- Cancel: Exits the screen without submitting any values.
- Clear: Clears the current entry box.
- Enter: Saves the entry and exits the keyboard.

#### Numpad

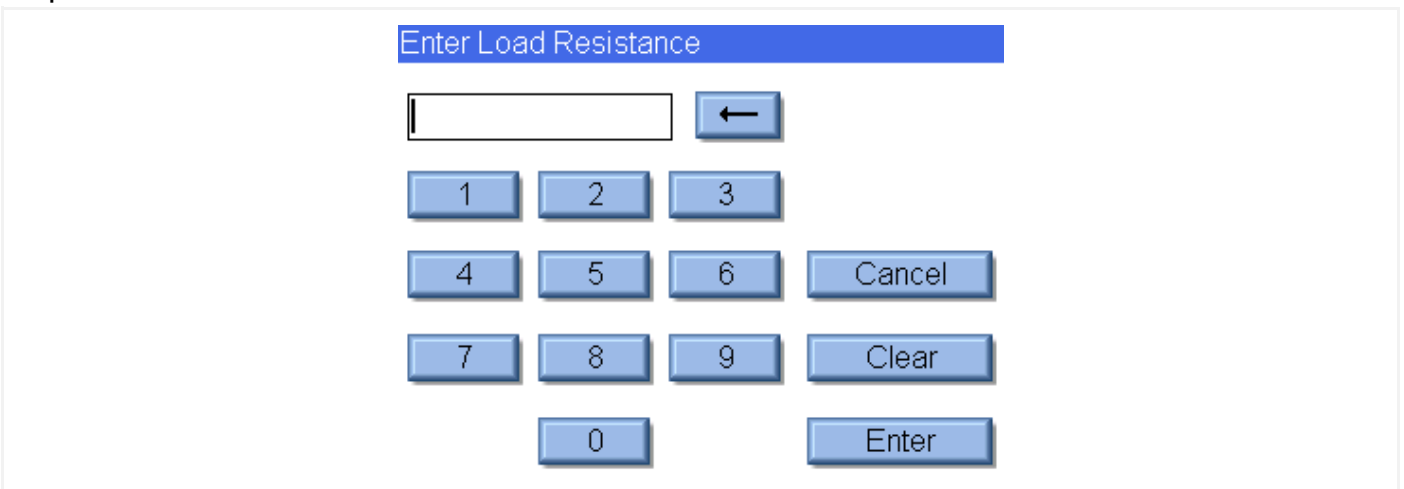

Fig. 7: Display numpad

Tap the respective number. In addition you can use the following buttons for specific functions:

- Back arrow: Deletes the last number.
- Cancel: Exits the screen without submitting any values.
- Clear: Clears the current entry box.
- Enter: Saves the entry and exits the keyboard.

### 6.3 Data Storage / File Management and Transfer

The device has internal memory and you can connect an external memory in form of a USB flash drive (⇒ "External Devices" 16). You can also connect the device to your network (⇒ 16) and store files on network drives.

In either you can store a file or open one from it. This storing and opening of files is used for different purposes in the device, e.g.

- backing up your device configuration, i.e. the system profile(s) (\*pfl) ⇒ 19.
- saving configured load curves for repetitive use (\*ldc) ⇒ 32
- saving load curve results and viewing them later (\*crv) ⇒ 32
- saving and later re-using configured autosequences (\*.ase or \*.sse) ⇒ 37
- saving autosequence results as test file (\*tst) to view them later or as PDF (\*pdf) to add them to the DUT's documentation ⇒ 37

You will be offered to save or open a file whenever it is possible.

You can also transfer the files stored in the internal memory either to a different internal location or to the USB flash drive for backup and further use.

#### 6.3.1 Saving a File

To save any given file, browse to the desired folder (double tap to open a folder), then tap **Name** and the keyboard will appear. Enter the desired file name and tap **OK**. See below for detailed options like drive selection.

Exit any time by tapping **Cancel**.

To save files externally, a USB flash drive must be connected (⇒ 16) or the device needs to be connected to your network (⇒ 16).

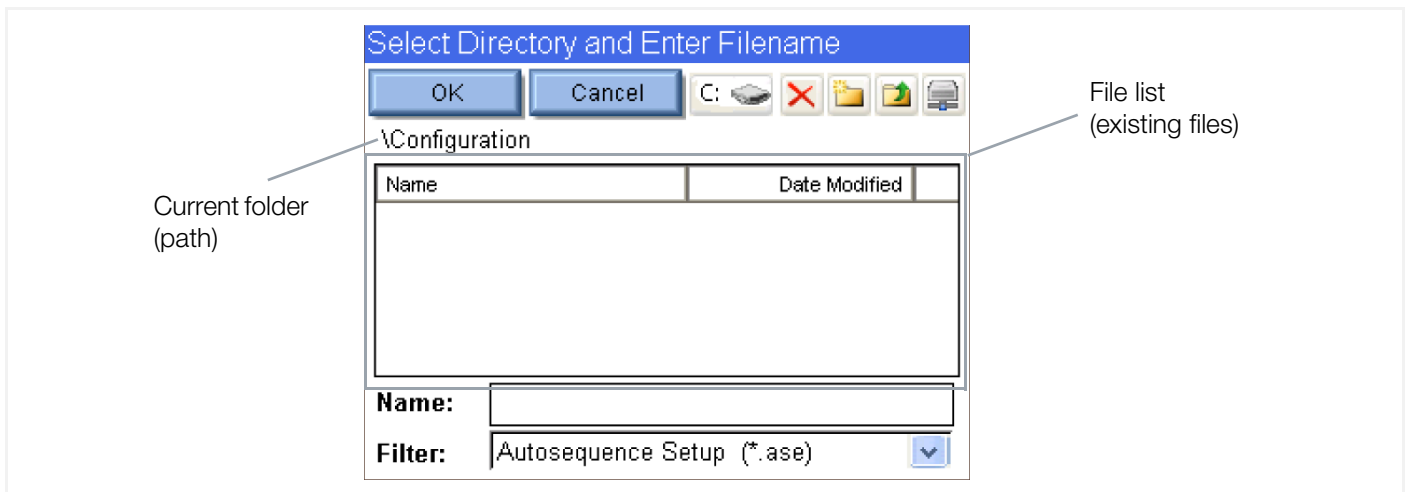







Fig. 8: Storing a file dialog

- OK: Saves selected file.
- Cancel: Exit dialog without saving a file.
- Drive selection: Target drive selection, either local drive (C:) oder USB drive (D: or E:).
- 
- Delete: Deletes the selected file or folder.
- 
- New folder: Creates a new folder in the current directory.
- 
- Folder up: Move up one folder in the file structure.
- 
- Network access: Save a file to a shared network drive. A dialog will appear, prompting you to define the network path.
- 
- Name: Tap to enter the name for the file to be saved.
- Filter: Type of file to be saved. (Only visible if multiple file types are available.)

### 6.3.2 Opening a File

You can open previously saved files (↔ 13) from the internal storage, a connected USB flash drive (↔ 16) or a network drive if your device is connected to the network (↔ 16).

To open any given file, browse to it in the file list and then either double tap on it or tap on the file to select it once and then tap on the **OK** button.

Exit any time by tapping **Cancel**.

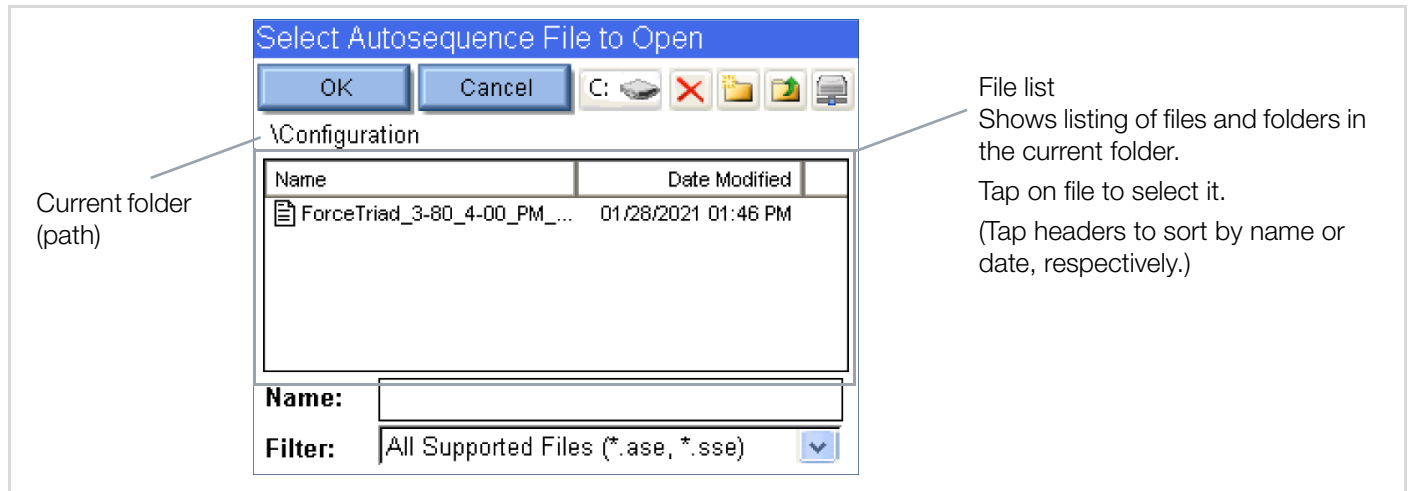

Fig. 9: Opening a file dialogue

**OK:** Opens the selected file.

**Cancel:** Exit dialog without opening a file.

**Drive selection:** Source selection, either local drive (C:) oder USB drive (D: or E:)



**Delete:** Deletes the selected file or folder.



**New folder:** Creates a new folder in the current directory.



**Folder up:** Move up one folder in the file structure.



**Network access:** Load a file from a shared network drive.  
A dialog will appear, prompting you to define the network path.



**Name:** Tap to enter the file by entering it's name.

**Filter:** Limit display of files to the type selected. (Only visible if multiple file types are available.)

### 6.3.3 Transferring Files

You can transfer previously saved files (→ 13) from the internal storage to another location within the internal storage or to a connected USB flash drive (→ 16). To open a folder, double tap on it. To select a folder or file, tap on it.

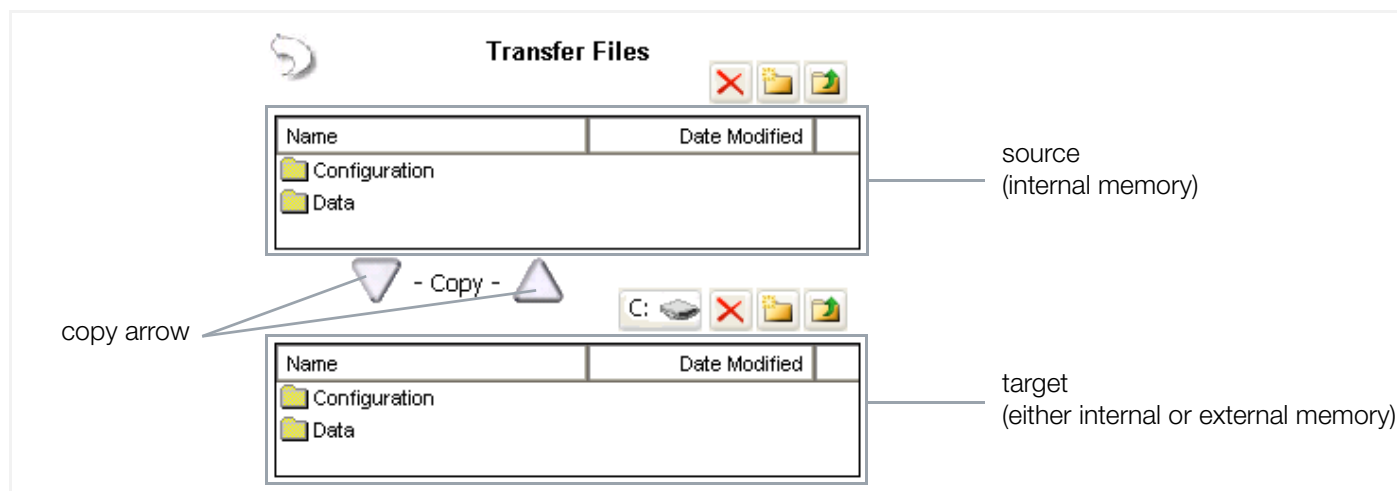

Fig. 10: File transfer

Drive selection:



Source selection, either local drive (C:) oder USB drive (D: or E:)

Copy:



Copies the selected file or folder to the drive the respective arrow is pointing to.

Delete:



Deletes the selected file or folder.

New folder:



Creates a new folder in the current directory.

Folder up:



Move up one folder in the file structure.

1. In the device main menu, tap **System Setup**.  
The **System Setup** menu appears.
2. Tap **Transfer files**.  
The **Transfer Files** dialog appears.
3. Select the target drive.
4. Tap on the file or folder to be copied, to select it.
5. Tap the arrow to copy.  
↳ The files are copied.

## 6.4 External Devices

You can use external input devices to facilitate data input: a USB keyboard, USB mouse, and USB barcode scanner can be connected.



### Attention!

In most cases, the external USB keyboard is optional. However, when designing autosequences (⇒ 137) it is required to create instruction steps.

You can also connect a USB flash drive.



### Note!

Most Windows supported USB keyboards, USB mice, and USB barcodes scanners, and USB flash drives are compatible.

### 6.4.1 Using a Keyboard and Mouse

The device is compatible with standard USB keyboards and mice. Connect your USB keyboard and mouse to the USB ports on the device to use them.

If a USB mouse is connected the cursor is automatically displayed on the screen. You can use it as usual to navigate and select.

If a USB keyboard is connected is automatically active any time numerical or text entry is required.



### Attention!

In most cases, the external USB keyboard is optional. However, when designing autosequences (⇒ 137) it is required to create instruction steps.

### 6.4.2 Using a Barcode Scanner

The device is compatible with USB barcode scanners. Connect your barcode scanner to a USB port on the device to use it.

They make entering DUT information easier: When the device prompts you to enter DUT information, trigger the barcode scanner (instead manually entering text). The text coded in the barcode will be entered then.

### 6.4.3 Using a USB Flash Drive

The device is compatible with USB flash drives that are FAT32 formatted. Connect your USB flash drive to a USB port on the device to use it.

You can

- store data on it ⇒ 13,
- transfer stored data to it ⇒ 15,
- install an update from it ⇒ 20.

## 6.5 Connecting the Device to Your Network (LAN and Internet)

You can connect the device to your network and to the Internet via its Ethernet port. This connection is required for the features network data storage (⇒ 13), and remote control (⇒ 44), as well as for updates via FTP (⇒ 20).

- ✓ You have set up a LAN that also allows a connection to the Internet.
- ✓ Your network is configured in such a way, that new devices can be added and gain access to the Internet.
- ✓ Your network has a DHCP server.

1. Connect the device is physically to the Internet through an RJ-45 Ethernet connection ⇒ 5.

↳ The device automatically receives an IP address, subnet mask, and gateway via DHCP.

To see the device's network information (assigned IP address, it's network name, etc.) and / or change to a static IP address see ⇒ "Adjusting the Network Settings" 18.

## 7 Device Settings

The tools screen is for the configuration of the device; it allows you to adjust system settings as well as update the firmware. There are two pages of system tools. Use the arrows at the bottom of the page to navigate through the system setup pages. The round indicators at the bottom of the screen identify which page is currently viewed:

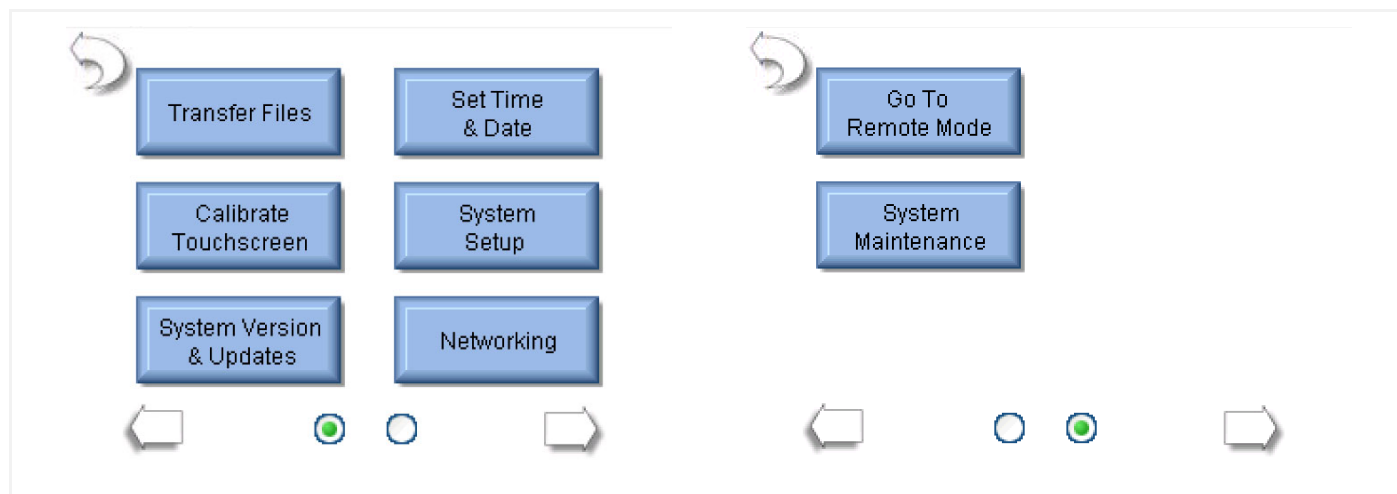

Fig. 11: System tools menu

**Note!** Remote mode and file transfer are described in → "Data Storage / File Management and Transfer" 13 and → "Remote Operation" 44, respectively.

### 7.1 Setting System Date and Time

- In the main menu, tap **System Tools**.  
The **System Tools** menu appears.
- Tap **Set Date & Time**.  
The **Date & Time** menu appears.
- Depending on what you want to change, tap the blue **Today's Date** or the blue **System Time** button.  
The date respectively time picker appears.
- Select the desired value in the picker.
- Tap the blue **Today's Date** or the blue **System Time** button.  
↳ The setting is saved.

### 7.2 Calibrating the Touchscreen

- In the main menu, tap **Calibrate Touchscreen**.  
The **Calibrate Touchscreen** menu appears.
- Follow the on-screen prompts to perform the 4-point calibration.  
↳ The touchscreen is calibrated.

### 7.3 Setting Display Averaging

The display averaging settings (Slow, Medium, and Fast) determine the number of samples used in averaging the RMS measurements/tests. The larger the number, the more stable the reading, but the less sensitive the system will be to small changes in readings. The filter span determines the maximum change in input readings that will be averaged.

For more information on the individual settings, tap the help icons.

- In the main menu, tap **System Setup**.  
The **System Setup** menu appears.
- In the **Display Averaging** area, tap the blue button of the setting you want to change.  
The picker appears.
- Tap the blue button again.  
↳ The setting is saved.



## 7.4 Setting the Volume

1. In the main menu, tap **System Setup**.  
The **System Setup** menu appears.
2. In the **System** area, tap the blue **up** or **down Volume** button (repeatedly) to the desired value.  
↳ The setting is saved.

## 7.5 Choosing the Startup Screen

Selects the screen that is loaded after the device is powered up: Main, RF measurement, load curves, autosequence, CQM.

1. In the main menu, tap **System Setup**.  
The **System Setup** menu appears.
2. In the **System** area, tap the **Startup Screen** selection list.  
The list entries appear.
3. Choose the desired startup screen.  
↳ The setting is saved.

## 7.6 Adjusting the Network Settings

As default, the device is set to receive it's IP address and other network settings via DHCP. You can change this to a static IP address.

You can also take a look at it's network settings – e.g. IP address, MAC address, or network name – to help with your network administration and change some of them.

### IP Address, Subnet Mask, and Default Gateway

✓ The device is physically to your network ⇌ 16.

1. In the main menu, tap **System Tools**.  
The **System Tools** menu appears.
2. Tap **Networking**.  
The **TCP/IP Configuration** menu appears. It displays the current status:

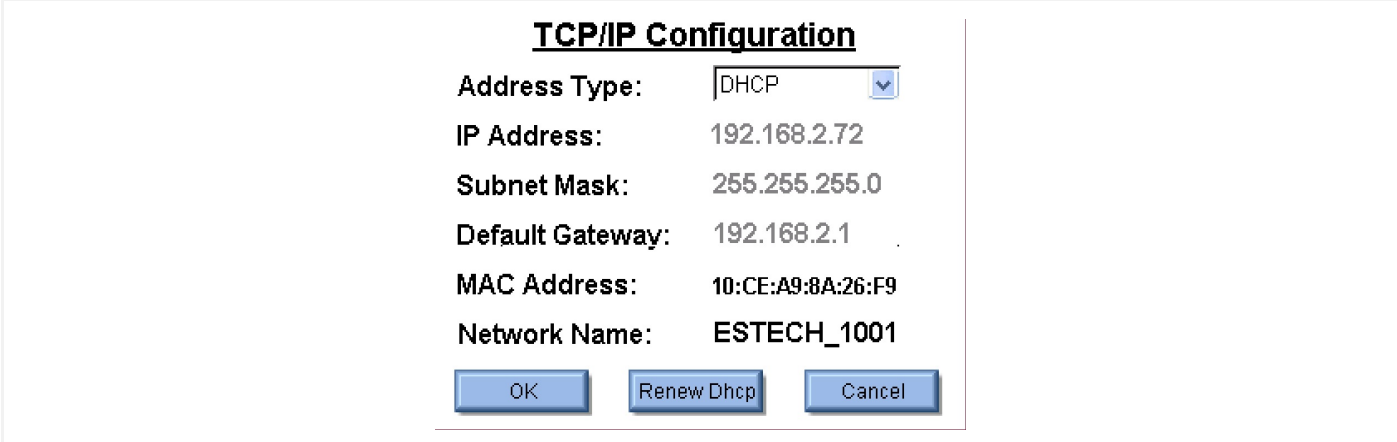

The screenshot shows a dialog box titled "TCP/IP Configuration" with the following settings:

TCP/IP Configuration	
Address Type:	DHCP
IP Address:	192.168.2.72
Subnet Mask:	255.255.255.0
Default Gateway:	192.168.2.1
MAC Address:	10:CE:A9:8A:26:F9
Network Name:	ESTECH_1001

At the bottom of the dialog, there are three buttons: "OK", "Renew Dhcp", and "Cancel".

Fig. 12: Network status

3. Select the IP address mode: **DHCP** (dynamic automatic assignment) oder **Static**.
4. If **Static** is selected, enter the
  - IP address
  - subnet mask
  - default gateway
 that you have reserved for the device. To do so, tap on the respective values displayed. The numpad will appear and you can enter the data.  
If **DHCP** is selected, the device will be assigned IP address, subnet mask, and default gateway automatically by your DHCP server.
5. Tap **OK**.  
↳ The setting is saved. The device will automatically reboot for the change to take effect.



### Note!

If **DHCP** is selected, you can renew the lease in the **TCP/IP Configuration** menu by tapping **Renew Dhcp**.

## Network Name

This is the name under which the device will announce itself in your network. The default is: ESTECH\_<serial number>. (For information on the serial number see ⇨ 19.)

You can change the network name.

✓ The device is physically to your network ⇨ 16.

1. In the main menu, tap **System Tools**.

The **System Tools menu** appears.

2. Tap **Networking**.

The **TCP/IP Configuration menu** appears. It displays the current status.

3. Select the IP address mode: **DHCP** (dynamic automatic assignment) oder **Static**.

4. Tap **Network Name**.

The digital keyboard will appear.

5. Enter the new name.

6. Tap **OK**.

↳ The setting is saved. The device will automatically reboot for the change to take effect.

## 7.7 Using System Profiles

Profiles are used to save the measurement/test configuration, averaging settings, volume, and the startup screen. The selected profile will be loaded on system startup.

You can save the current settings as a profile. If you save several profiles to use for different testing purposes, you can switch between them.

### Save New Profile

1. In the main menu, tap **System Setup**.

The **System Setup** menu appears. In the **System Profiles** area, the currently selected profile is displayed under **Current Profile**.

2. In the **System Profiles** area, tap the blue **Save Profile** button.

3. Follow the on-screen prompts.

↳ The profile is saved.

### Load Profile

1. In the main menu, tap **System Setup**.

The **System Setup** menu appears. In the **System Profiles** area, the currently selected profile is displayed under **Current Profile**.

2. In the **System Profiles** area, tap the blue **Load Profile** button.

3. Follow the on-screen prompts.

↳ The profile is loaded.

### Reset to Default Profile

1. In the main menu, tap **System Setup**.

The **System Setup** menu appears. In the **System Profiles** area, the currently selected profile is displayed under **Current Profile**.

2. In the **System Profiles** area, tap the blue **Default Profile** button.

↳ The default profile is set.

## 7.8 Displaying System Information and Calibration Due Date

You can call basic information about the system including software versions and calibration due date.

1. Tap on the title bar of the device main menu.

The device system information is displayed.

To exit the screen, tap anywhere on the screen.

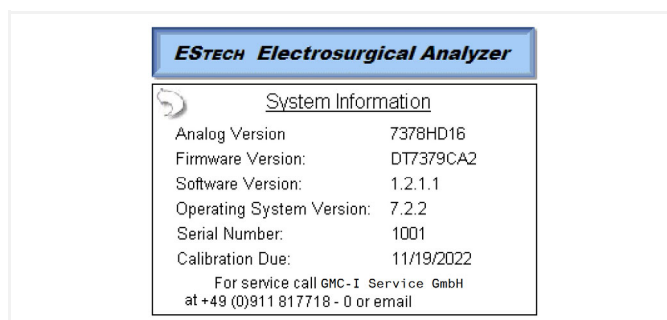

Fig. 13: System information



### Note!

For updating the device see ⇨ "Updating the device" 20

## 7.9 Displaying the serial number

1. In the main menu, tap **System Setup**.  
The **System Setup** menu appears.
- ↳ In the **System** area, the serial number is displayed under **Serial Number**.

## 7.10 Updating the device

You can update the device via FTP or USB flash drive.

The process for updating the system is to download the updated files, backup the existing software, install the new software.



### Note!

When updating the "Software" or "OS", the device will reboot automatically.

### 7.10.1 Updating via FTP

- ✓ The device is connected to the Internet ⇨ 16.

The updates files are made available on an FTP server. The device will query this server automatically.

1. In the main menu, tap **System Setup**.  
The **System Setup** menu appears.
2. Tap **System Version & Updates**.  
The **Current System Version** menu appears.
3. Tap **Update System**.  
The **Update System** menu appears. It indicates, the connection status.  
If an update is available, the **Update** button is displayed at the bottom.
4. Tap the **Update** button.  
The **Update System** menu appears. It shows all available updates.
5. Select the desired updates by activating the check boxes.
6. Tap **Update Selected**.
- ↳ The device automatically downloads and installs the selected updates.  
While doing so, it displays the progress.

### 7.10.2 Update via USB flash drive

When updating from a USB flash drive, you must individually update

- Analog: update files begin with filename "FP7379".
- Firmware: update files begin with filename "DT7379" and have an extension of ".S19".
- Software: update files begin with filename "ESTECH\_", end with the revision code and have an extension of ".exe".
- Operating system: update files begin with "NK\_" and have an extension of ".bin".

For update files, please contact us ⇨ "Contact, Support and Service" 55.

- ✓ You have the files for the update(s) you want to perform.
- ✓ You have copied the update files to the USB flash drive and connected it to the device ⇨ 5.

1. In the main menu, tap **System Setup**.  
The **System Setup** menu appears.
2. Tap **System Version & Updates**.  
The **Current System Version** menu appears.
3. Tap **Update System**.  
The **Update System menu** appears. It indicates, the connection status.  
If an update is available, the **Update** button is displayed at the bottom.
4. Tap the **From Flash Disk** tab.  
The **From Flash Disk** menu appears.
5. Tap the desired update button.
6. Follow the on-screen prompts.
- ↳ The device installs the selected updates.  
While doing so, it displays the progress.

### 7.10.3 Restore previous versions

Each time the device is updated, it creates a backup of the previous version in case it is ever needed. The firmware, software, and operating system files are restored independently.

1. In the main menu, tap **System Setup**.  
The **System Setup** menu appears.
2. Tap **System Version & Updates**.  
The **Current System Version** menu appears.
3. Tap **Restore Previous Version**.  
The **Restore System** menu appears.
4. Tap the tab of the desired version (**Firmware, Software, Operating System**).  
The previously installed versions are displayed.
5. Select the desired version in the list.
6. Tap **Restore**.  
↳ The device restores the selected version.

### 7.11 System Maintenance (do not use)

This menu is to be used by the manufacturer only to calibrate and debug the device.



#### **Attention!**

Do not use this feature.

---

## 8 Measurements / Testing

To prepare for testing you need to familiarize yourself with the typical measurement/test connections first → 22.

Then you can perform the following tests:

- RF energy → 26  
This mode provides for RF measurements. You can configure the device for the desired RF measurement including load setting, etc.
- RF leakage → 29  
This mode provides for RF Leakage measurements. You can configure the device for the desired RF leakage measurement including load setting.
- Power load curves → 32  
This mode provides for automated load curve testing of the DUT. Load curves can be configured for multiple load values and power levels.
- REM/ARM/CQM → 35  
This mode allows for testing the REM/ARM/CQM function of the DUT. The resistance can be manually entered, adjusted by a specific resistance, or adjusted by a percent of resistance. This mode also has the ability to set the CQM load to an open circuit.
- Autosequences → 37  
This mode provides for automated DUT testing. Autosequences can consist of any combination of User Instructions, RF measurements, Load Curves, or CQM tests. They can be edited, loaded, and saved to either in the internal memory or on an external USB flash drive.

### 8.1 Preparing Measurements / Tests: Typical Connections

The device utilizes an internal current transformer and internal precision load resistors for simple configuration of typical DUT testing. Many of the world's leading electro-surgical generator (DUT) manufacturers utilize this exact same technique when they test, service, and calibrate their products.

In this chapter, typical measurement/tests connections are explained.

#### ! Attention!

Testing may only be performed by qualified personnel. They must have specialized knowledge to know how to set up appropriate measurement/test connections and, if required, adapt them.

#### ! Attention!

Use the test leads included in delivery or available as optional accessories only.

#### 8.1.1 Output Test

##### Monopolar

1. Yellow active lead from active port on device to DUT output.
2. Blue CQM cable (no pin) from dispersive port on device to DUT dispersive.

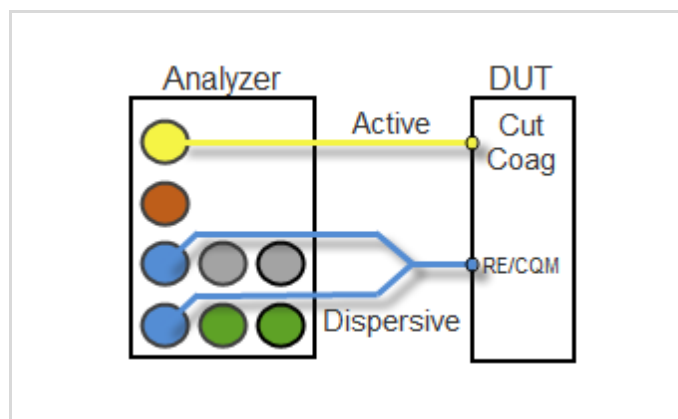

Fig. 14: Monopolar output test connections

**Bipolar**

1. Yellow active lead from active port on device to DUT bipolar output electrode number 1.
2. Blue Lead from Dispersive1 port on device to DUT bipolar output electrode number 2.

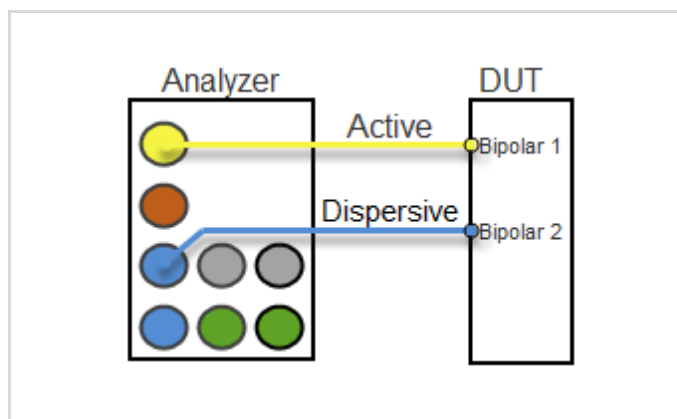

Fig. 15: Bipolar output test connections

**8.1.2 External Loads**

**Monopolar**

1. Yellow active lead from active port on device to DUT output.
2. Blue lead from loop port on device to external load.
3. Blue dispersive lead from external load to DUT dispersive.

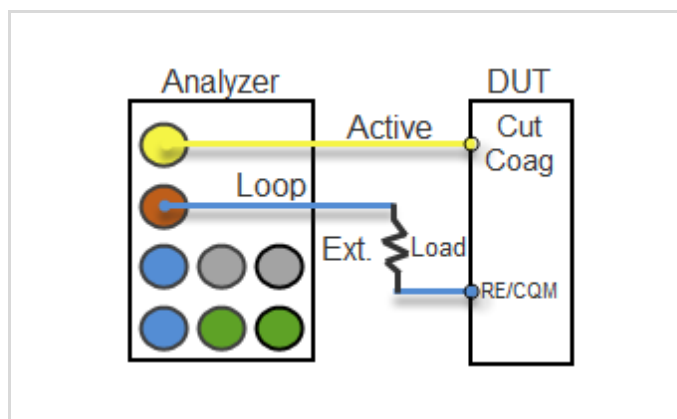

Fig. 16: Monopolar output test external load connections

**Bipolar**

1. Yellow active lead from active port on device to DUT bipolar output electrode number 1.
2. Blue lead from dispersive 1 port on device to external load.
3. Blue dispersive lead from external load to DUT bipolar output electrode number 2.

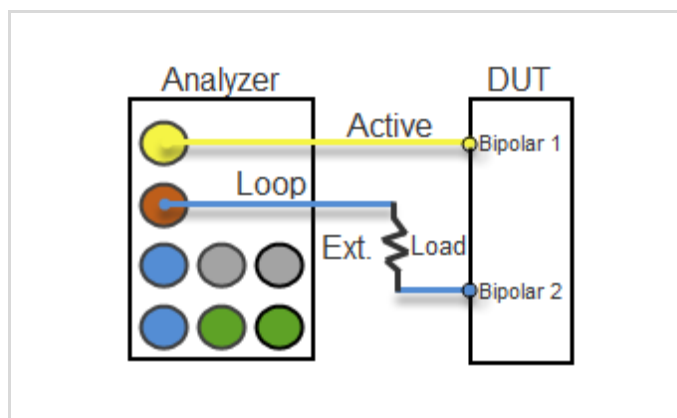

Fig. 17: Bipolar output test external load connections



**8.1.3 Leakage Tests**

**Leakage 1a**

1. Active port on device to DUT active output or bipolar 1.
2. Jumper lead from dispersive port to earth ground port on device.
3. Earth Ground port on the device to the ground lug on the back of the DUT using the green cable and green alligator clip.

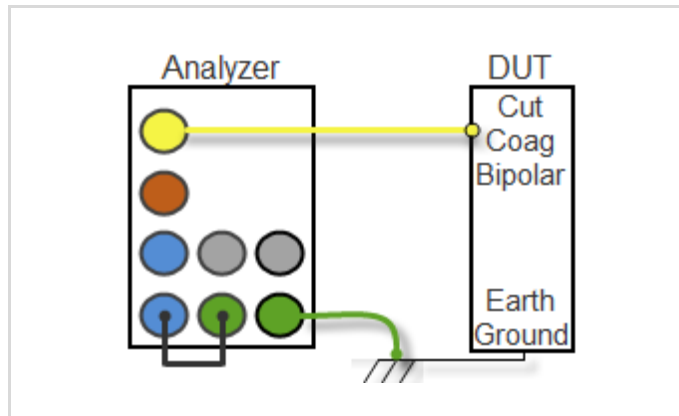

4. Leakage 1a connections

**Leakage 1b**

1. Dispersive 1 port on device to DUT dispersive output.
2. Jumper lead from dispersive port to earth ground port on device.
3. Earth ground port on the device to the ground lug on the back of the DUT using the green cable and green alligator clip.

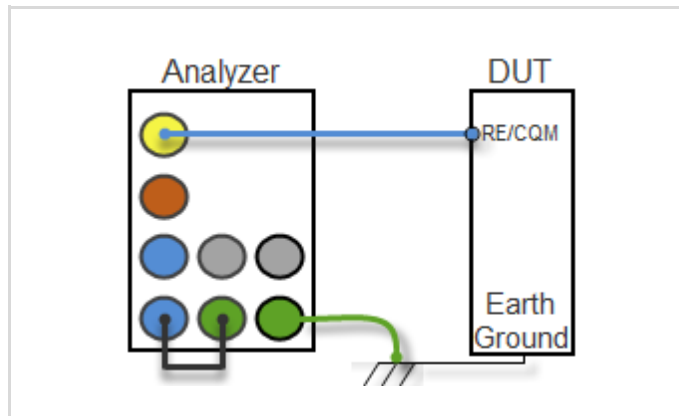

4. Leakage 1b connections

**Leakage 2**

1. Active lead from dispersive port on device to DUT active output.
2. Dispersive lead from loop port on device to DUT dispersive.
3. Jumper lead from active port on device to aux port on device.
4. Jumper lead from earth ground port on device to aux port on device.
5. Earth ground port on device to the ground lug on the back of the DUT using the green cable and green alligator clip.

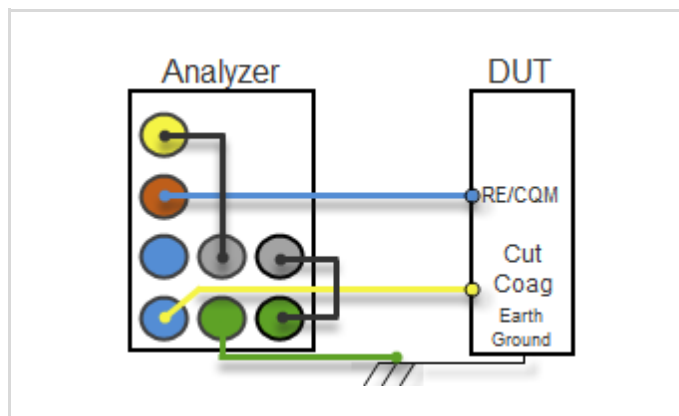

6. Leakage 2 connections

**Leakage 3**

1. Active lead from dispersive port on device to DUT active output.
2. Dispersive lead from aux port on device to DUT dispersive.
3. Jumper lead from active port on device to aux port on device.
4. Jumper lead from earth ground port on device to loop port on device.
5. Earth Ground port on device to ground lug on the back of the DUT using the green cable and green alligator clip.

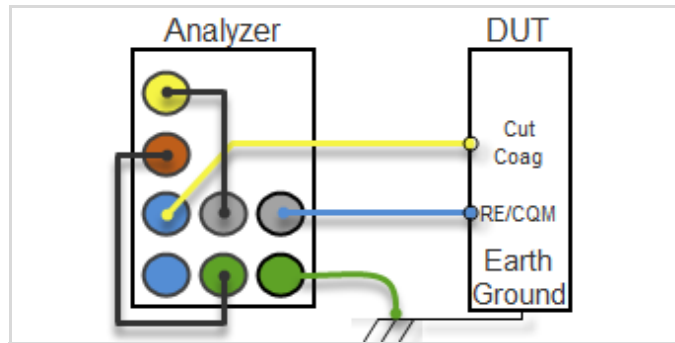

6. Leakage 3 connections

**8.1.4 CQM Cable Differences**

Two CQM cables are provided in delivery, which must be differentiated as they serve different purposes. They look identical except one cable has a small pin and the other does not:



cable without pin

Disables REM (bypasses the REM circuit and allows for shorting of the REM leads).

For testing modes in which the dispersive ports on the device are shorted together, this cable must be used.



cable with pin

Enables REM circuitry on the DUT.

When using the device's CQM test mode, this cable must be used.

**8.1.5 Footswitch**

The footswitch output enables the device to simulate a footswitch to trigger the DUT.

**Output Connections**

The output is provided on the front panel using a 12 pin locking connector. The mating connector is manufactured by Hirose, part number HR10A-10P-12P(74).

**Pin Configuration for the Connector**

Pin	Function	Use
1	relay 1	cut
2		
3	relay 2	coag
4		
5	relay 3	bipolar
6		
7	no connect	
8		
9		
10		
11		
12		

**Unterminated Footswitch Cable**

The unterminated footswitch cable is an optional accessory (Z699A). Connections for each wire:

Color	Function	Use
brown	relay 1	cut
red		
pink	relay 2	coag
yellow		
green	relay 3	bipolar
blue		
violet	no connect	
gray		
white		
black		
red/blue		
gray/pink		

## 8.2 Measuring RF Energy

To measure/test the RF output of a DUT, proceed as follows.

1. Connect the device and the DUT.  
If you need help, tap **Test Setup**. A help screen will show the connection diagram.
2. In the main menu, tap **Measure RF Energy**.  
The **Measure RF** menu appears.
3. Configure the measurement settings:
  - **Display Parameters:** Allows you to select the number of measurements, or zones, that are shown on the screen.  
6 screen configurations are available, 5 display screens which have 1, 2, 3, 4 and 5 display zones respectively, and a sixth screen which shows all measurements available for signals.  
Each display zone can be customized to show any desired parameter available for the current input mode.
  - **Averaging:** Allows you to select the **FAST**, **MEDIUM**, or **SLOW** averaging mode.  
Fast averaging will provide a quick response to incoming signals.  
Slow averaging will provide a more stable display, but will be slower to respond to small changes in the RF input signal.  
The value for the averaging settings can be configured ⇨ 17.
  - **Test Load:** Opens the **Load Configuration** menu where you can select the internal load mode, external load mode, or the combination of internal/external loads.  
The menu also allows for the selection of the internal and external load values.
  - **Configure Footswitch:** Triggers the footswitch output for the duration that is configured in the **Configure Footswitch** menu. Tap **Configure Footswitch** to set up; see left.  
To deactivate it before the activation timeout period, tap button a second time.  
While it is active, the button will remain highlighted with a yellow background.
  - **HOLD:** Toggles the hold mode. Measurements are not updated while in hold mode.
4. Trigger the DUT.  
↳ The mA measurement will be shown on the screen.  
To change the displayed measurement, tap **mA**. By tapping it repeatedly, you can toggle through the various measurements.

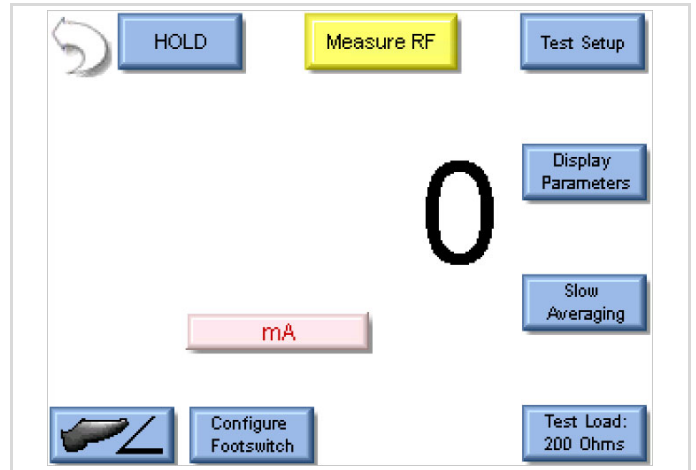

Fig. 18: Measure RF menu

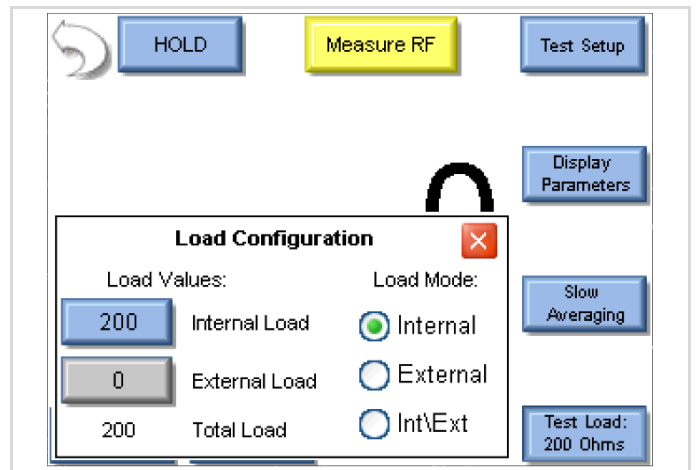

Fig. 19: Load configuration menu

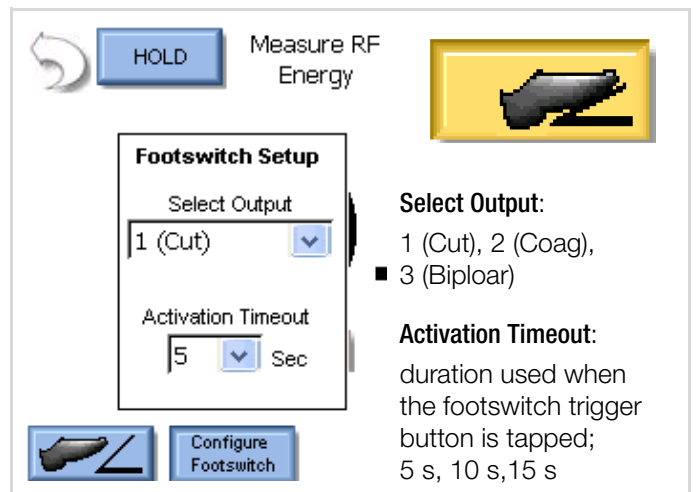

Fig. 20: Footswitch setup (left) and activated footswitch above

**Note!**

To abort and get back to the main screen, tap the back arrow.

## Measurement / Test Parameters

Parameter	Abbreviation	Description
V Load	V	Load voltage calculated by the load resistance and current measurement.
mA	mA	Converted mA measurement based on the RF transformer mV to mA attenuation ratio.
Power in Watts	Watts	Computed power based on load setting and mA measured.
V Peak	V Pk	$V_{\max}$ measured in the buffer. Is shown as an absolute value.
V Peak–Peak	V P-P	Difference between $V_{\max}$ measured and $V_{\min}$ measured.
V Peak / Peak–Peak	Vp/P-P	Ratio of Peak divided by Peak to Peak voltage.
V Positive Peak Only	V Pk+	Maximum positive voltage measured in the buffer. For asymmetric waveforms this can determine if the output polarity is reversed.
Crest Factor	CF	Ratio of peak to rms of the measured waveform.
Frequency	kHz	Frequency of the measured waveform.

## Example 1

I need to measure monopolar current with a 500  $\Omega$  load. I don't have a footswitch cable, so I will trigger the DUT myself.

1. Connect the active output from the DUT to the active input on the device with the yellow lead.
2. Connect the dispersive or return port on the DUT to the dispersive 1 and dispersive 2 inputs on the device with the blue cable without pin.
3. In the main menu, tap **Measure RF Energy**.  
The **Measure RF** menu appears.
4. Tap **Test Load**.  
The **Load Configuration** menu appears.

**Note!**

The device can be configured to use internal loads, external loads, or a combination of both.

First select the **Load Mode**, then enter the desired internal and external loads. The total load will automatically be updated. For most testing, internal loads are sufficient.

5. Trigger the DUT.  
↳ The mA measurement will be shown on the screen.  
To change the displayed measurement, tap **mA**. By tapping it repeatedly, you can toggle through the various measurements.

## Example 2

I need to measure mA and Watts of a bipolar output with a 300  $\Omega$  load. I want to trigger the DUT with the footswitch output.

1. Connect one bipolar output from the DUT to the active input on the device with the yellow lead.
2. Connect the other bipolar output port from the DUT to the dispersive 1 input on the device using the blue cable with banana jacks on each end (not the CQM/RECQM cable).
3. In the main menu, tap **Measure RF Energy**.  
The **Measure RF** menu appears.
4. Tap **Test Load**.  
The **Load Configuration** menu appears.
5. Tap the **Internal Load** button and enter 300.  
The menu automatically closes.
6. Tap **Display Parameters**.  
The **Select Screen** menu appears.
7. Tap **Two Readings**.  
The menu automatically closes.
8. Tap **Configure Footswitch**.  
The **Footswitch Setup** menu appears.
9. From the **Select Output** list, select 3 (Bipolar).
10. From the **Activation Timeout** list, select the maximum time after which the DUT will be triggered.
11. Tap **Configure Footswitch**.  
The **Footswitch Setup** menu closes.

**Note!**

The footswitch output selection is only valid for footswitch cables that are designed for a specific DUT, such as the BC20-03001 or BC20-03002.

If you are using the unterminated footswitch cable, BC20-03000, the output selection is dependent on how the cable is wired.

12. Tap the footswitch button to trigger the DUT.

↳ The measurement will be shown on the screen.

To change the displayed measurement, tap **mA** respectively **Watts**. By tapping it repeatedly, you can toggle through the various measurements.

You may either wait for the footswitch activation timeout, or tap the footswitch button again to stop triggering the DUT output.

### 8.3 Measuring RF Leakage

The device can measure/test 4 RF leakage modes:





Mode	Description
Leakage 1a	<p>Leakage test, specified by the IEC as Active Electrode to Ground for testing the RF leakage to earth ground of an isolated output type CF electro-surgical generator from a single active or dispersive lead.</p> <p>The purpose of this test is to verify that open circuit RF leakage of the DUT meets or exceeds the IEC specification.</p> <p>The test complies with IEC 601-22, section 201.8.7.3.101 a) 2), figure 201.106 for monopolar tests (active lead) and section 201.8.7.3.101 a) 3), figure 201.107 for bipolar tests (bipolar lead 1).</p> <hr/> <p> <b>Attention!</b> ONE LEAD AT A TIME! Only test one lead of the DUT at a time, either active or dispersive, not both.</p> <hr/> <p> <b>Note!</b> Not for testing an earth references type BF electro-surgical generator! (Measurement/test will be erroneous.)</p>
Leakage 1b	<p>Leakage test, specified by the IEC as Dispersive Electrode to Ground, for testing the RF leakage to earth ground of an isolated output type CF electro-surgical generator from a single active or dispersive lead.</p> <p>The purpose of this test is to verify that open circuit RF leakage of the DUT meets or exceeds the IEC specification.</p> <p>The test complies with IEC 601-22, section 201.8.7.3.101 a) 2), figure 201.106 for monopolar tests (active lead) and section 201.8.7.3.101 a) 3), figure 201.107 for bipolar tests (bipolar lead 1).</p> <hr/> <p> <b>Attention!</b> ONE LEAD AT A TIME! Only test one lead of the DUT at a time, either active or dispersive, not both.</p> <hr/> <p> <b>Note!</b> Not for testing an earth references type BF electro-surgical generator! (Measurement/test will be erroneous.)</p>
Leakage 2	<p>Leakage test, specified by the IEC as earth reference leakage type BF (load between electrodes), is for testing the leakage to earth ground of a ground referenced output type BF electro-surgical generator from the active output.</p> <p>The purpose of this test is to verify that the RF leakage of the DUT meets or exceeds the IEC specification.</p> <p>This test complies with IEC 601-2-2, section 201.8.7.3.101 a) 1) test 1, figure 201.104 for monopolar tests and section 201.8.7.3.101 a) 3), figure 201.107 for bipolar tests.</p>
Leakage 3	<p>Leakage test, specified by the IEC as earth reference leakage type BF (load from active electrode to earth) is for testing the leakage to earth ground of a ground referenced output type BF electro-surgical generator from the active output.</p> <p>The purpose of this test is to verify that the RF leakage of the DUT meets or exceeds the IEC specification.</p> <p>This test complies with IEC 601-2-2, section 201.8.7.3.101 a) 1) test 2, figure 201.105 for monopolar tests.</p>

Tabelle 13: RF leakage measurement types

To measure/test the RF leakage of a DUT, proceed as follows.

1. Connect the device and the DUT.
  - If you need help, tap **Test Setup**. A help screen will show the connection diagram for the RF measurement mode.
2. In the main menu, tap **Measure RF Leakage**.  
The **Measure RF Leakage** menu appears.
3. Configure the measurement settings:
  - **Leakage mode** (green): Allows you to select one of the 4 leakage measurement modes to be used: Leakage 1a, Leakage 1b, Leakage 2, or Leakage 3 → table 13 29.
  - **Display Parameters**: Allows you to select the number of measurements, or zones, that are shown on the screen.  
6 screen configurations are available, 5 display screens which have 1, 2, 3, 4 and 5 display zones respectively, and a sixth screen which shows all measurements available for signals.  
Each display zone can be customized to show any desired parameter available for the current input mode.
  - **Averaging**: Allows you to select the FAST, MEDIUM, or SLOW averaging mode.  
Fast averaging will provide a quick response to incoming signals.  
Slow averaging will provide a more stable display, but will be slower to respond to small changes in the RF input signal.  
The value for the averaging settings can be configured → 17.
  - **Test Load**: Opens the **Load Configuration** menu where you can select the internal load mode, external load mode, or the combination of internal/external loads. The menu also allows for the selection of the internal and external load values.
  - **Configure Footswitch**: Triggers the footswitch output for the duration that is configured in the **Configure Footswitch** menu. Tap **Configure Footswitch** to set up; see left.  
To deactivate it before the activation timeout period, tap button a second time.  
While it is active, the button will remain highlighted with a yellow background.
  - **HOLD**: Toggles the Hold mode. Measurements are not updated while in hold mode.

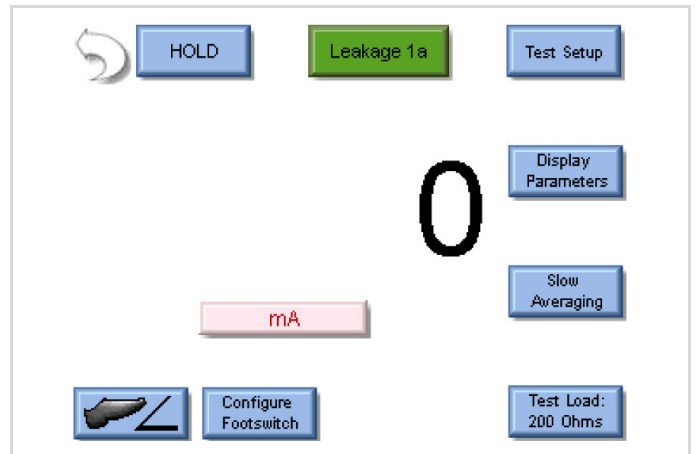

Fig. 21: Measure RF menu

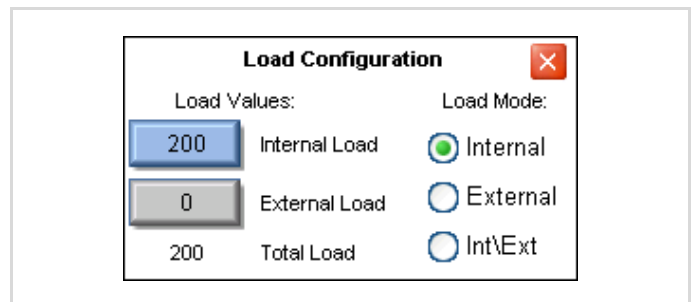

Fig. 22: Load configuration menu

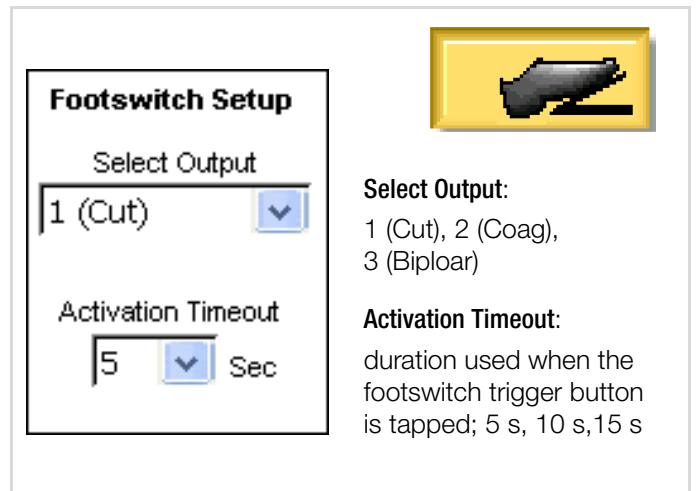

Fig. 23: Footswitch setup (left) and activated footswitch above

4. Trigger the DUT.
  - ↳ The mA measurement will be shown on the screen.  
To change the displayed measurement, tap **mA**. By tapping it repeatedly, you can toggle through the various measurements.

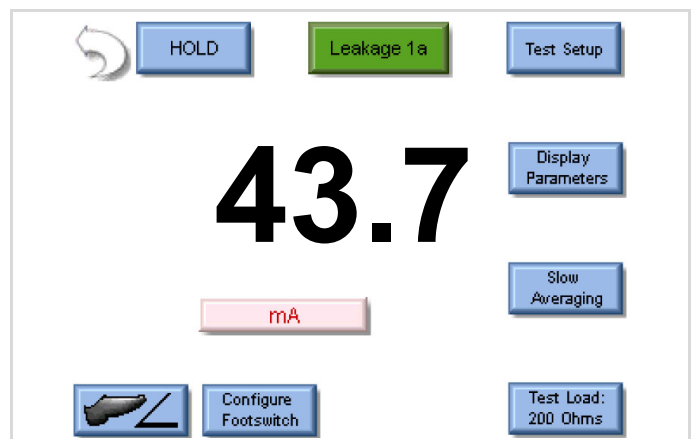

Fig. 24: RF leakage measurement result

**Example 1: Leakage 1a Measurement**

I need to measure the leakage current from an Active lead to ground of DUT that is a type CF electro-surgical generator.

1. Connect the device and the DUT:
  - Connect the active output from the DUT to the active input on the device using the yellow lead.
  - Connect the earth ground port on the device to the ground lug on the back of the DUT using the green cable and green alligator clip.
  - Connect one of the dispersive ports on the device to the other earth ground port on the device using the black cable.If you need help, tap **Test Setup**. A help screen will show the connection diagram.
2. In the main menu, tap **Measure RF Leakage**.  
The **Measure RF Leakage** menu appears.
3. Tap **Leakage mode** and set to **Leakage 1a**.
4. Trigger the DUT.
  - ↳ The mA measurement will be shown on the screen.
  - To change the displayed measurement, tap **mA**. By tapping it repeatedly, you can toggle through the various measurements.

**Example 2: Leakage 1b Measurement**

I need to measure the leakage current from the dispersive (REM) port to ground.

1. Connect the device and the DUT:
  - Connect the dispersive output from the DUT to the active port on the device using the CQM cable without the center pin and a single electrode.
  - Connect earth ground port on the device to the ground lug on the back of the DUT using the green cable and green alligator clip.
  - Connect one of the dispersive ports on the device to the other earth ground port on the device using the black cable.If you need help, tap **Test Setup**. A help screen will show the connection diagram.
2. In the main menu, tap **Measure RF Leakage**.  
The **Measure RF Leakage menu** appears.
3. Tap **Leakage mode** and set to **Leakage 1b**.
4. Trigger the DUT.
  - ↳ The mA measurement will be shown on the screen.
  - To change the displayed measurement, tap **mA**. By tapping it repeatedly, you can toggle through the various measurements.

**Example 3: Leakage 2 Measurement**

I need to measure the leakage current from the dispersive (REM) port to ground. I need to have a 200  $\Omega$  load from active to dispersive during the test.

1. Connect the device and the DUT.
  - Connect the active output from the DUT to the dispersive port on the device using the yellow lead.
  - Connect the dispersive output from the DUT to the loop port on the device using the CQM cable without the center pin and single electrode.
  - Connect earth ground port on the device to the ground lug on the back of the DUT using green cable and green alligator clip.
  - Connect the active port on the device to one of the aux load ports on the device using the black cable.
  - Connect the other aux load port on the device to one of the earth ground port on the device using the black cable.If you need help, tap **Test Setup**. A help screen will show the connection diagram.
2. In the main menu, tap **Measure RF Leakage**.  
The **Measure RF Leakage menu** appears.
3. Tap **Leakage mode** and set to **Leakage 2**.
4. Trigger the DUT.
  - ↳ The mA measurement will be shown on the screen.
  - To change the displayed measurement, tap **mA**. By tapping it repeatedly, you can toggle through the various measurements.

**Example 4: Leakage 3 Measurement**

I need to measure the leakage current from the dispersive (REM) port to ground. I need to have a 200  $\Omega$  load from active to ground during the test.

1. Connect the device and the DUT.
  - Connect the active output from the DUT to the active input on the device using the yellow lead.
  - Connect the dispersive output from the DUT to the dispersive inputs on the device using the blue cable without the center pin.



- Connect earth ground port on the device to the ground lug on the back of the DUT using the green cable and green alligator clip.
- If you need help, tap **Test Setup**. A help screen will show the connection diagram.
2. In the main menu, tap **Measure RF Leakage**.  
The **Measure RF Leakage** menu appears.
  3. Tap **Leakage mode** and set to **Leakage 3**.
  4. Trigger the DUT.
- ↳ The mA measurement will be shown on the screen.  
To change the displayed measurement, tap **mA**. By tapping it repeatedly, you can toggle through the various measurements.

## 8.4 Power Load Curves

The power load curve allows you to test and graph the power output of the DUT.

The loads used and DUT power settings are programmable. If desired, the device can be configured to trigger the DUT using one of the three footswitch relay outputs.

You can save created power load curves (\*ldc) to run them repeatedly.

Measurement/test results can also be saved: As a curve file (\*.crv) and view them later.

### 8.4.1 Configure and Run Power Load Curves

1. Connect the device and the DUT.  
If you need help, tap **Test Setup**. A help screen will show the connection diagram.
2. In the main menu, tap **Power Load Curves**.  
The **Load Curve** menu appears.
3. Tap **Configure Load Curve**.  
The **Load Curve Configuration** menu appears.
4. Configure the measurement parameters for loads, power, meter, and DUT:
  - **Setup Loads:** The loads can be configured as either a step based load change or a list based load change. For step based loads, enter the first load to be used and the last load to be used. Then the device will step the loads by either a fixed resistance or by a calculated amount to achieve a fixed number of steps for the test.  
Step based loads allows you to select specific resistances to be used.
  - **Setup Power:** The device can run the load curve at a single power level or multiple power levels. The single power level allows you to set the desired DUT power setting. With multiple power levels, you can select either step based power levels based on a fixed change in watts or based on the number of desired steps in the test.
  - **Meter:** Sets the measurement averaging rate mode for the load curve.
  - **DUT:** Selects the trigger mode for the DUT. Either operator, then the user will be prompted when to activate or deactivate the DUT, or by device, then the desired footswitch output to be used must be selected.

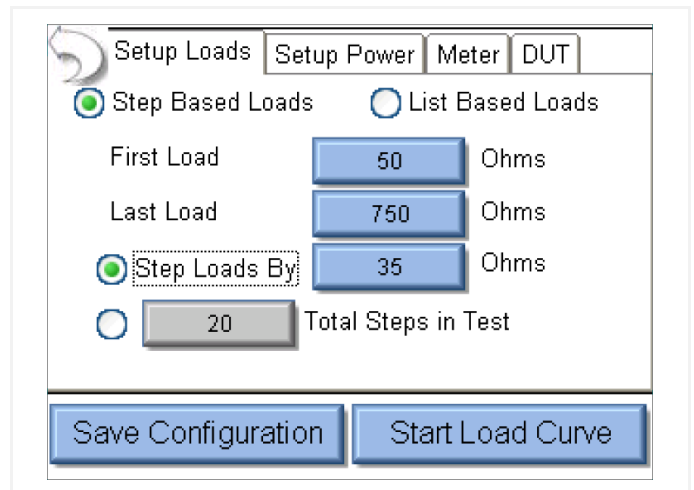

Fig. 25: Load curve configuration menu

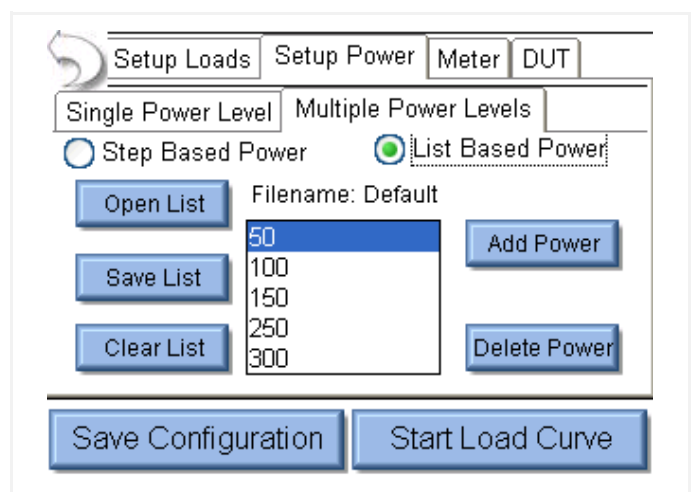

Fig. 26: Setup for list based multi power levels

5. Start the load curve measurement by tapping **Start Load Curve**.
  - ↳ The load curve runs and the screen will be updated with the measured power from the DUT.
    - To view individual data points, tap **View Data**. To exit this display, tap **Close**.
    - To save the measurement, tap **Save Data** and follow the on-screen prompts.

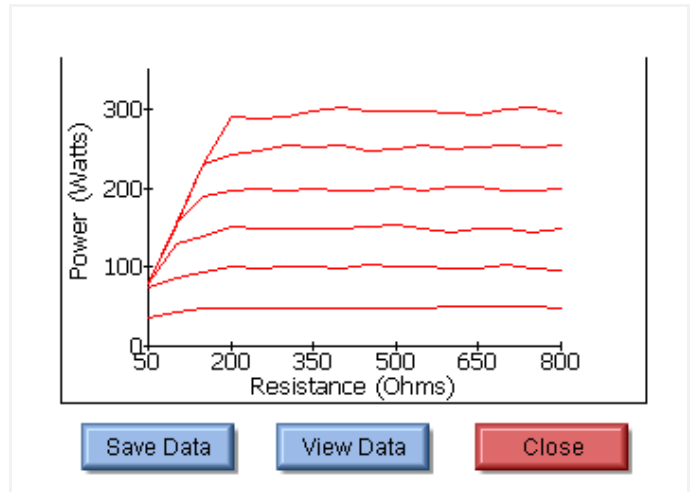

Fig. 27: Load curve measurement result

File	Load	50W	100W	150W	200W
▶	50	36.5	75.1	78.3	78.3
	100	42.9	86.9	128.9	155.5
	150	48.2	94.4	139.9	188.4
	200	47.7	99.6	150.0	196.2
	250	49.0	99.1	149.4	197.9
	300	48.0	100.5	149.1	195.5
	350	47.4	99.8	149.8	198.8
	400	49.1	98.7	148.7	196.6

Fig. 28: Load curve view of individual data points

**Example 1**

I need to run a bipolar load curve at 60 Watts with loads from 100 to 1000 Ω, measuring every 100 Ω. I am testing a Covidien ForceFx and will want the device to trigger the DUT.

1. Connect the device to the DUT.
  - Connect the yellow cable to the active port on the device and to one of the bipolar outputs on the DUT.
  - Connect the blue cable to the dispersive 1 port of the device and to the other bipolar output on the DUT.
2. Connect the BC20-03001 footswitch cable from the DUT to the device.
3. In the main menu, tap **Power Load Curves**.  
The **Load Curve** menu appears.
4. Tap **Configure Load Curve**.  
The **Load Curve Configuration** menu appears.
5. Tap the **Setup Loads** tab.  
The settings appear.
6. Select **Step Based Loads**.
7. Select **Step Loads By**.
8. Tap the blue resistance button and enter 100.
9. Tap the **Setup Power** tab.  
The settings appear.
10. Tap the **Single Power Level** tab.  
The settings appear.
11. Tap the blue button and enter 60.
12. Tap the **DUT** tab.  
The settings appear.
13. Select **ESTech**.

14. In the **Footswitch Output** list, select **3**.
  15. Start the load curve measurement by tapping **Start Load Curve**.
- ↳ The load curve runs and the screen will be updated with the measured power from the DUT.
- To view individual data points, tap **View Data**. To exit this display, tap **Close**.
  - To save the measurement, tap **Save Data** and follow the on-screen prompts.



### Note!

Instead of running the measurement, you can also save it to a file for future use: Tap **Save Configuration** and follow the on-screen prompts.

### Example 2

I need to run a pure cut 300 W load curve, but there isn't a footswitch cable available for my DUT. In addition, I need to test my DUT at 50 Ω, 300 Ω, 500 Ω, 800 Ω, and 1500 Ω.

1. Connect the device and the DUT.
  - Connect the active port on the device to the active output on the DUT using the yellow cable.
  - Connect the dispersive ports of the device to the return on the DUT using the CQM cable.
2. In the main menu, tap **Power Load Curves**.  
The **Load Curve** menu appears.
3. Tap **Configure Load Curve**.  
The **Load Curve Configuration** menu appears.
4. Tap the **Setup Loads** tab.  
The settings appear.
5. Select **List Based Loads**.
6. Tap **Clear List**.  
All of the previous settings from the list of loads to be used are removed.
7. Tap **Add Load**.  
The number pad appears.
8. Enter **50**.
9. Repeat the two previous steps to enter the values for the other loads to be used: 300, 500, 800, 1500.
10. Tap the **Setup Power** tab.  
The settings appear.
11. Tap the **Single Power Level** tab.  
The settings appear.
12. Tap **Enter DUT Power Setting**.  
The number pad appears.
13. Enter **300**.
14. Tap the **DUT** tab.  
The settings appear.
15. In the **DUT Activation** area, tap **Operator**.
16. Optional: To save the measurement settings for future repeated use, tap **Save Configuration**.  
The settings are saved.
17. Tap **Start Load Curve**.  
↳ The measurement starts. You will be prompted when to start and stop triggering the generator.

### 8.4.2 Run Previously Configured Load Curve

If you previously configured and saved a load curve, you can call that saved configuration and run it (again).

- ✓ At least one load curve has been previously configured and saved in the device ⇨ 32.

1. In the main menu, tap **Power Load Curves**.  
The **Load Curve** menu appears.
  2. Tap **Run Saved Load Curve**.  
The **Select File to Load** dialog appears.
  3. Select the file.
  4. Tap **OK**.  
The **Load Curve** menu appears.
  5. Tap **Start Load Curve**.
- ↳ The load curve runs and the screen will be updated with the measured power from the DUT.
- To view individual data points, tap **View Data**. To exit this display, tap **Close**.
  - To save the measurement, tap **Save Data** and follow the on-screen prompts.

### 8.4.3 View Saved Power Load Curves

You can display the load curve measurement that were previously saved in the device.

✓ At least one load curve has been run and its results have been saved in the device → 32.

1. In the main menu, tap **Power Load Curves**.

The **Load Curve** menu appears.

2. Tap **View Saved Curve Data**.

– The curve data is displayed.

To view details, tap **View Data**. Tap **View Data** again, to close the details.

Tap **Close** to return to the **Load Curve** menu.

## 8.5 REM/ARM/CQM (Return Electrode Control Quality Monitor Test)

REM/ARM/CQM (Return Electrode Control Quality Monitor Test) allows you to control the resistance between the blue CQM terminals on the front of the device.

You can set a value manually or choose auto mode, in which the resistance will change by 1  $\Omega$  increments at the speed selected.

### 8.5.1 Manual Mode

1. In the main menu, tap **REM/ARM/CQM**.

The **REM/ARM/CQM** menu appears.

2. Tap **Manual**.

Manual mode is selected.

3. Change the QM resistance:

– Enter as number: Tap **Resistance in Ohms** and enter the value as a number. Maximum = 500  $\Omega$ .

– Adjust up/down in steps: Tap the **Change By Ohms** number button to define the step and then tap up or down arrow. Maximum = 500  $\Omega$ .

– Percentage: Tap the **Change By Percent** number button to define the percentage and then tap up or down arrow to adjust by a percentage of the current resistance. Maximum = 500% / minimum change = 1  $\Omega$ .

Example: Current resistance = 1  $\Omega$ . Change percentage = 1. Tapping the arrow will change the resistance by 1  $\Omega$  up or down.

– Reset to 0: Tap **Zero Ohms**.

– Set to open circuit: Tap **Open Circuit**.

↳ The QM resistance is set.

### 8.5.2 Auto Mode

1. In the main menu, tap **REM/ARM/CQM**.

The **REM/ARM/CQM** menu appears.

2. Tap **Auto**.

Auto mode is selected.

3. Set the initial QM resistance:

– Tap **Resistance in Ohms** and enter the value as a number. Maximum = 500  $\Omega$ .

– Reset to 0: Tap **Zero Ohms**.

The QM resistance is set.

4. Set the speed with which the CQM resistance will change: From the **Auto Speed** list, select 1 to 5 seconds.

5. Start auto mode:

– Increasing the resistance: Tap **Auto Up** to increase the resistance until the max of 500  $\Omega$  is reached.

– Decreasing the resistance: Tap **Auto Down** to decrease the resistance until 0  $\Omega$  is reached.

↳ Auto mode is started.

### 8.5.3 Examples

#### Example 1

I need to test the REM function on my DUT. Its service manual says that the REM alarm is nominal at 35  $\Omega$ .

1. Connect the dispersive output from the DUT to the dispersive inputs on the device. To do so, use the blue cable with the center pin.
  2. In the main menu, tap **REM/ARM/CQM**.  
The **REM/ARM/CQM** menu appears.
  3. Tap **Manual**.  
Manual mode is selected.
  4. Change the QM resistance by entering as number: Tap **Resistance in Ohms** and enter 35 as a number.  
The QM resistance is set.
- ↳ The measurement starts automatically. The DUT REM state is normal when the DUT works fine.

#### Example 2

I need to test the REM function on my DUT. Its service manual says that the REM alarm is nominal at 50  $\Omega$ . An alarm is supposed to occur if the resistance increases by 40%.

1. Connect the dispersive output from the DUT to the dispersive inputs on the device. To do so, use the blue cable with the center pin.
  2. In the main menu, tap **REM/ARM/CQM**.  
The **REM/ARM/CQM** menu appears.
  3. Tap **Manual**.  
Manual mode is selected.
  4. Change the QM resistance by entering as number: Tap **Resistance in Ohms** and enter 50 as a number.  
The QM resistance is set.  
The measurement starts automatically. The DUT REM state is normal when the DUT works fine.
  5. Change the QM resistance as percentage: Tap the **Change By Percent** number button to define a percentage of 40.
  6. Tap the **Change By Percent** up arrow.
- ↳ The resistance will increase by 40% (to 70  $\Omega$ ). The DUT's REM alarm goes off when the DUT works fine.

## 8.6 Autosequences

An autosequence is a programmable procedure for performing testing on a DUT. It can consist of any combination of RF measurements, load curves, CQM tests and/or instructions to the user.

Created autosequences can be saved as "AutoSequence Setup file" (\*.ase) or "Secure AutoSequence" (\*.sse). Whereas standard setup files can be modified later on, secure files cannot be modified after saving.

Measurement/test results can also be saved: As as test file (\*.tst) or as PDF (\*.pdf). PDFs can be added to the DUT's file in order to document how the DUT was tested.

### 8.6.1 Creating an autosequence

The basic procedure of how to create an autosequence is described first to give a general understanding of the process. The individual menu items and steps including parameters that can be defined are described below.

#### Basic procedure

- ✓ An external USB keyboard is connected to the device.
  - 1. In the main menu, tap **Autosequences**.  
The **Autosequences** main menu appears.
  - 2. Tap **Create New Autosequence**.  
The **Autosequences** sub menu appears.
  - 3. Enter all the steps and configure their parameters.
    - Tap **Add**.
    - Select the desired location.
    - Tap **OK**.
    - Enter the desired type of step: **Instruction Only**, **Load Curve**, **RF Leakage / Energy**, or **REM/ARM/CQM**.
    - Tap **Title** and enter the desired step name.  
You need an external USB keyboard for this or you have to use the remote mode to enter through your PC (⇒ 44).
    - Tap the text box **Enter Instructions to Operator Below** and enter any instructions that the user might need to perform at this step.  
You need an external USB keyboard for this or you have to use the remote mode to enter through your PC (⇒ 44).
    - Configure the step parameters, see below ⇒ "Menu" 37.
  - 4. Save the created autosequence by tapping the **save button**.  
The **Save** dialog appears. You can save the autosequence as
    - AutoSequence Setup file (\*.ase): standard
    - Secure AutoSequence" (\*.sse): cannot be modified after saving
    - PDF (\*.pdf)
- ↳ The created autosequence has been saved.

#### Menu

##### General:

- Add Step** Shows the add step dialog box. To add a step to the autosequence, select where to add the step and then tap **OK**.
- Delete Step** Deletes the selected step from the autosequence.
- Copy Step** Copies the selected step. When copying a step, select where to place the new step and then tap **OK**.
- Edit Step** Allows you to edit the selected step:  
Each step has a field for the step **Title** and **Instructions to Operator**.  
Each step can be configured as an **Instruction Only**, **RF Energy / Leakage**, **Load Curve**, or **REM/ARM/CQM** step by selecting it respectively.

##### DUT setup:

- DUT Activation:** For RF Energy / Leakage and Load Curve steps, you have to configure how the DUT will be triggered: by the Operator or the device.
- Operator** When **Operator** is selected, the user will be prompted when to activate or deactivate the DUT.
- EStech** When **EStech** is selected, the activation can be setup manually using the **Footswitch Output** option: 1 (Cut), 2 (Coag), 3 (Bipolar).
- Auto Advance on Pass** Allows for automatically stepping through the autosequence if a measurement passes the tolerance limits that are configured for the selected step.

**Auto Capture** When enabled, the DUT output will automatically be captured and validated when the current step is reached during the autosequence.  
If unchecked, the autosequence will show instructions to the user and the user must manually select the meter display and capture an RF measurement.

#### RF Energy / Leakage:

All of the options in the standard RF measurement and leakage modes are available. You have to configure both the device as well as the measurement tolerance. You can select either through the option at the bottom of the screen.

#### **Tolerance:**

**DUT Output Mode** Identifies the output mode used. (Information only / just displayed.)

**DUT Output Type** Identifies the type of output to be measured. (Information only / just displayed.)

**DUT Power Setting** Represents what the DUT should be set to for the current step.

**Expected Reading** Defines how the device determines whether a measurement passes or fails: **Equal To (%)**, **Less Than, Greater Than**, or **Equal To (Value)**.

**Measurement Units** Selects what is to be measured for the current step. Available measurements ⇒ "Measuring RF Energy" 26.

**High / Low Limit** Determine the limits of the measurement:  
**Equal To (%)** = Limits will be based on a percentage of the expected reading.  
**Equal To (Value)** = Limits will be based on a measurement offset from the expected reading. The numbers in parenthesis below the measurement units display the reading limits based on expected value settings and High/Low Limits.

**Allow Operator to Select Pass/Fail** The tolerances set will determine the pass or fail status of the captured measurement during the autosequence. However, in some cases it may be useful to allow the user to select the pass/fail status of a particular measurement.  
If this box is unchecked, the operator will not be allowed to modify the pass/fail status of the measurement

#### Load Curve:

All of the options in the standard load curve are available.

**Setup Loads** The loads can be configured as either a step based load change or a list based load change.  
For step based loads, enter the first load to be used and the last load to be used. Then the device steps the loads by either a fixed resistance or by a calculated amount to achieve a fixed number of steps for the test.  
For list based loads, you can select specific resistances to be used for the test. The list can be saved to a file or loaded from a previously saved list. The loads are automatically sorted by value as they are added to the list.

**Setup Power** Sets the device to run the load curve at a single power level or multiple power levels.  
**Single Power Level Tab:** Tap **Enter DUT Power Settings (Watts)** to enter the desired power level for the load curve test.  
**Multiple Power Levels Tab:** Defines **Step Based Power** or **List Based Power** levels.  
Step based power levels based can be a fixed change in watts or based on the number of desired steps in the test.  
List based power levels can be any combination of power settings to use for the load curve. The list can be saved to a file or loaded from a previously saved list. The power settings are automatically sorted by value as they are added to the list.

**Setup Meter** Defines the measurement mode for the load curve through the selection of the **Averaging Rate**. This setting is adjustable to match the waveform or DUT being tested.

#### REM/ARM/CQM:

REM/ARM/CQM autosequence steps can be configured as manual or automatic tests.

**Manual CQM Step** You configure the initial CQM resistance. When the test is running, the operator will need to determine whether the CQM test is passed or failed.  
**Allow user to modify QCM resistance during test** determines whether the operator will be allowed to modify the defined QCM resistance or not.



**Auto CQM Step**

Allows for greater automation of the autosequence: Steps can be configured as a single resistance test point or as an automatic sweep of CQM resistances where the CQM status is tested for normal or alarm conditions.

**Single Value Tab:** Applies a single resistance to the DUT CQM circuit and determines whether the step passes or fails based on the expected status.

- **Auto Advance on Pass:** Allows for automatically stepping through the autosequence if the CQM status matches the expected setting.
- **Auto Start CQM Test:** When enabled, the device will automatically trigger the CQM state evaluation to determine if the step passes or fails. If this option is disabled, the operator will have to trigger the CQM test.

**Step Values Tab:** Configures a series of CQM resistances to be stepped through. The CQM resistance can be configured to step by a fixed resistance amount or by a fixed number of steps across a range of resistances. At each step, the DUT CQM state is evaluated. The test can be configured to stop when either an alarm or normal CQM state occurs.

- **Set Tolerance:** Determines the pass / fail parameters. The CQM resistance will be stepped until the CQM state is either normal or alarm as programmed in the step. This point is called the trip resistance and allows you to configure the trip points that result in a pass or fail status for the test.
- **Auto Advance on Pass:** Allows for automatically stepping through the autosequence if the CQM status matches the expected setting.
- **Auto Start CQM Test:** When enabled, the device will automatically trigger the CQM state evaluation to determine if the step passes or fails. If this option is disabled, the operator will have to trigger the CQM test.

**List Values Tab:** Configure a list of CQM resistances that are used in the test. During the test the CQM resistance will be sequentially set to the values shown in the CQM resistance list. The step can be configured to stop when the CQM state is either alarm or normal.

- **Set Tolerance:** Determines the pass / fail parameters. The CQM resistance will be stepped until the CQM state is either normal or alarm as programmed in the step. This point is called the trip resistance and allows you to configure the trip points that result in a pass or fail status for the test.
- **Auto Advance on Pass:** Allows for automatically stepping through the autosequence if the CQM status matches the expected setting.
- **Auto Start CQM Test:** When enabled, the device will automatically trigger the CQM state evaluation to determine if the step passes or fails. If this option is disabled, the operator will have to trigger the CQM test.

**Example 1: RF Measurement Step**

I need to configure an autosequence step to take an RF current measurement with a 200 Ω load. The measurement tolerance is 315 mA ±25 mA.

✓ An external USB keyboard is connected to the device.

1. In the main menu, tap **Autosequences**.  
The **Autosequence** main menu appears.
2. Tap **Create New Autosequence**.  
The **Autosequences** sub menu appears.
3. Tap **Add**.
4. Select the desired location.
5. Tap **OK**.
6. Select **RF Leakage / Energy** as type of step.
  - Tap **Title** and enter the desired step name.  
E.g. **Monopolar 1 Pure Cut, 200 Ohms**.  
you have to use the remote mode to enter through your PC (⇒ 44).
7. Tap the text box **Enter Instructions to Operator Below** and enter any instructions that the user needs to perform at this step.  
E.g. **DUT output. Connect the dispersive ports of the device to the DUT REM port using the blue cable. Then set the DUT to 100 Watts, pure cut mode.**
8. Tap **Meter Setup**.  
The **Meter** menu appears.
9. Tap **Test Load**.  
The **Load Configuration** menu appears.
10. In the **Load Mode** area, select **Internal**.
11. In the **Load Values** area, tap **Internal Load** and enter 200.



12. Optional: By default, the user will not be able to change the load resistance once the test is running. If you would like for the operator to be able to change the load, tap **Allow Operator to modify load**.
13. Tap **Close**.  
The menu disappears.
14. Tap **Tolerance** at the bottom of the screen.  
The **Tolerance** menu appears.
15. Optional: As information, you can define **DUT Output**, **DUT Mode** and **DUT Power Setting**.  
They do not have any effect on the test or measurement.
16. From the **Expected Reading** list, select **Equal to (Value)**.
17. Tap the number button to the right of **Expected Reading**.  
The number pad appears.
18. Enter 315 in the number pad.



### Note!

If the desired reading were watts or any other measurement taken by the device, the red button to the right of the expected reading can be tapped to change the measurement being tested.

19. Tap **High Limit**.  
The number pad appears.
20. Enter 25 in the number pad.
21. Tap **Low limit**.  
The number pad appears.
22. Enter 25 in the number pad.
23. Optional: If you would like to allow the operator to override the automated limit testing, you can tap **Allow operator to select Pass/Fail Status**.
24. Tap **Back to Step Edit**.
25. Tap **Done**  
↳ The configuration is complete for this step. You are returned to the autosequence summary screen.

### Example 2: Load Curve step

I need to run a pure cut 300 W load curve, and there isn't a footswitch cable available for my DUT. Additionally, I need to take 10 measurements with loads from 50...5000 Ω.

1. In the main menu, tap **Autosequences**.  
The **Autosequences** main menu appears.
2. Tap **Create New Autosequence**.  
The **Autosequences** sub menu appears.
3. Tap **Add**.
4. Select the desired location.
5. Tap **OK**.
6. Select **Load Curve** as type of step.
  - Tap **Title** and enter the desired step name.  
E.g. **Load Curve**.  
You need an external USB keyboard for this or you have to use the remote mode to enter through your PC (⇒ 44).
7. Tap the text box **Enter Instructions to Operator Below** and enter any instructions that the user needs to perform at this step.  
E.g. **This step will run a load curve at 300 Watt with 10 loads ranging from 50 to 5000 Ohms**.  
You need an external USB keyboard for this or you have to use the remote mode to enter through your PC (⇒ 44).
8. Tap **Meter Setup**.  
The **Meter** menu appears.
9. Tap **Setup Loads**.  
The **Setup Loads** tab appears.
10. Tap **Step Based Loads**.
11. Tap **First Load**.  
The number pad appears.
12. Enter 50 in the number pad.
13. Tap **Last Load**.  
The number pad appears.
14. Enter 5000 in the number pad.
15. Tap **Total Steps in Test**.
16. Tap the number button to the left of **Total Steps in Test**.  
The number pad appears.

17. Enter 10 in the number pad.
  18. Tap the **Setup Power** tab.  
The **Setup Power** menu appears.
  19. Tap the **Single Power Level** tab.  
The **Single Power Level** menu appears.
  20. Tap **Enter DUT Power Setting (Watts)**.  
The number pad appears.
  21. Enter 300 in the number pad.
  22. Tap **Back to Step Edit**.
  23. Tap **Done**
- ↳ The configuration is complete for this step. You are returned to the autosequence summary screen.

**8.6.2 Using an Existing Autosequence**

1. In the main menu, tap **Autosequences**.  
The **Autosequence** main menu appears.
  2. Tap **Select Autosequence**.  
The **Select Autosequence File to Open** dialog appears.
  3. Select the autosequence to be opened.  
By selecting the filter type you can, limit the shown autosequences to autosequence setup (\*.ase) or secure autosequence (\*.sse) files only.
  4. Tap **OK**.  
The **Autosequence step** menu is displayed.
  5. Tap **Start Test**.
- ↳ The selected autosequence starts. For information on how to continue see ⇨ "Running an Autosequence" 41.

**8.6.3 Running an Autosequence**

✓ You have created an autosequence ⇨ 37 and opened it ⇨ 41.

1. Tap **Start Test**.  
You are prompted to enter information about the DUT.
2. Enter the requested information.  
Aside from the displayed or external keyboard, you can use a barcode scanner to simplify this step ⇨ "External Devices" 16.
3. Tap the arrow to proceed.

**Please Enter the following information for the test report.**

Generator ID:

Manufacturer:

Model:

Serial Number:

Tested By:

Signature: (Tap to insert signature)

Fig. 29: Enter DUT information

4. Run through the steps of the autosequence.
  - Instruction steps:  
Follow the instructions displayed.  
You must update the status to identify if the step passed or failed.  
You can add notes by tapping the paperclip icon at the bottom of the screen.

**Autosequence Step 1/7 Operator Instruction**  
**Check Front Panel**

Inspect rear panel for any damaged connectors or pins.

Ensure that a footswitch can be plugged into the rear connectors and that the dut responds to the footswitch input.

Show Meter
  Pass
  Fail

Fig. 30: Instruction step

- RF Energy / RF Leakage steps:  
 Read the instructions displayed. Then tap **Show Meter** to perform the measurement.  
 If the step is setup for the operator to trigger the DUT, you must activate the DUT and then tap **Capture** to analyze the measurement and then identify if the step passed or failed.  
 If the step is setup to automatically trigger the generator, simply tap the **Capture** and the DUT will automatically be activated and the step identified as passed or failed.  
 You can re-run the measurement by tapping **New Capture**.  
 You can add notes by tapping the paperclip icon at the bottom of the screen.

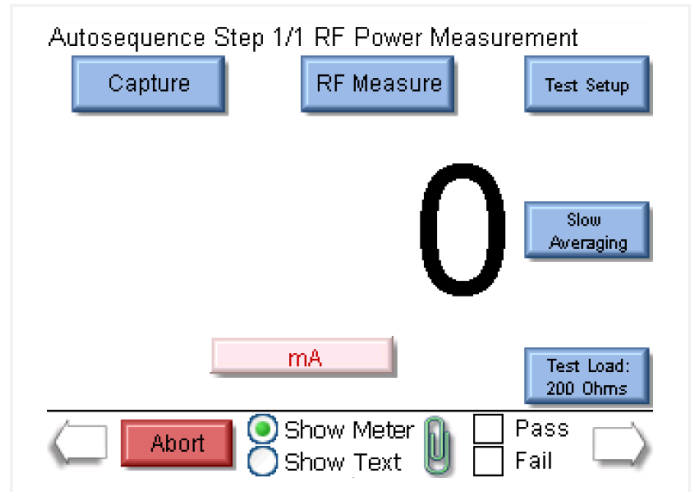

Fig. 31: RF Energy / RF Leakage step:

- Load curve steps:  
 Follow the instructions displayed. The tap **Start Test** to run the load curve.  
 You can view the load curve result. Tap **View Data** for details.  
 Then identify if the step passed or failed.  
 You can re-run the load curve by tapping **Rerun Test**.  
 You can add notes by tapping the paperclip icon at the bottom of the screen.

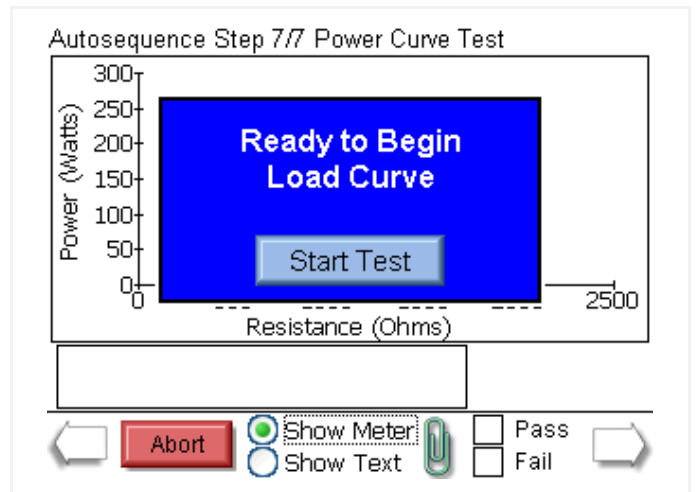

Fig. 32: Load curve step

- Manual CQM steps:  
 Follow the instructions displayed. You are shown the step configuration to allow you to adjust the CQM resistance, the following screen will be shown.  
 You have to identify if the step passed or failed.

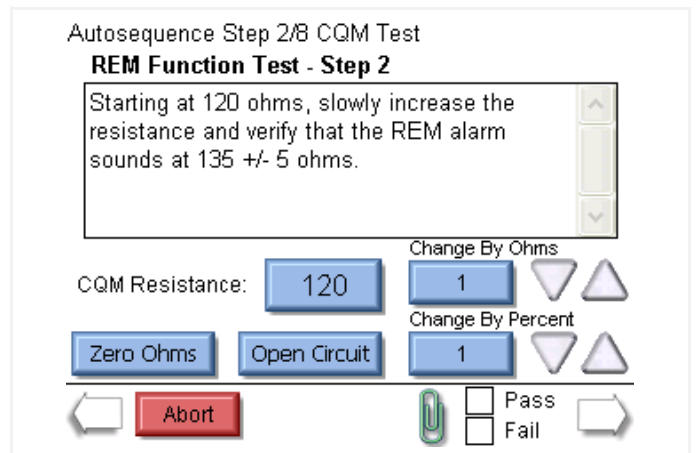

Fig. 33: Manual CQM step

- Auto CQM steps:  
Read the instructions displayed.  
Then tap **Run Auto CQM Test** and the CQM status of the DUT is evaluated to determine whether the step is passed or failed.

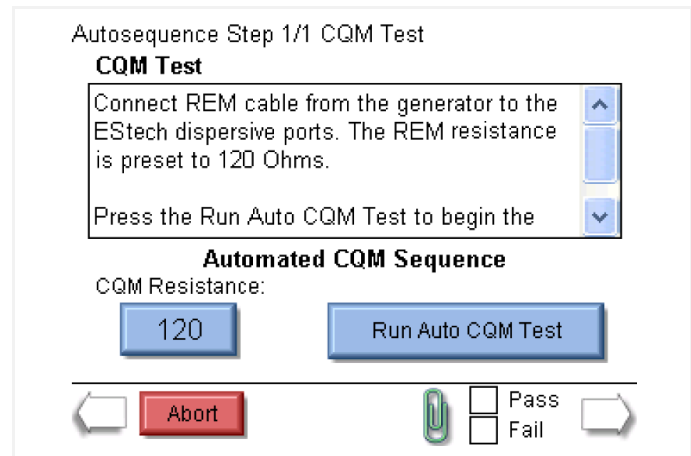

Fig. 34: Auto CQM step

5. After all of the steps have been completed, the result screen is shown.  
It indicates whether the test passed or failed.
  6. Optional: To save the results to a file, tap **Save Results**.  
Follow the on-screen directions.
- ↳ The autosequence has been completed.  
To return to the main autosequence step list, tap **Autosequence Menu**.  
To initiate a new autosequence, tap **Next DUT**. You will be returned to the DUT information screen.  
To take a step back, tap the arrow. You can review the full test.

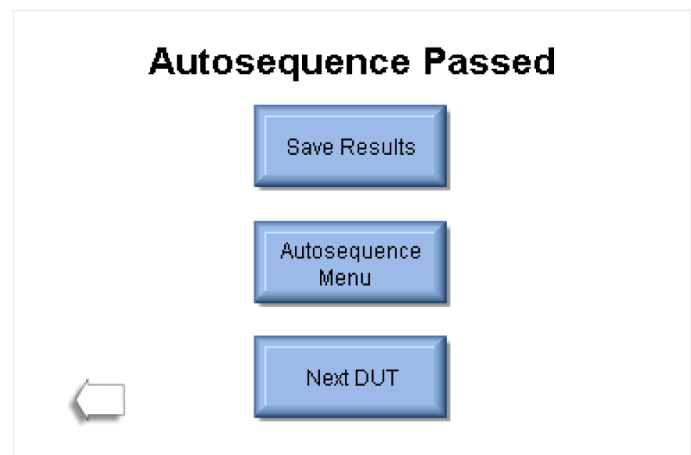

Fig. 35: Autosequence result

#### 8.6.4 Viewing Autosequence Results

If you previously have run autosequences and saved the result(s), you can open and display the result file (\*.tst).

1. In the main menu, tap **Autosequences**.  
The **Autosequence** main menu appears.
  2. Tap **View Saved Test Data**.  
The **Select File to Open** dialog appears.
  3. Select the file to be opened.
  4. Tap **OK**.
- ↳ The result / file content is displayed.  
To return to the main autosequence step list, tap **Autosequence Menu**.  
To initiate a new autosequence, tap **Next DUT**. You will be returned to the DUT information screen.

## 9 Remote Operation

You have two ways of using the device remotely:

1. Remote mode ⇨ 44.
2. Remote control through communication protocol and PC ⇨ 44.

Both provide a hands-free operation of the device. The communication protocol also allows for automated operation.

### 9.1 Remote Mode

You can control the device remotely from a PC, if both the device and PC are connected to the same network.

For remote mode, you will need to set up your PC: The CERHost utility must run on your PC. Once your PC has been set up, you will only need to activate remote mode each time you want to use it.

#### 9.1.1 Setting Up Your PC for Remote Mode (CERHost utility)

The CERHost utility is available on the device. You need to load and install it on your PC.

- ✓ System requirements: Windows 8.1, Windows 10, or Windows 11.
- ✓ Your device is connected to the network your PC is connected to (same IP range) ⇨ 16.
- ✓ You know the network name of your device ⇨ 16.

1. On your PC, open the **Windows File Explorer**.
  2. In the address field, type \\<networkname>\Utility.  
The folder with the utility is displayed.
  3. Load the utility to your PC.
  4. Install the utility on your PC. Do so, run the utility and follow the on-screen prompts.
- ↳ Your PC is set up for remote mode.

#### 9.1.2 Using the Remote Mode

In remote mode, the screen of the device will be displayed in the CERHost utility running on your PC. You can operate the device with the usual means of your PC, i.e. click with the mouse and use a keyboard. You can blank the device screen.

##### Activating the Remote Mode

- ✓ Your device is connected to the network your PC is connected to (same IP range) ⇨ 16.
  - ✓ The CERHost utility is available on your PC ⇨ 44.
1. In the device main menu, tap **System Setup**.  
The **System Setup** menu appears.
  2. Go to the second page.
  3. Tap **Go To Remote Mode**.
  4. Follow the on-screen prompts. They will guide you through the process of starting the CERHost utility on your PC and establishing a connection with the device.
- ↳ The device and PC are connected. The screen of the device is displayed in the CERHost utility and you can operate the device remotely from your PC.

##### Returning to Local Mode (Deactivating Remote Mode)

- ✓ Remote mode is active (see above).
1. In the device main menu, open **System Setup**.  
The **System Setup** menu appears.
  2. Go to the second page.
  3. Click **Go To Local Mode**.
- ↳ Remote mode is deactivated. You must now operate the device locally.

### 9.2 Remote control with Communication Protocol and PC

The communication protocol provides a means to completely configure and use the device from a PC: All functions available through the front panel can be performed through the communication ports. All measurements/tests are accessible as well.

This allows for hands free or automated operation of the device.



#### Note!

You must be familiar with communication protocols (serial ports) and how to use them in general. We only provide general information. You must code your automatic scripts on your own; we do not provide support.

### 9.2.1 Setting up the Physical Connection

The device has two USB ports (⇒ 5) that can be used to connect to a PC. The connection must be made using the optional accessory “Communications cable, USB null modem” (20-41360). This cable allows the PC to see the connection to the device as a serial port.

### 9.2.2 Port Information

To determine the serial port number, refer to the usual tools of your PC, e.g. the device manager

The serial port is configured as 115,200 baud rate, 8 data Bits, 1 stop bit, and no parity.

### 9.2.3 Command Syntax

The command description is broken into 3 columns: the keyword, the parameter form, and comments.

#### Keyword

The keyword column provides the name of the command. The actual name of the command consists of one or more keywords since SCPI commands are based on a hierarchical structure, also known as a tree system.

In such a system, associated commands are grouped together under a common node in the hierarchy, analogous to the way leaves at a same level are connected at a common branch. This and similar branches are connected to fewer and thicker branches, until they meet at the root of the tree. The closer to the root, the higher a node is considered in the hierarchy. To activate a particular command, the full path to it must be specified.

This path is represented in the following tables by placing the highest node in the left-most position. Further nodes are indented one position to the right, below the parent node. The highest level node of a command is called the keyword, followed by the node, subnode, and then the value.

Not all commands require the complexity of the full command path. For example, the `status?` command doesn't have a node or subnode.

Some commands allow for reading and writing data and some commands are read-only. To indicate a read function, a question mark (?) is placed at the end of the command path.

For example, a write command to change the internal load resistance to 100 ohms would be `CONFigure:RFMeasure:LOAD:INTernal 100<cr>`, where `<cr>` indicates a carriage-return.

Another example: A `mArms` read command would be `READ:MArms?<cr>`, which would return a value of `xxx.x<cr><lf>` where `<cr>` is a carriage-return and `<lf>` is a linefeed.

Lowercase letters indicate the long-form of the command (for example, `CONFigure:RFMeasure:LOAD:INTernal?`) and can be omitted for simplification.

Uppercase letters indicate the abbreviated, or short-form, of the commands and must be included (for example, `CONF:RFM:LOAD:INT?`).



#### Note!

Commands can be entered in either upper or lowercase or a mixture of the two, uppercase and lowercase. Commands sent to the device are not case sensitive.

(Upper and lower cases are only used when documenting the commands.)

All commands sent to the unit must terminated with a carriage return `<cr>`.

#### Parameter Form

The parameter form column indicates the number and order of parameters in a command and their legal values. Parameter formats are listed in angle brackets `<>` while string parameters are simply listed.

Square brackets `[ ]` are used to enclose one or more parameters that are optional.

The vertical bar `|` can be read as "or" and is used to separate alternative parameter options.

The query form of a command is generated by appending a question mark "?" to the last keyword. However, not all commands have a query form, and some commands exist only in the query form. The comment column is used to indicate this.

#### Comments

The comments column indicates any notes and helpful information.

**Command: CONFigure**

This subsystem allows you to setup the display and operational settings for the device.

**Note!**

There are independent settings for the Measure RF Energy screen and the Measure RF Leakage screen.

Keyword	Parameter Form	Comments
CONFigure :RFMeasure :DISPlay	:SxZy nn	S = display_screen_number 1 = one parameters 2 = two parameters 3 = three parameters 4 = four parameters 5 = five parameters 6 = display all parameters Z = zone_number nn = parameter for selected zone: 0 = mV RMS 1 = mA RMS 2 = Watts RMS 3 = mV Peak 4 = mV Pk-Pk 5 = mV Pk / mV Pk-Pk 6 = mV Pk+ 7 = crest factor 8 = kHz
:SCReen	< numeric_value >	range 1–6 1–5 = number of display zones 6 = measurement list display
:LOAD	:MODE INTernal   EXTernal   INT/ EXTernal :INTernal <numeric_value> :EXTernal <numeric_value> :ACTual? Read Only, returns calibrated	0–5500 0–5500 read only; returns calibrated load value, what the 2350 uses for Watts calcula- tions
:INPut	:TYPE ISOlated   GND	
CONFigure :RFLeakage :MODE	LKG1A   LKG1B   LKG2   LKG3	
:DISPlay	:SxZy nn	S = display_screen_number 1 = one parameters 2 = two parameters 3 = three parameters 4 = four parameters 5 = five parameters 6 = display all parameters Z = zone_number nn = Parameter for selected zone: 0 = mV RMS 1 = mA RMS 2 = Watts RMS 3 = mV Peak 4 = mV Pk-Pk 5 = mV Pk / mV Pk-Pk 6 = mV Pk+ 7 = crest factor 8 = kHz

:SCReen	< numeric_value >	range 1–6 1–5 = number of display zones 6 = measurement list display
:AVERaging	FAST   SLOW   MEDium	
:LOAD	:MODE INTernal   EXTernal   INT/ EXTernal :INTernal <numeric_value> :EXTernal <numeric_value> :TOTal?	0–5500 0–5500 read only; returns combined load based on internal
CONFigure :CQM		
:LOAD	OPEN or <numeric_value>	open circuit or 0–500 Ω
:COHMs	<numeric_value>  :UP  :DOWN	Range 0–500, sets the amount to change the CQM resistance when the ohms up/down buttons are used. Same as tapping change by ohms up button. Same as tapping change by ohms down button.
:POHMs	<numeric_value>  :UP  :DOWN	Range 0–500, sets the amount to change the CQM resistance when the ohms up/down buttons are used. Same as tapping change by percent up button. Same as tapping change by percent down button.
:HOLD	ON   OFF	
:MODE	MAIN   RFMeasure   RFLeakage   CQM   LCUrve   ASEquence   SYStools	

**Command: SYSTem**

This subsystem allows you to setup the startup mode for the unit, as well as directly control the unit, as if tapping the keys on the front panel.

Keyword	Parameter Form	Comments	
SYSTem		read Only	
:VERsion?			
:VOLume		range 0–10	
:AVERaging	:FAST :MEDium :SLOW :WINdow	<numeric_value> <numeric_value> <numeric_value> <numeric_value>	range 1–200 (samples) range 1–200 (samples) range 1–200 (samples) range 0.0–100.0 (mV)



**Command: READ**

This subsystem allows you to get measurements from the device.

Keyword	Parameter Form	Comments
READ:	MVrms   MArms   WArms   MVPeak   MVPP   CF   KHZ	read only
	ALL?	Returns all readings in comma delimited format.
	DATA?	read only 65535 bytes hex data, mV values in double byte format decimal point not included low range = 2DP, high range =1DP
	TEMP?	returns system temperature
	SVOLTage?	Returns comma delimited list of system supply voltages: Footswitch Fuse, +12V, Vbacklight, +5V, +3D, +3ETX, +3DISP, VPS2, front USB, bottom USB, top USB 2 x USB

**Command: STATUS**

This subsystem provides status on the operating mode of the unit including messages that would normally be seen on the display.

Keyword	Parameter Form	Comments																																																			
STATUS?	<table border="1"> <thead> <tr> <th>Bit</th> <th>Value</th> <th>Definition</th> </tr> </thead> <tbody> <tr><td>0</td><td>1</td><td>hold mode</td></tr> <tr><td>1</td><td>2</td><td></td></tr> <tr><td>2</td><td>4</td><td>calibration mode</td></tr> <tr><td>3</td><td>8</td><td></td></tr> <tr><td>4</td><td>16</td><td></td></tr> <tr><td>5</td><td>32</td><td></td></tr> <tr><td>6</td><td>64</td><td></td></tr> <tr><td>7</td><td>128</td><td></td></tr> <tr><td>8</td><td>256</td><td>error present</td></tr> <tr><td>9</td><td>512</td><td>mV out of range</td></tr> <tr><td>10</td><td>1024</td><td>mA out of range</td></tr> <tr><td>11</td><td>2048</td><td>Watts out of range</td></tr> <tr><td>12</td><td>4096</td><td>mV peak out of range</td></tr> <tr><td>13</td><td>8192</td><td>crest factor out of range</td></tr> <tr><td>14</td><td>16384</td><td>fan 1 blocked</td></tr> <tr><td>15</td><td>32768</td><td>fan 2 blocked</td></tr> </tbody> </table>	Bit	Value	Definition	0	1	hold mode	1	2		2	4	calibration mode	3	8		4	16		5	32		6	64		7	128		8	256	error present	9	512	mV out of range	10	1024	mA out of range	11	2048	Watts out of range	12	4096	mV peak out of range	13	8192	crest factor out of range	14	16384	fan 1 blocked	15	32768	fan 2 blocked	read only
Bit	Value	Definition																																																			
0	1	hold mode																																																			
1	2																																																				
2	4	calibration mode																																																			
3	8																																																				
4	16																																																				
5	32																																																				
6	64																																																				
7	128																																																				
8	256	error present																																																			
9	512	mV out of range																																																			
10	1024	mA out of range																																																			
11	2048	Watts out of range																																																			
12	4096	mV peak out of range																																																			
13	8192	crest factor out of range																																																			
14	16384	fan 1 blocked																																																			
15	32768	fan 2 blocked																																																			

**Command: Common Commands**

This subsystem provides access to common SCPI commands.

Keyword	Comments																																																			
*IDN?	read only Returns the following information: manufacturer, model, serial number, firmware version, software version, OS version																																																			
*RST	write only Resets device to default power up state.If selected, the saved profile is loaded ⇔ "Using System Profiles"  19.																																																			
*STB?	read only Returns the status byte information: <table border="1"> <thead> <tr> <th>Bit</th> <th>Value</th> <th>Definition</th> </tr> </thead> <tbody> <tr> <td>0</td> <td>1</td> <td>hold mode</td> </tr> <tr> <td>1</td> <td>2</td> <td></td> </tr> <tr> <td>2</td> <td>4</td> <td>calibration mode</td> </tr> <tr> <td>3</td> <td>8</td> <td></td> </tr> <tr> <td>4</td> <td>16</td> <td></td> </tr> <tr> <td>5</td> <td>32</td> <td></td> </tr> <tr> <td>6</td> <td>64</td> <td></td> </tr> <tr> <td>7</td> <td>128</td> <td></td> </tr> <tr> <td>8</td> <td>256</td> <td>error present</td> </tr> <tr> <td>9</td> <td>512</td> <td>mV out of range</td> </tr> <tr> <td>10</td> <td>1024</td> <td>mA out of range</td> </tr> <tr> <td>11</td> <td>2048</td> <td>Watts out of range</td> </tr> <tr> <td>12</td> <td>4096</td> <td>mV Peak out of range</td> </tr> <tr> <td>13</td> <td>8192</td> <td>crest factor out of range</td> </tr> <tr> <td>14</td> <td>16384</td> <td>fan 1 blocked</td> </tr> <tr> <td>15</td> <td>32768</td> <td>fan 2 blocked</td> </tr> </tbody> </table>	Bit	Value	Definition	0	1	hold mode	1	2		2	4	calibration mode	3	8		4	16		5	32		6	64		7	128		8	256	error present	9	512	mV out of range	10	1024	mA out of range	11	2048	Watts out of range	12	4096	mV Peak out of range	13	8192	crest factor out of range	14	16384	fan 1 blocked	15	32768	fan 2 blocked
Bit	Value	Definition																																																		
0	1	hold mode																																																		
1	2																																																			
2	4	calibration mode																																																		
3	8																																																			
4	16																																																			
5	32																																																			
6	64																																																			
7	128																																																			
8	256	error present																																																		
9	512	mV out of range																																																		
10	1024	mA out of range																																																		
11	2048	Watts out of range																																																		
12	4096	mV Peak out of range																																																		
13	8192	crest factor out of range																																																		
14	16384	fan 1 blocked																																																		
15	32768	fan 2 blocked																																																		

## Summary / Command Overview

Keywords	Nodes	Subnodes	Values		
CONFigure	RFMeasure	DISPlay	SxZy nn	x is the screen number (1–5) and y is the zone number (1–5). nn= 0–5: 0 = mV RMS 1 = mA RMS 2 = Watts RMS 3 = mV Peak 4 = mV Pk-Pk 5 = mV Pk / mV Pk-Pk 6 = mV Pk+ 7 = crest factor 8 = kHz	
			SCReen	range: 1–6 1–5 = number of display zones 6 = measurement list	
			AVERaging	FAST, SLOW, MEDium	
		LOAD	MODE	INTernal,EXTernal, INT/EXTernal	
			INTernal	0–5500 $\Omega$	
			EXTernal	0–5500 $\Omega$	
			TOTAL?	Returns combined load based on internal / external load mode	
		INPut	TYPE	ISOLated, GND	
		RFLeakage	DISPlay	SxZy nn	x is the screen number (1–5) and y is the zone number (1–5). nn = 0–5: 0 = mV RMS 1 = mA RMS 2 = Watts RMS 3 = mV Peak 4 = mV Pk-Pk 5 = mV Pk / mV Pk-Pk 6 = mV Pk+ 7 = crest factor 8 = kHz
				SCReen	range: 1–6 1–5 = number of display zones 6 = measurement list
	AVERaging			FAST, SLOW, MEDium	
	CQM		LOAD	OPEN or 0–500 $\Omega$	set or read CQM resistance
			COHMs	0–500 $\Omega$	set or read change by ohms amount
				UP	same as tapping change by ohms up button
	POHMs	0–500 (%)	set or read change by percent amount		
UP		same as tapping change by percent up button			
DOWN		same as tapping change by percent down button			
MODE	MAIN, RFMeasure, RFLeakage, CQM, Lcurve, ASEquence, SYStools				
HOLD	ON,OFF (only for RF measurement and RF leakage measurement modes)				

SYSTem	VERsion?	read only		
	VOLume	0–10		
	AVERaging	FAST	1–200 (samples)	
		MEDium	1–200 (samples)	
		SLOW	1–200 (samples)	
WINdow		0.0–100.0 (mV)		
READ	MVrms?	returns: mV RMS [read only]		
	MARms?	returns: mA RMS [read only]		
	WARms?	returns: Watts RMS [read only]		
	MVPeak?	returns: mV peak [read only]		
	MVPP?	returns: mV peak to peak [read only]		
	MVP-PP?	returns: mV peak/peak to peak [read only]		
	MVPK+?	returns: mV positive peak [read only]		
	CF?	returns: crest factor [read only]		
	KHZ?	returns: frequency [read only]		
	ALL?	returns: all readings in comma delimited format		
	DATA?	returns: entire data nuffer [read only] length = NUMSamples * 2 data format is mV in signed double byte format, decimal place is assumed based on input range (low range = 2DP, high range = 1DP)		
	TEMP?	returns system temperature (Highest temperature of 8 sensors)		
SVOLtage?	returns list of system supply voltages footswitch fuse, +12V, Vbacklight, +5V, +3D, +3ETX, +3DISP, VPS2, Front USB, side USB bot- tom, side USB top			
STATus?	Bit	Value	Definition	
	0	1	hold mode	
	1	2		
	2	4	calibration mode	
	3	8		
	4	16		
	5	32		
	6	64		
	7	128		
	8	256	error present	
	9	512	mV out of range	
	10	1024	mA out of range	
	11	2048	Watts out of range	
	12	4096	mV peak out of range	
	13	8192	crest factor out of range	
	14	16384	fan 1 blocked	
15	32768	fan 2 blocked		
*IDN?	returns the following information: manufacturer, model, serial number, firmware version, software version, OS version			
*RST	resets device to default power up state If selected, the saved profile is loaded ⇨ "Using System Profiles" 19.			
*STB?	Returns status byte information, same data format as STATus? command.			

## 10 Transport and Storage

### 10.1 Transporting the Device

Before transporting the device, unplug it and remove all connected cables (i.e. power, test leads, network and USB) and all external USB devices.

To prevent damage to the device

- transport it within the defined environmental conditions ⇨ 8
- protect the device from stress of any kind, vibration, jolts
- use adequate protection (e.g. wrapping).

Transport all cables and accessories separately; the rules given above apply as well. Transport external devices according to their instructions.

### 10.2 Storing the Device

If you are not using the device, you can store it

- within the defined environmental conditions ⇨ 8,
- using adequate protection (e.g. wrapping).

## 11 Maintenance



### Attention!

The device must be serviced only by authorized service personnel.

### 11.1 Cleaning



### Attention!

Unplug the power adapter before cleaning the surface of the device.

Clean by wiping gently with a damp, lint-free cloth. A mild detergent can be used if desired.

### 11.2 Calibration

Using your device and the stressing it is subjected to in doing so may result in deviation from the specified levels of accuracy.

We recommend a relatively short calibration interval of once per year. You can look up the calibration due date in the device ⇨ "Displaying System Information and Calibration Due Date" 19.

Calibration must be done by qualified personnel; please contact GMC-I Service GmbH ⇨ "Contact, Support and Service" 55.



### Note!

Date on the calibration certificate / Calibration interval starts upon receipt

Your device comes with a calibration certificate that has a date. It may date back some time if your device was stored a certain time before being sold.

The devices are stored according to the defined conditions. The developing drift therefore is negligible for a time period of approximately 1 year.

The characteristics of the device are thus within the specifications and you can set the first calibration interval as from receipt.

## 12 Troubleshooting



### Attention!

Troubleshooting and service procedures must only be performed by qualified technical personnel.

### 12.1 System Faults and Display Messages

The device continuously monitors for various system faults.

Message	Description	Recovery action
Left Fan Blocked	The left fan is not spinning. Permanent damage or complete failure could occur.	Check the fan for obstructions and remove obstructions. If nothing is found and the fan is not spinning contact us for service (⇒ 55).
Right Fan Blocked	The right fan is not spinning. Permanent damage or complete failure could occur.	Check the fan for obstructions and remove obstructions. If nothing is found and the fan is not spinning contact us for service (⇒ 55).
System Overtemp	The internal temperature has exceeded normal operating conditions.	Stop using the device and allow it to cool for at least a half hour. Make sure, ambient conditions are according to allowed specifications (⇒ 8). If the problem persists, contact us for service (⇒ 55).
Side USB Fuse (Front) Open	The internal fuse protecting the power supply to the side USB port towards the front of the unit has opened.	Contact us for service (⇒ 55).
Side USB Fuse (Rear) Open	The internal fuse protecting the power supply to the side USB port towards the rear of the unit has opened.	Contact us for service (⇒ 55).

If one of the faults described above occurs, you will be notified by a warning message.

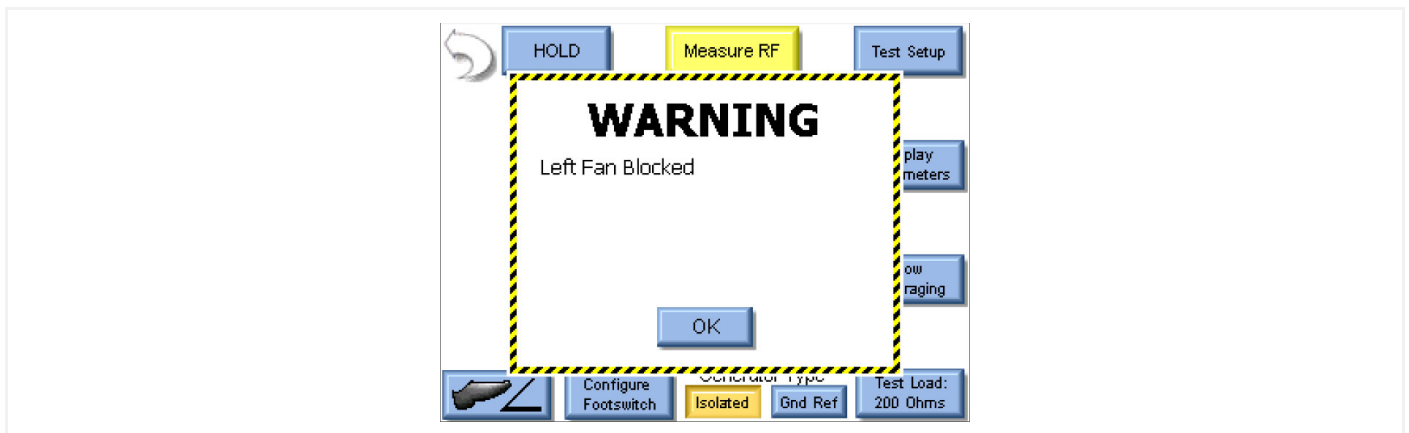

Fig. 36: Warning message example

If you tap **OK**, the warning message is cleared from the screen. The main screen will continue to display a warning sign, indicating that faults are present:

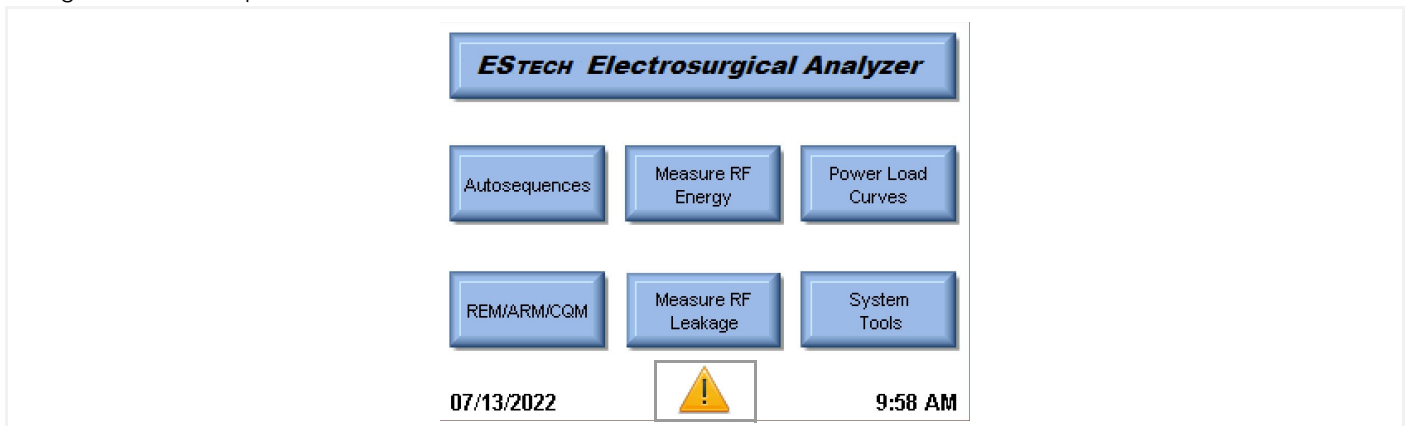

Fig. 37: Warning sign on main screen

Tapping on the warning sign will display the active faults and the status of the faults.



Fig. 38: Fault description

Once you have eliminated the cause of the fault – such as a blocked fan – tap **Reset Cleared Faults** and the fault will be removed from the list. Once all faults are cleared, the warning sign will be removed from the main screen.

## 12.2 Frequently Asked Questions

### I am trying to take a measurement/test. Why do the readings frequently bounce to zero?

Chances are you are trying to read a pulsed waveform. You cannot read pulsed waveforms with this device.

### I just want to use the device to measure current and don't need all of the other features. Is there an easy way to do this?

Yes, you can use profiles to configure the device to boot to any screen ⇒ "Choosing the Startup Screen" 18. Select your desired bootup screen – e.g. current measurement – through this feature.

### How do I enter text for the autosequence title or instructions to user?

Tap in the text box, then you can edit it ⇒ "Entering Text, Numbers and Symbols" 12.

You can also enter text via an external USB keyboard (⇒ "Using a Keyboard and Mouse" 16) or from your PC using the remote mode (⇒ 44).

### The RF measurement screen shows mA, but I need to measure watts. Can the device measure watts?

Yes, tap the mA RMS text to select the measurement to be shown. You can also tap the **Display Parameters** button to select how many measurements are shown on the screen at a time.

### Why do I have two blue REM cables?

The cable with the center pin is used to enable the dual pad function (REM) on the DUT. This cable is used for REM test mode only.

For RF Power measurements the device shorts the two dispersive inputs internally. The blue cable without the pin is used for this because it disables the REM function on the DUT.

### I am testing a force triad. When I key the DUT, I get a REM alarm on the force triad. What is happening?

You must configure the DUT for demo mode to bypass the REM alarm. Use the **Tool** icon on the right most display and select **Demo Mode** from the menu on the left most display.

### Why isn't my USB flash drive recognized by the device?

Make sure the USB flash drive is formatted as FAT32 file system. The device does not support other types formatting such as NTFS for example.

Your USB flash drive might not be compatible with the device. The devices supports most Windows compatible USB flash drives, but not all.

### Why isn't my USB keyboard / mouse recognized by the device?

Your USB input device might not be compatible with the device. The devices supports most Windows compatible USB input devices, but not all.

### The screen flickers in remote mode. How do I fix this?

The flickering may occur with certain device display setting.

1. In the CERHost utility, click **Tools**.  
The menu **Tools** menu is displayed.
  2. Click **Config**.  
The **Config** menu appears.
  3. In the **Update** area, select **Whole Screen**.
  4. Click **OK**.
- ↳ The setting is saved. The display should stop flickering.

## 13 Contact, Support and Service

You can reach Gossen Metrawatt GmbH directly and uncomplicated, we have one number for everything! Whether it's a support question, or individual desire, we answer every request at:

+49-911-8602-0	Monday–Thursday:	8:00 a.m. – 4:00 p.m.
	Friday:	8:00 a.m. – 2:00 p.m.
You can also e-mail to:	info@gossenmetrawatt.com	

Do you prefer support via e-mail?

Measuring and test instruments:	support@gossenmetrawatt.com
Industrial equipment:	support.industrie@gossenmetrawatt.com

For repairs, replacement parts, and calibrations<sup>1</sup> please contact GMC-I Service GmbH:

+49-911-817718-0	Beuthener Str. 41
service@gossenmetrawatt.com	90471 Nürnberg
www.gmci-service.com	Germany



## 14 CE Declaration

The instrument fulfills all requirements of applicable EU directives and national regulations. We confirm this with the CE mark. The CE declaration is available upon request.

A calibration certificate is included with the instrument.

A test report is included with the instrument.

1. DAkkS calibration laboratory per DIN EN ISO/IEC 17025.  
Accredited at the Deutsche Akkreditierungsstelle GmbH under registration no. D-K-15080-01-01.



## 15 Returns and Environmentally Sound Disposal

This instrument is subject to directive 2012/19/EC on Waste Electrical and Electronic Equipment (WEEE) and its German national equivalent implemented as the Waste Electrical and Electronic Equipment Act (ElektroG) on the marketing, return and environmentally sound disposal of electrical and electronic equipment. The device is a category 9 product (monitoring and control instrument) in accordance with ElektroG (German Waste Electrical and Electronic Equipment Act).



The symbol at the left indicates that this device and its electronic accessories must be disposed of in accordance with applicable legal regulations, and not together with household trash. In order to dispose of the instrument, bring it to a designated collection point or contact our product support department (⇒ 55).

This instrument is also subject to directive 2006/66/EC on batteries and accumulators and waste batteries and accumulators and its German national equivalent implemented as the Battery Act (BattG) on the marketing, return and environmentally sound disposal of batteries and accumulators.



The symbol at the left indicates that batteries and rechargeable batteries must be disposed of in accordance with applicable legal regulations. Batteries and rechargeable batteries may not be disposed of with household trash. In order to dispose of the batteries or rechargeable batteries, remove them from the instrument and bring them to a designated collection point.

Segregated disposal and recycling conserves resources and protects our health and the environment.

Current and further information is available on our website at <http://www.gossenmetrawatt.com> under the search terms "WEEE" and "environmental protection".

## 16 Appendix

### Abbreviations

AAMI	Association for the Advancement of Medical Instrumentation
Amps	Amperes
ANSI	American National Standards Institute
ARM™	Aspen Return Monitor
CF	Crest Factor
CQM	Contact Quality Monitor
DFA	Digital Fast Acquisition Technology™
DUT	Device Under Test
hrs	Hours
IEC	International Electrotechnical Commission
Pk	Peak
REM	Return Electrode Monitor
RF	Radio Frequency
RMS	Root Mean Square

---

© Gossen Metrawatt GmbH

Prepared in Germany • Subject to change, errors excepted • PDF version available on the Internet

All trademarks, registered trademarks, logos, product names, and company names are the property of their respective owners.



Gossen Metrawatt GmbH  
Südwestpark 15  
90449 Nürnberg • Germany

Phone +49 911 8602-0  
Fax +49 911 8602-669  
E-mail [info@gossenmetrawatt.com](mailto:info@gossenmetrawatt.com)  
[www.gossenmetrawatt.com](http://www.gossenmetrawatt.com)