

R6000

8-Channel Controller

3-349-163-29

10/9.22



1	Safety Precautions	3
1.1	Meanings of symbols on the instrument	3
2	Identification by Means of Serial Plate	4
2.1	Identification According to Article Number and Device Feature Code	4
2.2	Identification of Features at the Housing Front Panel	5
3	Mounting, Setup and Installation Instructions	5
3.1	Dimensional Drawing	6
4	Electrical Connection	7
4.1	Terminal Assignments	8
4.2	Auxiliary Voltage	9
4.3	Binary Inputs / Outputs (I/O)	9
4.4	Thermocouple and Pt100 Measurement Inputs (sensors 1 through 8)	10
4.5	Remote Cold Junction (CJ)	11
4.6	Additional Binary Inputs / Outputs (I/O)	12
4.7	Heating Current Monitoring (HC 1 ... 3, HV)	12
4.8	Data Interfaces	13
5	LED Functions	16
6	Initial Start-Up	17
6.1	Device Configuration	17
6.2	Device Performance after Connecting Auxiliary Voltage	17
6.3	Possible Errors	18
7	Parameters Configuration and Operation	19
8	Maintenance and Service	19
9	Characteristic Values	20
10	Repair and Replacement Parts Service, and Rental Instrument Service	24
11	Product Support Industrial Division	24

1 Safety Precautions

The R6000 controller is manufactured and tested in accordance with safety regulations IEC 61010-1 / EN 61010-1 / VDE 0411 part 1. If used for its intended purpose, safety of the user and of the device is assured.



Attention!

Check the specified nominal voltage at the front housing panel **before placing the instrument into service.**

Make sure the connector cables are not damaged, and that they are voltage-free while wiring the instrument.

If it can be assumed that safe operation is no longer possible, the device must be immediately removed from service (disconnect auxiliary voltage!). Safe operation can no longer be relied upon if the device demonstrates visible damage.

The device may not be placed back into operation until troubleshooting, repair and subsequent testing have been performed at our factory, or by one of our authorized service centers.

Work on live open instruments may only be carried out by trained personnel who are familiar with the dangers involved. Capacitors inside the device may be dangerously charged, even if it has been disconnected from all power sources.

Requirements set forth in VDE 0100 must be observed during the performance of all work.

Safety clearances to neighboring electrical circuits with dangerous voltages must be maintained during installation.

1.1 Meanings of symbols on the instrument



Warning concerning a point of danger
(Attention: observe documentation!)



Indicates CE conformity



This device may not be disposed with the trash. For further details on the WEEE marking, please refer to our website www.gossenmetrawatt.com and enter search key 'WEEE'.

2 Identification by Means of Serial Plate

The controller is identified by means of a serial plate. The serial plate is located on the left-hand side of the housing.

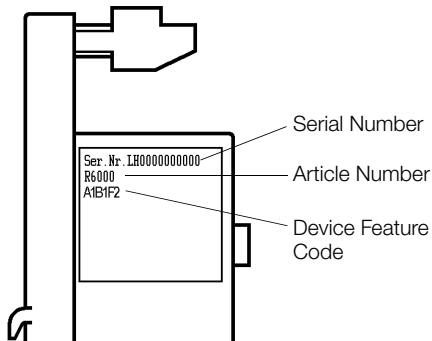

Figure 1 Serial Plate Labeling

2.1 Identification According to Article Number and Device Feature Code

Article Number / Feature	Description
R6000	8-Channel Controller
	Inputs / Outputs
A0	16 binary inputs / outputs
A1	20 binary inputs / outputs
A2	16 binary inputs / outputs, 4 continuous outputs
	Measurement Input
B1	Thermocouple, Pt100
	Connectors
D0	Screw terminal blocks
D1	Clamp-type terminal blocks
	Bus Interface
F1	CAN / CANopen
F2	Profibus DP
F3	RS 485 / Modbus protocol
F4	RS 485 / EN 60870 protocol

2.2 Identification of Features at the Housing Front Panel

4-pole connection, LED and bus terminating switch provided with feature F1, F3 or F4 (CAN or RS 485), ID field is marked accordingly

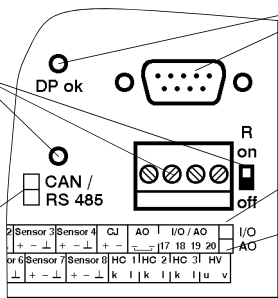

Subminiature plug and "DP OK" LED provided with feature F2 (Profibus DP)

I/O field is marked for feature A1.

AO field is marked for feature A2.

No marking for feature A0

Figure 2 Device Variant According to Included Features

3 Mounting, Setup and Installation Instructions

The R6000 is a compact 8-channel temperature controller in a top-hat rail mount housing. The controller is mounted by snapping it onto a top-hat rail in accordance with DIN EN 50022.

During installation make sure to keep safe distances to adjoining electrical circuits involving hazardous voltages.



Attention!

A sensor type must be selected for each channel with the DIP switch at the left-hand side of the housing before mounting. Unused inputs must be set to thermocouple.

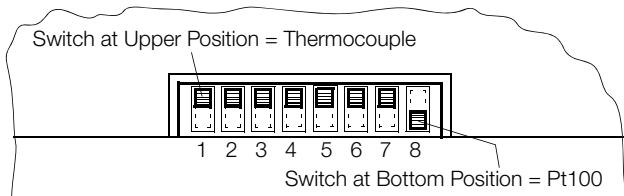

The factory default setting is always thermocouple.

Figure 3 Selecting a Sensor Type

Unobstructed air circulation must always be assured when one or several devices are installed. The ambient temperature underneath the devices may not exceed 50° C.

Aggressive vapors shorten the service life of the controller.

3.1 Dimensional Drawing

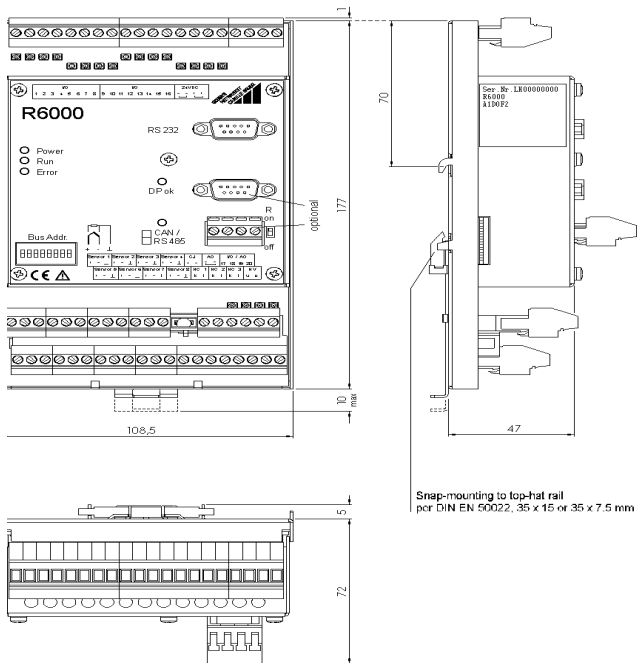

All dimensions in millimeters

Figure 4 Dimensional Drawing for Top-Hat Rail Mounting

4 Electrical Connection



Attention!

Observe terminal assignments at the housing front panel!

The instrument is not equipped with an integrated circuit breaker. Therefore, during installation, care should be taken to ensure that

- the building where the instrument is installed includes a circuit breaker,
- the circuit breaker is positioned in close proximity to the instrument and is easily accessible to the operator
- it is clearly marked as a circuit breaking device for the instrument.

Tighten screws with a manual screwdriver only!

Maximum tightening torque for all screw connections is 0.6 Nm.

Connectors: Terminal blocks for wires with cross-sections of up to 2.5 square mm, or two-core wire-end ferrules for cross-sections of up to 2 x 1.0 square mm

EN 55022 requires the following warning as regards electromagnetic compatibility:

Warning

This is a class A device. It may cause radio interference in residential environments. If this is the case, the operator may be required to implement appropriate corrective measures.

Reliable wiring is accomplished with the help of screw and clamp-type terminals which are separated according to function. Only terminal blocks of like polarity or identical color may be plugged onto the appropriate bases.

Mismatching of the terminal blocks may result in damage to the R6000 controller or interconnected components.

4.1 Terminal Assignments

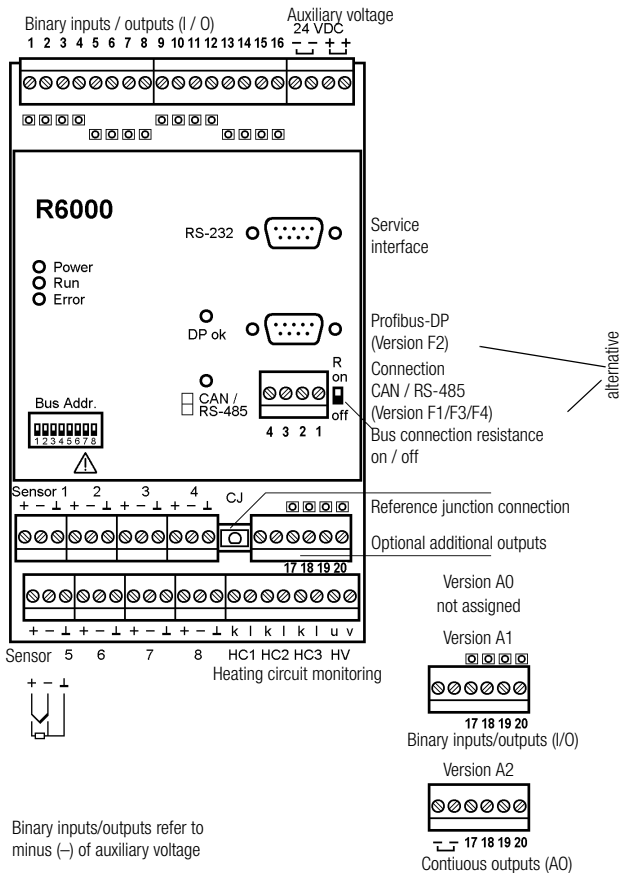

Figure 5 Positioning and Significance of the Terminals

4.2 Auxiliary Voltage

Auxiliary voltage is 24 V DC.

The two connector terminals for the negative poles are connected with one another inside the device, as is also the case for the two positive poles.

In this way, supply power can be looped through to several R6000 controllers. The terminals have a maximum current carrying capacity of 10 A (also in the event of malfunction) which may not be exceeded!

The terminal block for auxiliary voltage is black.

A completely separate safety power supply system is to be used for operation of the instrument.

4.3 Binary Inputs / Outputs (I/O)

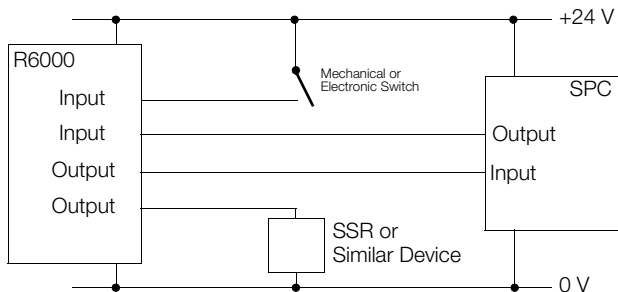

Figure 6 Schematic Diagram, Binary Inputs / Outputs

Binary I/Os which are configured as outputs connect the auxiliary voltage positive pole by means of a semiconductor switch. The load (SSR, controller input etc.) is connected to the auxiliary voltage negative pole. Three SSRs can be connected in series for controlling 3-phase heaters.

Maximum load for each individual output is 500 mA, with a limit of 3 A per controller. All outputs are safeguarded by means of integrated, self-restoring overload protection.



Attention!

After overload protection has been triggered, not only does the overload have to be eliminated, all other outputs must be de-energized as well in order to allow for self-restoration of the circuit breaker. Self-restoration may take several minutes.

If the I/Os are used as inputs, control is accomplished either by means of an active positive signal at the auxiliary voltage negative pole, or with a floating contact which switches the auxiliary voltage positive pole to the input.

The assignment of I/Os to channels and functions can be freely configured via the interface.



Attention!

Before I/Os used as inputs are configured as such, an active output signal can be read out depending upon configuration. The output of the connected device may thus be damaged as a result.

4.4 Thermocouple and Pt100 Measurement Inputs (sensors 1 through 8)

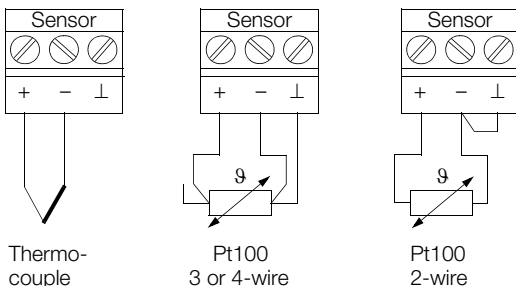

Figure 7 Sensor Terminal Assignments

Thermocouples are connected to the positive and negative terminals. No connections may be made to the \perp terminal.

If impermissible measured values should occur when using insulated thermocouples, all negative legs at the insulated thermocouples should be connected to each other. If necessary, they can be connected to the switch cabinet ground terminal.

3-wire connection is used for Pt100 sensors.

In the event of 2-wire connection, the negative terminal must be connected to the \perp terminal at the controller.

The \perp terminals are connected with each other internally.

If Pt100 sensors with 4-wire connection are used, the fourth wire may not be connected at all.

The reference junction (CJ) remains attached also for PT100 sensors.

4.5 Remote Cold Junction (CJ)

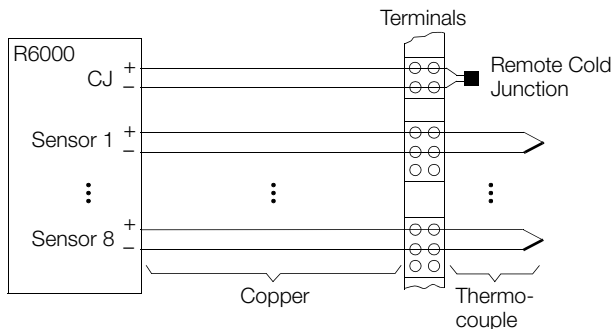

Figure 8 Schematic Diagram, Remote Cold Junction

If the thermocouple equalizing leads are not connected to the controller, the Z306A accessory (remote cold junction) is required. The remote cold junction includes a temperature sensor and a 2-pole terminal block.

The plug-on reference junction (CJ) at the R6000 is removed and is replaced with the 2-pole terminal block. The temperature sensor is attached at the transition from the thermocouple or the equalizing lead

to the copper conductor, and is connected to the 2-pole terminal block at the R6000.

The original reference junction which has now been removed from the R6000 is not used.

4.6 Additional Binary Inputs / Outputs (I/O)

Device variants including feature A1 have four additional I/Os.

All of the specifications included in chapter 4.3 on page 9 apply to these I/Os as well.

No connections may be made at the AO negative terminals at the same terminal block.

4.7 Heating Current Monitoring (HC 1 ... 3, HV)

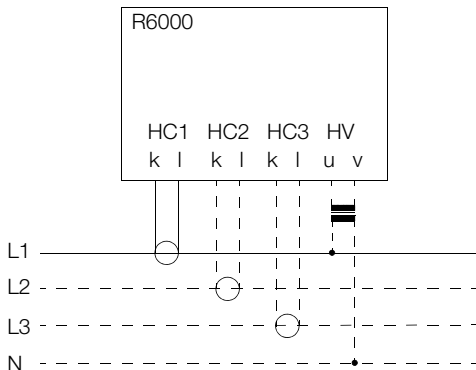

Figure 9 Schematic Diagram, Current Transformer Connection

Commercially available current transformers with max. 1 A secondary current are connected to terminals HC k and l. Compliance voltage is max. 2 V.

Three inputs are provided for monitoring 3-phase current.

Several control loops are monitored via summation current principle.



Attention!

If the terminal block is removed during operation, excessive voltage occurs at the secondary side of the current transformer.

In order to enable more accurate current monitoring, current fluctuations which result from line voltage fluctuations can be compensated. A voltage transformer with a secondary open-circuit voltage of 12 to 40 V is connected to terminals HV u and v to this end. A representative phase voltage from the heater power supply is used at the primary side. All interconnected transformers must assure safe electrical separation, and may not be connected to each other at the secondary side.

4.8 Data Interfaces

Type	Service Interface	Fieldbus Interface		
		F2	F1	F3/F4
Interface	RS 232	Profibus DP	CAN / CANOpen	RS 485
Maximum number of devices	1	32	100	32
Range of addresses	–	0 ... 126	0 ... 127	0 ... 254
Transmission speed	9.6 or 19.2 kBaud	9.6 kBaud ... 12 MBaud	10 kBaud ... 1 MBaud	9.6 or 19.2 kBaud
Protocol per	EN 60870	DIN 19245 part 3	IEC 1131 CANOpen	Modbus / EN 60870/ HB-Therm/ DIN 19244
Connection	9-pin sub-miniature plug	9-pin sub-miniature plug	4-pole screw terminal	

4.8.1 RS 232 Service Interface

9-pin sub-miniature plug connector at the controller

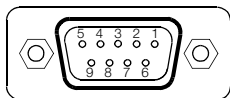

Figure 10 Diagram of Sub-miniature Plug for RS 232 Interface

Connector Pin Assignments for Sub-miniature Plug Connector for RS 232 Service Interface			Establish connection to	Connector Pin Assignments at the PC COM1 or COM2	
Pin Number	Designation	Description		Pin Number	Designation
2	TxD	Data output		2	RxD
3	RxD	Data input		3	TxD
5	GND	Signal ground		5	GND
1, 4, 6 ... 9		Not assigned			
Socket housing		Shield, connected to controller housing			

A non-crossed serial extension cable (modem cable) is required for connection to a laptop or a notebook. This can be ordered as an accessory (article no. GTZ 3241000R0001).

With the CAN bus and Profibus variants (features F1 and F2), the service interface can be used independent of bus operation.



Attention!

With RS 485 variants (features F3, F4), communication is only possible via the service interface after the 4-pole bus plug has been removed, or when the bus is not in use.

4.8.2 Bus Interfaces

The following points must be observed when wiring the bus interfaces:

- Corresponding terminals must all be connected in parallel.
- Wiring must be executed from device to device, devices may not be star-connected.
- The two bus ends should be terminated with characteristic wave impedance.
This is accomplished by setting the “R” switch at the R6000 to “on”.

CAN (variant with feature F1)

4-pole terminal block

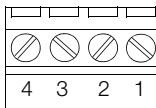

Figure 11 Diagram of Terminal Block for CAN Interface

Terminal Assignments for CAN Interface Terminal Block		
Terminal Number	Designation	Description
1	CAN-GND	Ground
2	CAN-L	Low dominant bus signal
3	CAN-SHLD	Optional shield, connected to controller housing
4	CAN-H	High dominant bus signal

Profibus DP (variant with feature F2)

9-pin sub-miniature plug connector at the controller

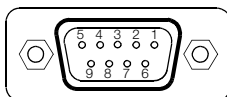

Figure 12 Diagram of Sub-miniature Plug for Profibus DP Interface

Pin Assignments for Sub-miniature Plug Connector for Profibus DP Interface		
Pin Number	Designation	Assignment / Description
1	SHIELD	Shield, connected to controller housing
3	RxD / TxD-P	Bus signal (positive open-circuit level to RxD / TxD-N)
5	DGND	Signal ground
6	VP	+5 V supply power for terminating resistor
8	RxD / TxD-N	Bus signal (negative open-circuit level to RxD / TxD-P)
2, 4, 7, 9		No connection
Socket housing		Shield, connected to controller housing

A commercially available Profibus plug can be used for connection (not included).

RS 485 (variant with feature F3 / F4)

4-pole terminal block

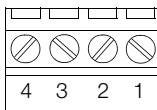

Figure 13 Diagram of Terminal Block for RS 485 Interface

Terminal Assignments for RS 485 Terminal Block		
Terminal No.	Designation	Description
1	C = DGND	Ground
2	A = RxD / TxD-P	Bus signal (positive open-circuit level to RxD / TxD-N)
3	SHIELD	Optional shield, connected to controller housing
4	B = RxD / TxD-N	Bus signal (negative open-circuit level to RxD / TxD-P)



Note

Designations A and B are not defined uniformly in various standards or for various devices. If the bus does not function, A and B may be reversed.

5 LED Functions

LEDs provide information regarding the status of the device, as well as the switching outputs and switching inputs of the controller and the fieldbus.

Status Displays

Power on	green	} LEDs on sheet metal housing
Run	green	
Active bus communication	yellow	
Error	red	
Binary input / output is active	yellow	} SMD LEDs at terminal blocks

6 Initial Start-Up

6.1 Device Configuration

- Selecting the sensor type: see “Mounting, Setup and Installation Instructions” on page 5.
- Selecting the bus address:
The bus address is selected with the DIP switch at the front panel.

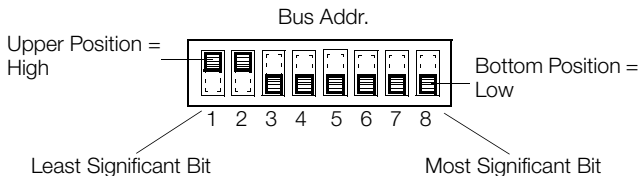

Figure 14 Example: Bus Address = 3

- All other settings are executed via the bus interface or the service interface.

6.2 Device Performance after Connecting Auxiliary Voltage

- As soon as auxiliary voltage is connected, the green “Power” LED lights up.
- Shortly thereafter, the green “Run” LED lights up, and the red “Error” LED blinks once briefly.
- The binary output LEDs then light up in accordance with control loop settings. The binary output LEDs may light up even if auxiliary voltage has not been connected, if the inputs are driven actively.
- The yellow LED for the respective bus terminal indicates active bus communication.

6.3 Possible Errors

Error	Possible Cause
Power LED does not light up.	No auxiliary voltage or reversed polarity
Run LED does not light up or blinks.	Defective processor or data error
Error LED lights up.	Defective hardware
Binary output LEDs do not light up.	Short-circuit at output or overload protection has been triggered
Binary I/O LEDs continuously illuminated	No connection between negative pole at the actuators and auxiliary voltage
Profibus LED does not light up.	No data exchange
RS 485 / CAN LED does not light up.	No transmission from R6000 e.g. due to incorrect address, bus terminator switch set incorrectly

7 Parameters Configuration and Operation

Information regarding parameters configuration and operation of the R6000 is included in the comprehensive operating instructions.

These are available from the internet at www.gossenmetrawatt.de.

Read the operating instructions completely and carefully before using the device, and follow all instructions included therein.

The operating instructions should be made available to all users.

8 Maintenance and Service

The R6000 controller does not require maintenance at regular intervals.

If the controller should nevertheless require replacement, it can be removed from the rail by pulling on the tab at the bottom of the device. This disengages the top-hat rail mount and the controller can be removed by lifting it up and forward.

Before replacement, the DIP switches at the replacement device must be configured to match those at the original device (bus address and selection of Pt100 or thermocouple).

The replacement device is attached to the top-hat rail with the mounting hooks at the rear, and is snapped into place by gently pushing down and back.

Screw or clamp-type terminal blocks can be plugged from one device to the next for quick device replacement if service is required.

9 Characteristic Values

Inputs / Outputs

Sampling rates 100 ms for each controlled variable

Thermocouple Measurement Input

Thermocouples per IEC 60584 / EN 60584 / DIN 43710

Measuring range 0 ... 50 mV

Accuracy / Error $\pm 0,3$ mV

Resolution 0.1 K

Continuous overload AC sinusoidal 50 / 60 Hz / 50 V AC
DC 1 V DC

Input impedance > 50 k Ω

Error messages for sensor breakage or polarity reversal

Reference Junction Measurement Input

Nominal input range 0 ... 70 °C

Accuracy ± 2 K

Reference junction KTY 10

P1 100 Resistance Thermometer Measurement Input

2 or 3-wire Connection

Pt100 per IEC 60751 / DIN EN 60751

Measuring range 18 ... 320 Ω

Nominal input range -200 ... 600 °C

Sensor current

Accuracy / Error < 0.5 % of measuring range span

Resolution 0.1 K

Continuous overload AC sinusoidal 50 / 60 Hz / 50 V AC
DC 1 V DC

Input impedance 13 k Ω

Cable resistance (both directions) 2-wire connection: 0 ... 30 Ω adjustable
3-wire connection: 0 ... 30 Ω compensated

Error message for sensor breakage or short circuit

Measuring Input 20 mA

Heating Current Monitoring Input

Measuring range 1 A AC (direct connection of a commercially available measuring transducer)

Resolution < 0.1 % of upper range value

Accuracy < 5 % of upper range value

Heating Voltage Input

Measuring range

10 ... 50 V AC (direct connection of a commercially available measuring transducer)

Resolution

< 0.1 % of upper range value

Accuracy

< 5 % of upper range value

Binary Inputs / Outputs

Output function

active switching outputs

supplied directly from auxiliary voltage

controlled variable output / alarm output

adjustable within a range of 0.1 ... 300 s

Function

Read-out cycle

Nominal range of use

H signal: $U \geq$ auxiliary voltage -0.5 V

$I \leq 500$ mA

total current ≤ 3 A per device

L signal: < 0.1 mA

e.g. for driving up to 3 commercially available semiconductor relays (SSR) in series

Read back output status, external control of PLC or similar

Input function

Nominal range of use

H signal: > 14 V

8 ... 16 mA at 24 V

L signal: < 7 V / < 0.2 mA

Overload limit

continuous short-circuit, interruption

H, L signal

Continuous Outputs

Output function

actuator output for proportional actuators

Output quantity

0 ... 10 V at > 1 k Ω load,

0 ... 20 mA at < 300 Ω load

Resolution

0.1 % of upper range value

Accuracy

2 % of upper range value

Status Displays

Power on

green

Run

green

Bus communication active

yellow

Error

red

Binary input / output

active

yellow

} 3 mm dia. LEDs,
at sheet metal housing

} SMD-LEDs,
at clamp-type terminal blocks

Auxiliary Voltage

A completely separate safety power supply unit is to be used for operating the controller.

Nominal value	24 V DC
Nominal range of use	18 V ... 30 V DC
Power consumption	max. 10 VA, typically 6 W (without load)

Data Interfaces

Service Interface

RS 232

Max. number of devices	1
Range of addresses	–
Transmission speed	9.6 / 19.2 kBaud
Protocol per	EN 60870
Connection	9-pin sub-miniature plug

Field Bus Interfaces

Profibus-DP

Max. number of devices	32
Range of addresses	0 ... 126
Transmission speed	9.6 kBaud ... 12 MBaud
Protocol per	EN 50170
Connection	9-pin sub-miniature plug

CAN / CANOpen

Max. number of devices	100
Range of addresses	0 ... 127
Transmission speed	10 kBaud ... 1 MBaud
Protocol per	IEC 1131 CANOpen
Connection	4-pole screw terminal

RS 485

Max. number of devices	32
Range of addresses	0 ... 254
Transmission speed	9.6 / 19.2 kBaud
Protocol per	Modbus / EN 60870
Connection	4-pole screw terminal

Bus Address Selection

The bus address is selected in binary mode with the DIP switch at the front panel.

Service Interface

A laptop or notebook can be connected to the RS 232 interface for service purposes.

Electrical Safety

Attention: The device is not equipped with an integrated circuit breaker

Design	IEC 61010-1 / EN 61010-1 / VDE 0411, part 1	
Safety class	II	
Measurement category	CAT II	
Contamination degree	2	
Protection	IEC 60529 / EN 60529 / VDE 0470, part 1	
Housing	IP 20	
PCB	IP 10	
Terminals	IP 20	

Electromagnetic Compatibility

Interference emission	IEC 61326-1 / EN 61326-1	class A
Interference immunity	IEC 61326 / A1 / EN 61326 / A1	criterion A, B

Ambient Conditions

Annual mean relative humidity, no condensation	75 %
Ambient temperature	
– Nominal range of use	0 °C ... + 50 °C
– Operating range	0 °C ... + 50 °C
– Storage range	– 25 °C ... + 70 °C

Mechanical Design

Housing	Sheet metal / plastic per UL-V0
Dimensions incl. terminal blocks (H x W x D)	max. 182 x 109 x 78 mm
Weight	approx. 0.6 kg incl. terminal blocks
Connectors	terminal blocks for wire cross sections to 2.5 mm ² or double wire-end ferrules for 2 x 1.0 mm ²
Mounting	integrated, for top-hat rails per DIN EN 50022 35 x 7.5 mm or 35 x 15 mm

10 **Repair and Replacement Parts Service, and Rental Instrument Service**

When you need service, please contact:

GMC-I Service GmbH
Service Center
Beuthener Straße 41
90471 Nürnberg • Germany
Phone +49 911 817718-0
Fax +49 911 817718-253
E-Mail service@gossenmetrawatt.com
www.gmci-service.com

This address is only valid in Germany.
Please contact our representatives or subsidiaries for service in other countries.

11 **Product Support Industrial Division**

When you need support, please contact:

Gossen Metrawatt GmbH
Product Support Hotline – Industrial Division
Phone +49 911 8602-500
Fax +49 911 8602-340
E-Mail support.industrie@gossenmetrawatt.com

© Gossen Metrawatt GmbH
Edited in Germany • Subject to change, errors excepted • PDF version available
on the Internet

All trademarks, registered trademarks, logos, product names, and company
names are the property of their respective owners.

 **GOSSEN METRAWATT**

Gossen Metrawatt GmbH
Südwestpark 15
90449 Nürnberg • Germany

Phone +49 911 8602-0
Fax +49 911 8602-669
E-Mail info@gossenmetrawatt.com
www.gossenmetrawatt.com