

METRISO PRIME 10

Insulation Resistance Tester

3-349-924-03
4/9.19



Table of Contents

1	Safety	3
2	Menu	5
2.1	Wireless Data Transmission.....	5
2.2	Measuring Parameters	5
2.2.1	Line Frequency.....	6
2.2.2	Times t1, t2 and t3 for Calculating the Absorption Coefficient	6
2.2.3	Type of Absorption Coefficient	6
2.2.4	ISO test current.....	7
2.2.5	Activation of Limit Values	7
2.2.6	Temperature Unit of Measure.....	7
2.2.7	Automatic Incrementing of the Memory Cells.....	8
2.2.8	Filter	8
2.2.9	Diagram Settings	8
2.3	Test Instrument Settings.....	9
2.3.1	LCD Contrast	9
2.3.2	Automatic Shutdown (auto-off)	9
2.3.3	Date and Time	10
2.3.4	Default Settings	10
2.3.5	Software Update.....	10
2.3.6	Key Tones.....	11
2.3.7	Wireless Connection.....	11
2.4	Languages	11
2.5	Manufacturer Information	11
3	Measurements	12
3.1	Test Instrument Diagnostics Options – Limit Values.....	12
3.2	Insulation Resistance Measurement	12
3.2.1	2-Wire Measurement	13
3.2.2	3-Wire Measurement (measurement with shielded cable).....	17
3.2.3	Measurement with the AutoISO-5000 Test Adapter (optional accessory)	19
3.2.4	Measurement with Incrementally Rising Voltage SV (stepped voltage).....	21
3.2.5	Dielectric Discharge DD	23
	Fault Localization with Pulse Control Mode	24
3.3	Resistance Measurement with Low-Voltage	26
3.3.1	Measuring Protective Conductor and Equipotential Bonding Conductor Resistance with ±200 mA Test Current	26
3.3.2	Calibrating the Measurement Cables	27
3.4	Temperature Measurement	28

4	Saving Test Results	29
4.1	Internal Memory Structure	29
4.1.1	View of the Main Screen when Storing Test Results	29
4.2	Saving Test Results to Memory.....	31
4.2.1	Entering Test Results by Overwriting	31
4.2.2	Entering Test Results by Adding	32
4.3	Viewing Saved Data	35
4.4	Deleting Saved Data.....	37
5	Data transmission	38
5.1	Accessories for Transferring Data to a PC.....	38
5.2	Data Transmission via USB.....	38
6	Test Instrument Power Supply (rechargeable battery)	39
6.1	Monitoring Battery Voltage	39
6.2	Battery Current	39
6.3	Recharging the Battery.....	39
6.4	Mains Operation	40
6.5	General Handling of Rechargeable Lithium-Ion Battery.....	40
7	Cleaning and Maintenance	40
8	Storage	41
9	Return and Environmentally Sound Disposal	41
10	Technical Data	41
10.1	Basic Data	41
10.2	Additional Data	44
10.2.1	Additional Inaccuracy per EN 61557-2 (R _{ISO}).....	44
10.2.2	Additional Inaccuracy per EN 61557-4 (R _{CONT})	44
11	Instrument Reset (default settings)	45
12	Scope of Delivery	45
12.1	Standard Accessories.....	45
13	Repair and Replacement Parts Service Calibration Center and Rental Instrument Service	45
14	Product Support	45

1 Safety

The METRISO PRIME 10 insulation tester has been developed for the detection of insulation damage and for protection against electric shock in electrical power supply networks. The measurement result are used to evaluate the safety of electrical installations. And thus the following points must be observed in order to assure flawless functioning and the accuracy of the results obtained:

- Before beginning work with the test instrument, familiarize yourself thoroughly with these operating instructions. Observe all of the manufacturer's safety requirements and technical data as well.

- Any use for other than the intended purpose in accordance with the technical specifications included in the operating instructions may result in damage to the instrument and represents a hazard for the user.
- The METRISO PRIME 10 may only be used by suitable, qualified personnel for conducting work on electrical installations. Use of the instrument by unauthorized personnel may result in damage to the instrument and represents a hazard for the user.
- During insulation resistance measurement, dangerous voltage of up to 10 kV (METRISO PRIME 10) is applied to the ends of the test leads which are connected to the test instrument.
- The device under test must be disconnected from mains power before conducting the insulation resistance measurement.
- During insulation resistance measurement, the measurement cables must not be disconnected from the device under test until measurement has been completed (**see section 3.0**). The device under test is not capacitively discharged beforehand which may result in electric shock.
- Use of these operating instructions does not eliminate the need comply with work safety, health protection and other safety regulations or fire prevention measures during testing. Before beginning work in special environments such as voltage-free systems or potentially explosive atmospheres, consult with the responsible contact persons for safety and health.
- Work under the following conditions is impermissible if:
 - ⇒ The test instrument is damaged and partially or completely inoperative
 - ⇒ The test instrument's insulation is damaged
 - ⇒ The test instrument has been stored for an excessively long period of time under conditions which do not comply with the specified requirements (e.g. extremely high atmospheric humidity). If the test instrument has been moved from a cold to a warm environment with high atmospheric humidity, no measurements may be conducted until the test instrument has warmed up and become adjusted to the ambient conditions (approx. 30 minutes).
- **BAT!** display: low battery voltage display – the battery must be recharged.
- Before testing can be started, the right measurement has to be selected and it must be assured that the measurement cables have been correspondingly connected to the test instrument.
- The test instrument may not be connected to voltage sources which deviate from those described in the operating instructions.
- The inputs of the insulation tester are protected for 60 seconds against overvoltage of up to 825 V caused by possible connection to voltage conducting objects.
- The instrument may only be repaired by authorized service partners.

Note:

Due to continuous further development of the device software, the representation of displays in the operating instructions may deviate from the displays on the instrument for some functions.

Important!

In order to ensure correct display of the battery level, the battery must be completely discharged and then fully recharged before use.

Attention:

Any attempt to install the driver in the 64 bit version of Windows 8 result in the following error message: "Installation failed".

Reason: Windows 8 inhibits the installation of drivers without a digital signature.

Solution: Deactivate the digital driver signature in Windows.

2 Menu

①



Press the **MENU** key.

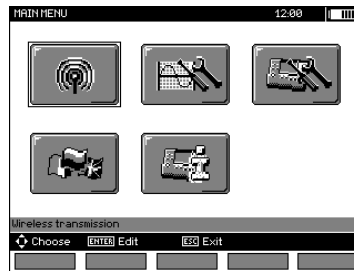

The main menu includes the following selection:

- Wireless transmission
- Settings for measurements
- Test instrument settings
- Language
- Manufacturer information

②

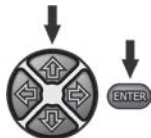

Press the **↑**, **↓** and **←**, **→** keys in order to navigate to the desired selection. Select the desired menu by pressing the **ENTER** key.

2.1 Wireless Data Transmission

See sections 5.3 through 5.5.

2.2 Measuring Parameters

①

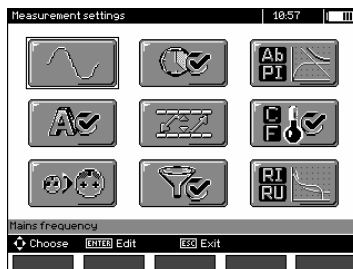

The measuring parameters menu includes:

- Line frequency
- Times t1, t2 and t3 for calculating the absorption coefficient
- Absorption coefficients Ab1, Ab2 or DAR, PI
- I_{ISO} test current
- Activation of limit values
- Temperature unit of measure
- Cell numbering
- Filter – limited R_{ISO} display
- Diagram type selection

②

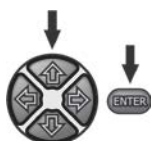

Press the **↑**, **↓** and **←**, **→** keys in order to navigate to the desired selection. Select the desired menu by pressing the **ENTER** key.

2.2.1 Line Frequency

Ideal filtering of interference is only assured if the correct line frequency is selected. The test instrument filters out interference which is generated in 50 or 60 Hz systems.

①



②

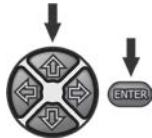

Select line frequency with the **↑** and **↓** keys. Acknowledge your selection by pressing the **ENTER** key.

2.2.2 Times t1, t2 and t3 for Calculating the Absorption Coefficient

①

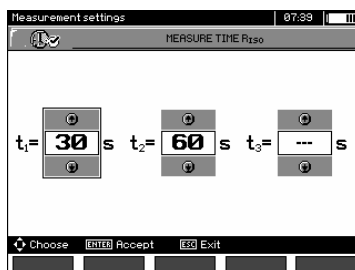

②

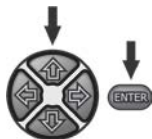

Select a time with the **←** and **→** keys. Set time with the **↑** and **↓** keys. Acknowledge your selection by pressing the **ENTER** key. Setting range: (1 s ... 600 s), t2 (1 s ... 600 s but > t1), t3 (1 s ... 600 s but > t2)

2.2.3 Type of Absorption Coefficient

①



②

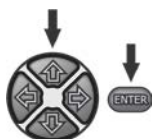

Select the coefficient (Ab, DAR, PI) with the **↑** and **↓** keys. Acknowledge your selection by pressing the **ENTER** key.

2.2.4 I_{ISO} test current

①

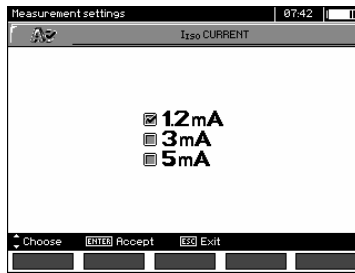

②

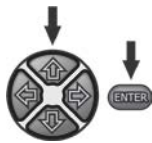

Select a test current with the **↑** and **↓** keys.
Acknowledge your selection by pressing the **ENTER** key.

2.2.5 Activation of Limit Values

①



②

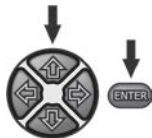

Set limit values to On or Off with the **↑** and **↓** keys.
Acknowledge your selection by pressing the **ENTER** key.

2.2.6 Temperature Unit of Measure

①

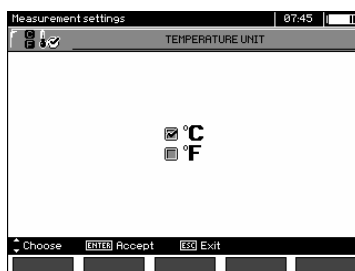

②

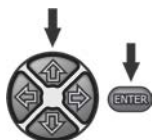

Select the temperature unit of measure with the **↑** and **↓** keys.
Acknowledge your selection by pressing the **ENTER** key.

2.2.7 Automatic Incrementing of the Memory Cells

①

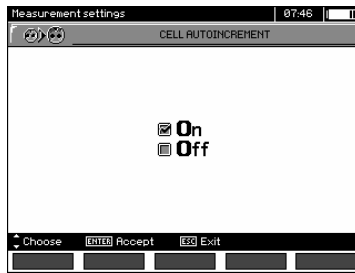

②

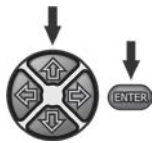

Set automatic numbering to On or Off with the **↑** and **↓** keys. Acknowledge your selection by pressing the **ENTER** key.

2.2.8 Filter

The test instrument is equipped with an extended digital filter for stabilizing measured values under difficult, unstable conditions. The test instrument displays a filtered value for the measurements from a given time period of 10, 30 or 60 seconds.

①

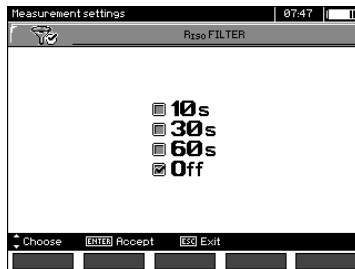

②

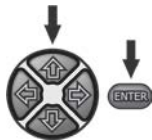

Select the time period or filter Off with the **↑** and **↓** keys. Acknowledge your selection by pressing the **ENTER** key.

2.2.9 Diagram Settings

You can select between current and resistance (I, R) or voltage and resistance (U, R) for the graphic representation of the measurement results.

①



②

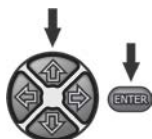

Select the display values with the **↑** and **↓** keys. Acknowledge your selection by pressing the **ENTER** key.

2.3 Test Instrument Settings

The following options can be selected:

- LCD contrast
- Automatic shutdown (auto-off)
- Date and time
- Default settings
- Software update
- Key tones
- Wireless connection

①

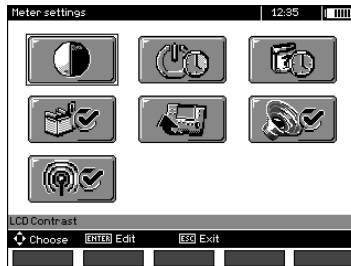

②

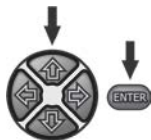

Press the **↑**, **↓** and **←**, **→** keys in order to navigate to the desired selection. Select the desired menu by pressing the **ENTER** key.

2.3.1 LCD Contrast

①

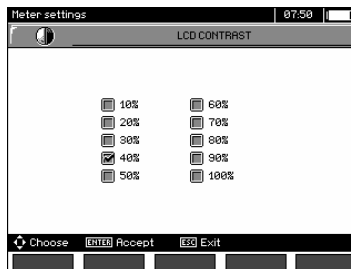

②

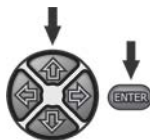

Select contrast with the **↑**, **↓** and **←**, **→** keys. Acknowledge your selection by pressing the **ENTER** key.

2.3.2 Automatic Shutdown (auto-off)

This setting specifies the duration of inactivity before the test instrument is switched off.

①

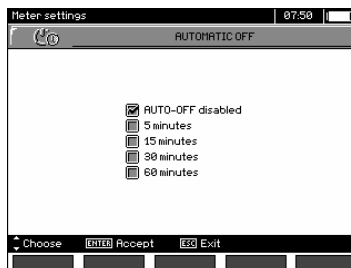

②

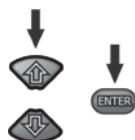

Use the **↑** and **↓** keys to select an auto-off time. Acknowledge your selection by pressing the **ENTER** key.

2.3.3 Date and Time

①

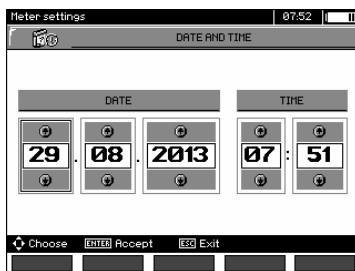

②

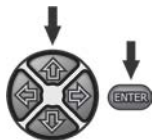

Use the ← and → keys to select day, month, year, hour or minute. Change each of these parameters with the ↑ and ↓ key. Acknowledge the selected value by pressing the **ENTER** key.

2.3.4 Default Settings

①

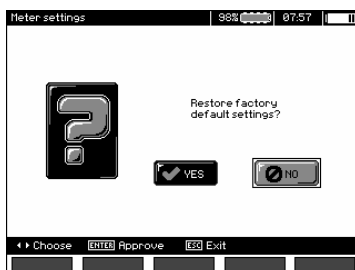

②



In order to reset the instrument to its default settings, use the ← and → keys to select **YES** and acknowledge by pressing the **ENTER** key.

2.3.5 Software Update

Caution!

Software updates should only be installed by persons with well-founded PC knowledge. Damage to the instrument due to an improperly executed software update is not covered by the guarantee.

Caution!

Fully charge the battery before updating the software. The test instrument must not be switched off and the USB connection must not be interrupted during updating.

Before updating, download the required update software from the manufacturer's website (www.gossenmetrawatt.com) and install it to your PC. Connect the PC to the test instrument. Select **Software Upgrade** in the menu and follow the instructions which appear at the display.

2.3.6 Key Tones

①

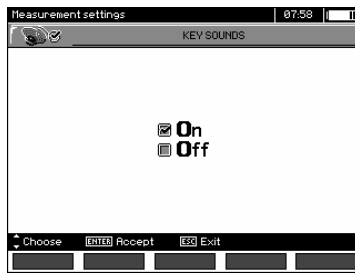

②

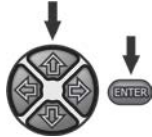

Use the **↑** and **↓** keys to switch key tones On or Off. Acknowledge your selection by pressing the **ENTER** key.

2.3.7 Wireless Connection

①



②

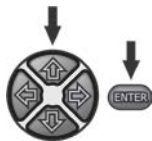

Use the **↑** and **↓** keys to switch wireless connection On or Off. Acknowledge your selection by pressing the **ENTER** key.

2.4 Languages

①



②

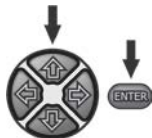

Use the **↑** and **↓** keys to select the desired language. Press the **ENTER** key to acknowledge your selection.

2.5 Manufacturer Information



3 Measurements

Notes:

The most recently obtained measurement results are stored by the measuring instrument until either the next measurement is started or another measurement is selected by turning the rotary selection switch. The most recent results are displayed for 20 seconds, after which they can be retrieved again by pressing the **ENTER** key. This is even possible after switching the test instrument off and then back on again.

Warning!
It's forbidden to change the measuring range during a measurement because the test instrument could be destroyed as a result, and it represents a hazard for the user.

3.1 Test Instrument Diagnostics Options – Limit Values

The test instrument is capable of determining whether or not the measurement results lie within the specified limit values. Maximum and minimum values can be selected as limits which should not be exceeded or fallen short of by the measurement results. Minimum values are usually selected for insulation resistance measurements, whereas maximum values are usually selected for resistance measurements at protective conductors etc.

The limit value function is activated as a default setting (see section 2.2.5). Results of the limit value function appear in the bottom left-hand corner by means of the following two icons:

- : Results are OK, the measurement lies within the limit values.
- : Results are not OK, the measurement lies outside of the limit values.

The procedure for setting limit values is described in the corresponding section. No limit values can be set in the DD, SV and pulse control operating modes.

3.2 Insulation Resistance Measurement

Warning!
The device under test must not be energized.

Note:
When measuring very large resistances, make sure that the measurement cables, probes and/or alligator clips do not touch each other. Leakage current which may result therefrom can lead to additional error in the measurement results.

The transformer's output current is limited to 1.2, 3 or 5 mA. Active current limiting is indicated by means of a continuous acoustic signal. The measurement results are correct, but voltage at the outputs is lower than previously set. Current limiting becomes active during the initial phase of the measurement due to capacitive charging of the device under test.

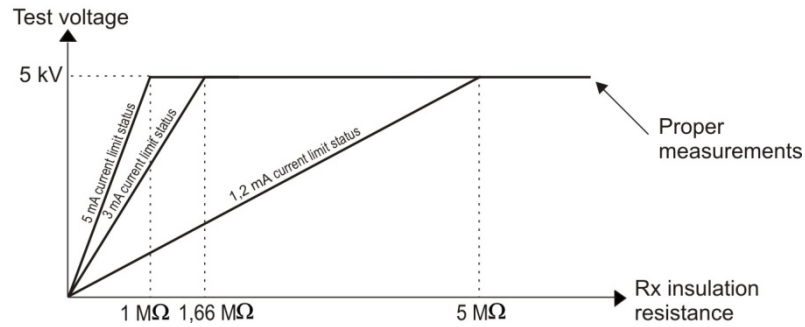
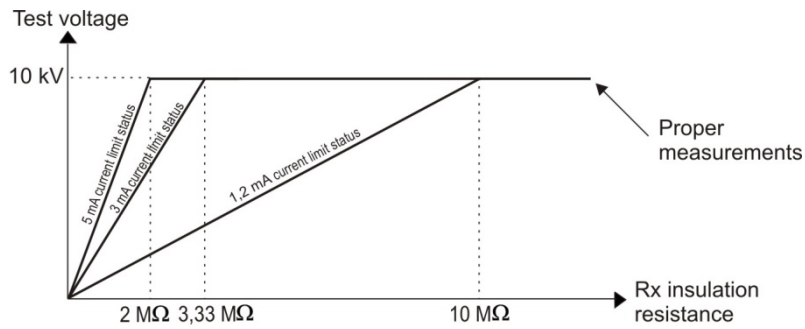

Momentary Test Voltage Displayed as a Function of Measured Insulation Resistance R_x (to nominal voltage)

3.2.1 2-Wire Measurement

①



Set the function selection switch to any desired R_{iso} position. Test voltage selection: **50 ... 10,000 V** setting.

Voltage sequence is as follows:
50 V ... 1 kV in 10 V steps,
1 kV ... 10 kV in 25 V steps.

The test instrument is in the operating mode for detecting interference voltage U_N from the device under test.

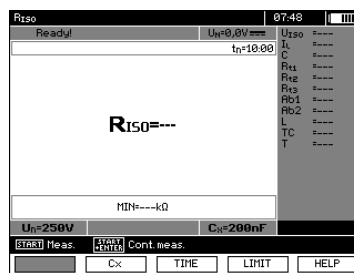

②



Press **F1** **Un** in order to change test voltage.

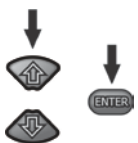

Press the **↑** and **↓** keys in order to select voltage.
Acknowledge your selection by pressing the **ENTER** key.

③



Enter test time by pressing **F3** **TIME**.

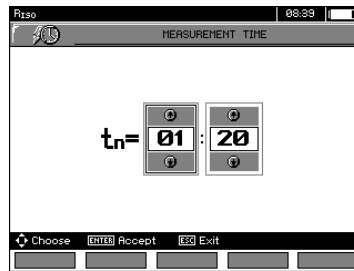

4



Press **F2** in order to enter the capacitance of the device under test [nF/km].

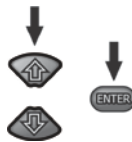
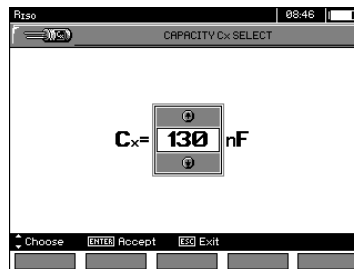

Press the **↑** and **↓** keys in order to enter the capacitance value. Acknowledge your selection by pressing the **ENTER** key. Entry range: 10 ... 990 nF. If the value is less than 10 nF or greater than 990 nF, the function for calculating cable length is deactivated.

5



Press **F4** in order to set the limit value (minimum resistance).

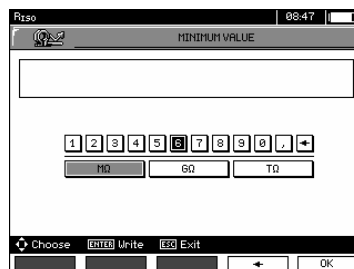

Use the **←**, **→** and **ENTER** keys to enter the resistance value.

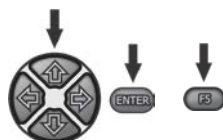
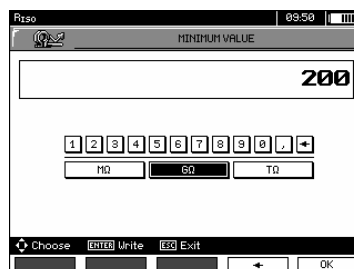

Use the **↑**, **↓**, **←**, **→** and **ENTER** keys to select the unit of measure. Acknowledge by pressing **F5** .

The limit value for R_{ISO} is the minimum value. The limit value setting range is 1 k Ω to 40 T Ω for the METRISO PRIME 10.

6

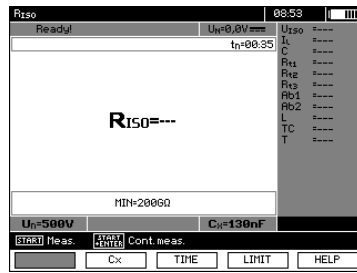

The test instrument is ready to perform a measurement. The interference voltage value can be seen at the display.

7

Connect the test leads as shown in the figure below:

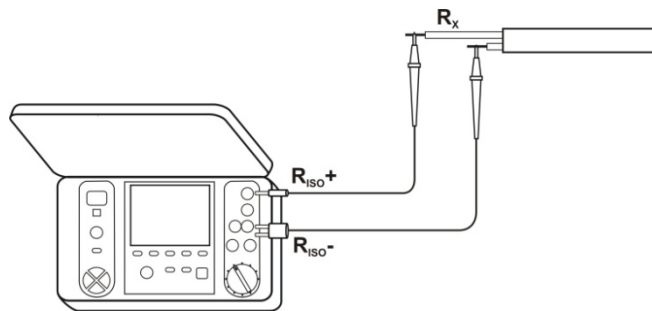

8



Pressing and holding the **START** key results in continuous measurement until the key is released or the preselected measurement time has elapsed.

9

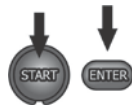

In order to perform measurement without having to continuously hold the die **START** key, press the **ENTER** key while holding the **START** key depressed, and then release both keys. In order to stop measurement in this mode, press either the **START** key once again or the **ESC** key.

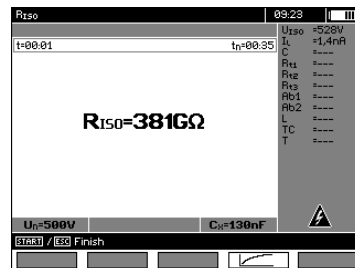



Display During Measurement

10

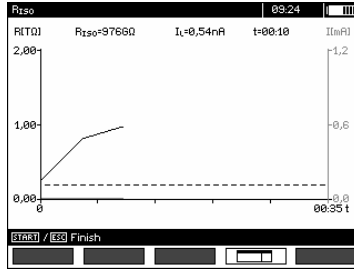

Press **F4**  in order to access a display of the measurement as a curve (diagram). Current and resistance are displayed relative to time.



The display can be returned from the graphic representation to the tabular view by pressing **F4** .

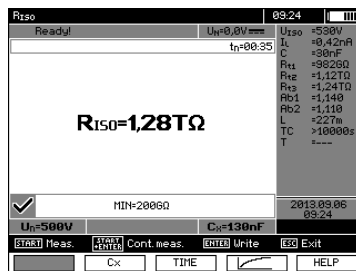

11

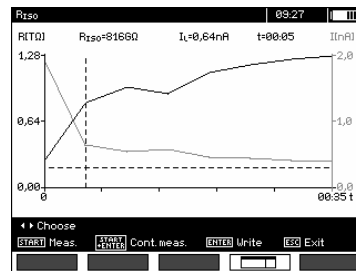

Results Displayed After Measurement

11



Graphic representation of the measurement: the dashed horizontal line indicates the selected limit value. The dashed vertical line can be moved within the diagram by pressing the  and  keys. Values for R_{ISO} , I_L and time for the line's current position appear at the upper display.

Attention:



During insulation resistance measurement, dangerous voltage of up to 10 kV (METRISO PRIME 10) is applied to the test leads. Measurements > 5,5 kV must be performed with safety gloves.



It's forbidden to disconnect the test lead from the device under test before measurement has been completed. Noncompliance with this stipulation results in electric shock with high-voltage and the device under test is not discharged.

- Deactivating t2 causes simultaneous deactivation of t3.
- Measuring time is independent of times t1, t2 and t3 as set in the menu and overwrites them. (If $t_n < t_3$, for example, measuring time is t_n .)
- The timer measurement is not started until voltage U_{ISO} has become stabilized.

- The **LIMIT I** message means that the measurement will be performed with limited power. If this state continues for more than 20 seconds, measurement is interrupted.
- If the value of one of the measured resistances is out of range, the absorption coefficient value is not displayed – horizontal dashes appear instead.
- The yellow **HV** LED lights up during measurement.
- After measurement has been completed, the capacitance of the device under test is discharged via a 200 kΩ resistor by short circuiting **R_{ISO+}** and **R_{ISO-}**. Remaining voltage at the device under test is displayed during discharging.
- In the case of insulation measurement at power cables, the conductors measured against each other must be short circuited and grounded (see figure below).
- The length of the cables is calculated on the basis of capacitance per kilometer, which is entered prior to measurement.

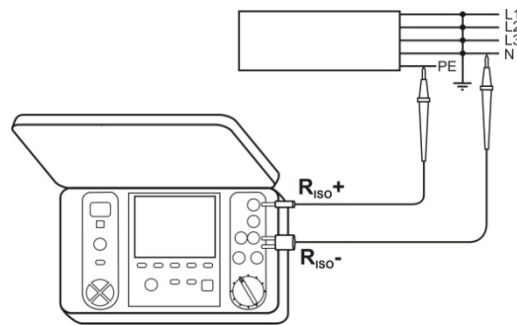

Other Information Displayed by the Test Instrument

	Test voltage is being applied to the test instrument's terminals.
NOISE!	Interference voltage of less than 50 V DC or 500 V AC at the device under test – measurement is possible but will be distorted due to additional inaccuracy.
U > 50 V + 2-tone signal	The device under test is energized. Measurement is disabled.
LIMIT I	Current limiting is active. The symbol is accompanied by a continuous acoustic signal.
HILE !	Leakage current is too high (puncturing of the insulation during measurement).

3.2.2 3-Wire Measurement (measurement with shielded cable)

The 3-wire measurement is used in order to avoid the influence of surface resistances in transformers or cables etc. Do not connect current measuring conductor **R_{ISO-}** to large earth connections or busbars. Measurement connection examples:

- When measuring resistance between windings at transformers, the test instrument's **G** socket should be connected to the transformer housing.

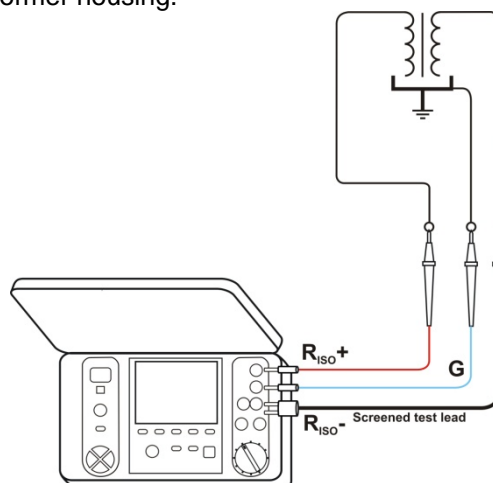

- When measuring insulation resistance between one of the windings and the transformer housing, connect the test instrument's **G** socket to the second winding.

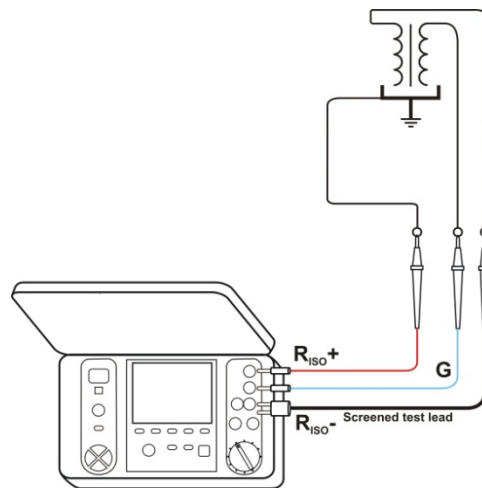

- When conducting insulation resistance measurement on cables between one of the conductors and the jacket, the surface resistance effect (important in the case of difficult climatic conditions) is eliminated by wrapping a piece of metal foil around the insulation to be tested and connecting it to the **G** socket.

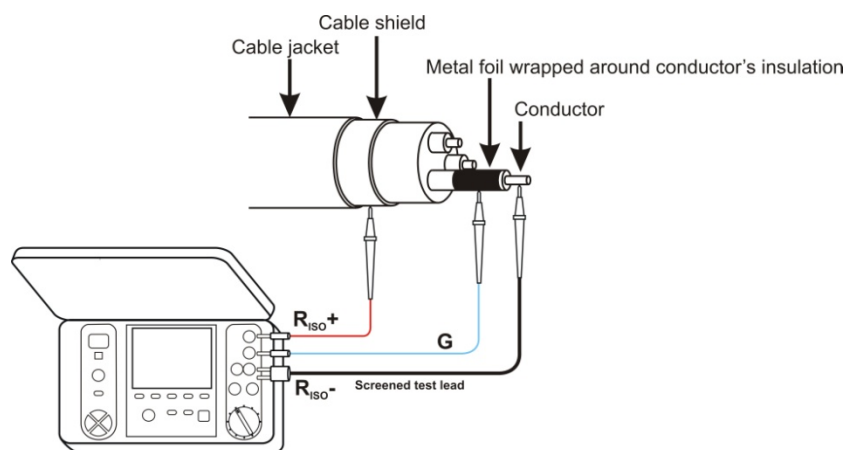

The same principle should be used when conducting resistance measurements between conductors in a cable. If it is the case the **G** terminal should be connected to the conductor which is not included in the measurement.

- In the case of insulation resistance measurements at high voltage switches, the test instrument's **G** socket should be connected to the switch's terminal insulators.

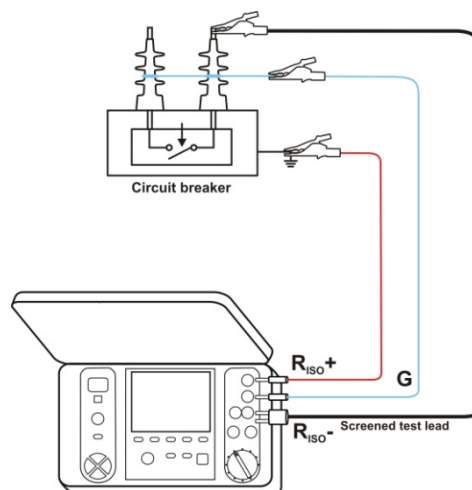

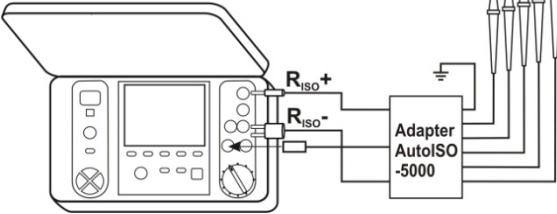

3.2.3 Measurement with the AutoISO-5000 Test Adapter (optional accessory)

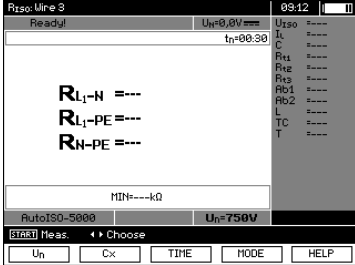
①  AutoISO-5000 test adapter connection. The test instrument automatically detects the adapter and changes the display correspondingly.

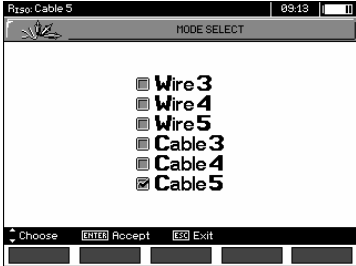
②  Use keys **F1** **Un**, **F2** **Cx** and **F3** **TIME** to select the desired voltage, capacitance and test time for the device under test. The measuring procedure is similar to the one described above in section 3.2.2.

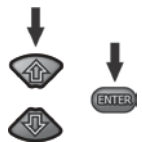
③  Open the menu for the corresponding cable type (3, 4 or 5 wire) by pressing **F4** **MODE**.

 Use the **↑** and **↓** keys to select the corresponding cable type. Acknowledge your selection by pressing the **ENTER** key.

④  Use the **←** and **→** keys to open the second menu for additional settings.

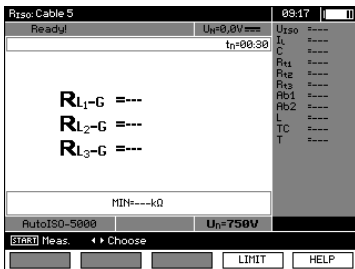
⑤  Press **F4** **LIMIT** in order to specify the minimum resistance value. This applies to all of the cable's conductor pairs.

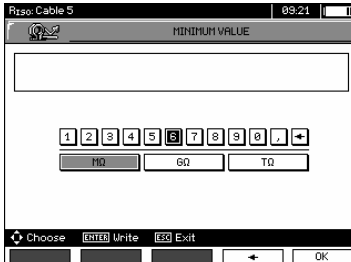

6

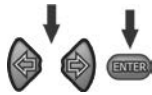

Use the \leftarrow , \rightarrow and **ENTER** keys to enter the resistance value.

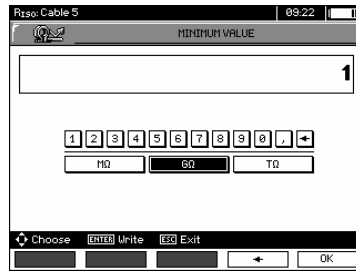

7

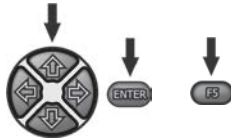

Use the \leftarrow , \rightarrow , \uparrow , \downarrow and **ENTER** keys in order to select the unit of measure. Acknowledge your entry by pressing **F5** **OK**.

8

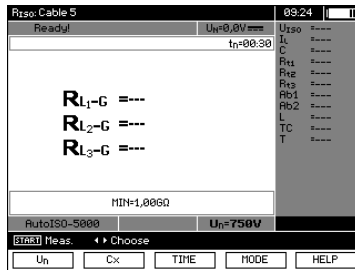

The test instrument is ready to perform a measurement. The interference voltage value can be seen at the display.

Measurement

9

Connecting the AutoISO-5000 test adapted to the cable under test:

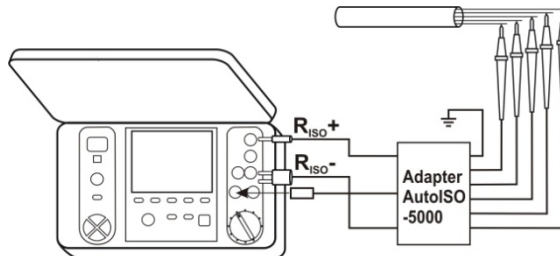

10



Press the **START** key to start the measurement. Voltage between the individual conductor pairs is tested first of all.

If any of the voltages exceed the permissible maximum value, the "!" symbol appears for the respective voltage (e.g. $U_{N-PE!}$) and measurement is aborted.

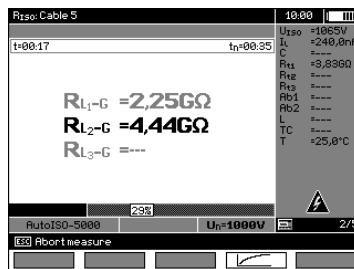

View of the Display During Measurement

11

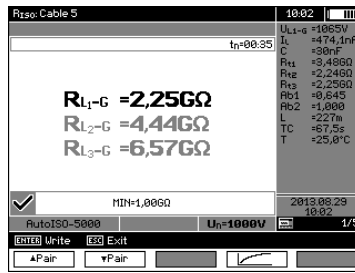

Results Displayed After Measurement

12

↓
 F1 **▲Pair** and F2 **▼Pair** can be used to switch back and forth between the groups of results.

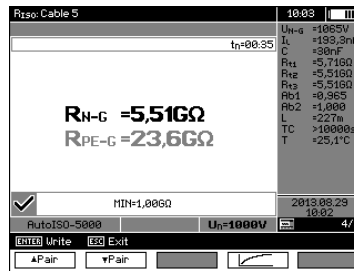

Attention:

- The comments and notes included in section 3.2.3 apply here as well.

3.2.4 Measurement with Incrementally Rising Voltage SV (stepped voltage)

In this operating mode, the test instrument conducts a series of 5 measurements with rising voltage. Voltage is increased relative to the selected maximum voltage:

- 1 kV: 200 V, 400 V, 600 V, 800 V and 1000 V
- 2.5 kV: 500 V, 1 kV, 1.5 kV, 2 kV and 2.5 kV
- 5 kV: 1 kV, 2 kV, 3 kV, 4 kV and 5 kV
- 10kV (for METRISO PRIME 10): 2 kV, 4 kV, 6 kV, 8 kV and 10 kV

The final results for each of the 5 measurements are saved to memory, which is indicated by means of a beep tone and an icon at the display.

1

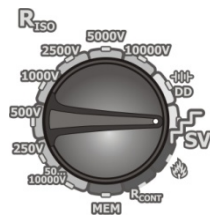

Set the function selector switch to the **SV** position. The test instrument is in the voltage measuring mode.

2

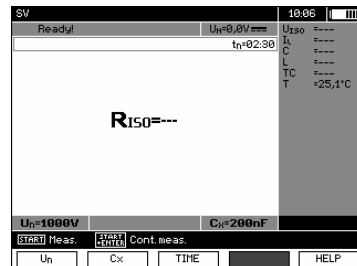

Use keys F1 **Un**, F2 **Cx** and F3 **TIME** to select the desired voltage, capacitance and test time for the device under test. The measuring procedure is similar to the one described above in section 3.2.2.

3



Pressing and holding the **START** key results in continuous measurement until the key is released or the preselected measurement time has elapsed.

4

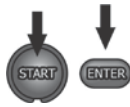

In order to perform measurement without having to continuously hold the die **START** key, press the **ENTER** key while holding the **START** key depressed, and then release both keys. In order to stop measurement in this mode, press either the **START** key once again or the **ESC** key.

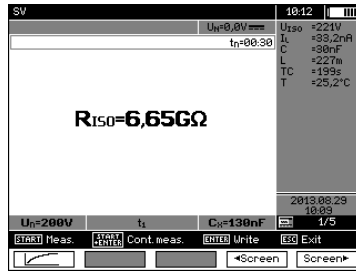

5



Results Displayed After Measurement

6



F4  and **F5**  can be used to select from amongst the consecutive measurements in the sequence of 1 to 5.

7



Press **F1**  in order to access a display of the measurement as a curve (diagram). Current and resistance are displayed relative to time.

Attention:

- Other comments and symbols displayed for this measurement are identical to those for the standard R_{ISO} measurement.
- With this function it's also possible to conduct measurement with the AutoISO-5000 adapter. The results display is similar to the display for the R_{ISO} measurement with the AutoISO-5000. The following appears at the display:

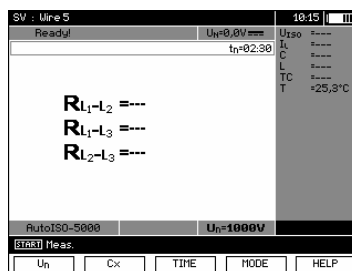

3.2.5 Dielectric Discharge DD

In the case of dielectric discharge, discharging current is measured 60 seconds after the insulation measurement has been completed. The DD value is characteristic of the quality of the insulation regardless of test voltage.

The measurement is conducted as follows: First of all, the insulation is charged with current for a previously determined period of time. If voltage does not reach the previously selected value, the device under test is not charged and the test instrument interrupts the procedure after 20 seconds. After charging and polarization have been completed, only leakage current flows through the insulation. The insulation is then discharged and dielectric discharging current begins to flow through the insulation. At first this current is the sum of dielectric discharging current (which drops off very quickly) and absorption current. Leakage current is negligible because there's no test voltage.

Current is measured 1 minute after the electrical circuit is closed. The DD value is calculated as follows

$$DD = \frac{I_{1min}}{U_{pr} \cdot C}$$

Key:

I_{1min} – measured current 1 minute after the electrical circuit is closed [nA]

U_{pr} – test voltage [V]

C – capacitance [μ F]

①

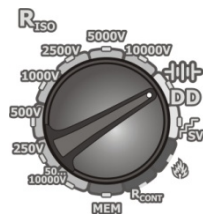

Set the function selector switch to the **DD** position. The test instrument is in the voltage measuring mode.

②

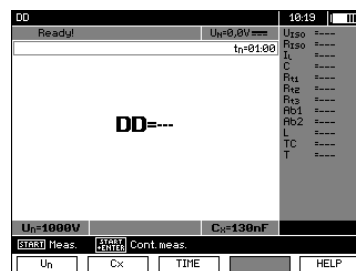

Use keys **F1** **Un**, **F2** **Cx** and **F3** **TIME** to select the desired voltage, capacitance and test time (1 to 60 min.) for the device under test. The measuring procedure is similar to the one described above in section 3.2.2.

③

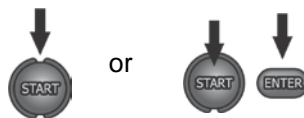

Start measurement (see section 3.2.4).

④



Both during and after measurement, the display can be switched back and forth between the results and the diagram by pressing **F4** .

5



Results Displayed After Measurement

6



Switch to display of the measurement as a curve (diagram) by pressing **F4**. Current and resistance are displayed relative to time.

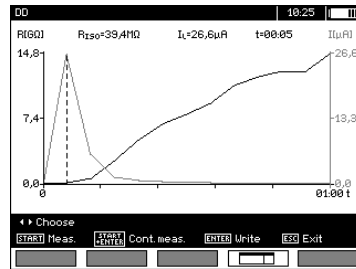

The cursor (i.e. the dashed vertical line) can be shifted with the **←** and **→** keys. The current cursor position shows the value measured at the respective point in time. The measurement results provide information about the condition of the insulation see table below:

DD Value	Condition of the Insulation
> 7	Bad
4 ... 7	Questionable
2 ... 4	Monitor
< 2	OK

Attention:

- Measurement may be impaired by additional inaccuracy in environments with powerful interference.
- With this function it's also possible to conduct measurement with the AutoISO-5000 adapter. The results display is similar to the display for the R_{ISO} measurement with the AutoISO-5000. The following appears at the display:

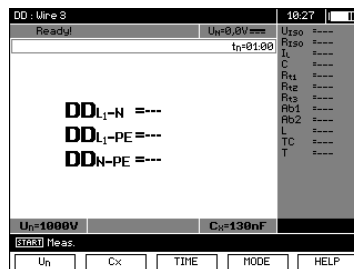

Fault Localization with Pulse Control Mode

The test instrument continues measurement of R_{ISO} until it results in puncturing of the insulation. In the case of puncturing, measurement is still continued and the fault is displayed with the puncture signal.

1



Set the function selector switch to the **DD** position. The test instrument is in the voltage measuring mode.

2

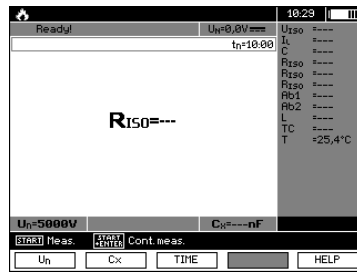

Use keys **F1** **Un**, **F2** **Cx** and **F3** **TIME** to select the desired voltage and capacitance for the device under test. The measuring procedure is similar to the one described above in section 3.2.2.

3

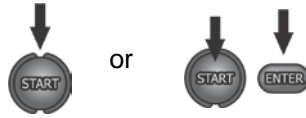

Start measurement (see section 3.2.4).

4

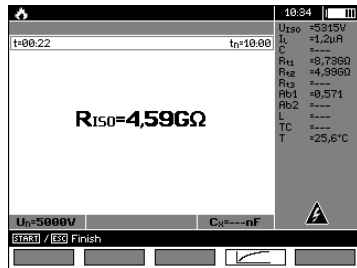

Both during and after measurement, the display can be switched back and forth between the results and the diagram by pressing **F4** .

5

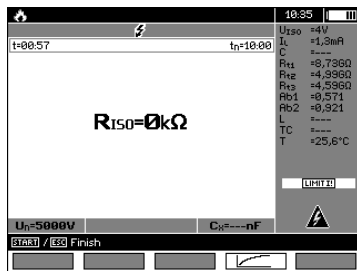

Even if puncturing occurs, the test instrument does not interrupt the measurement (as is the case with other measurements). The corresponding warning symbol appears at the top of the display.

6

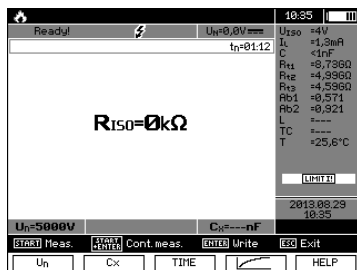

Results Displayed After Measurement when Insulation is Punctured

7



Press **F4** in order to access a display of the measurement as a curve (diagram). Current and resistance are displayed relative to time.

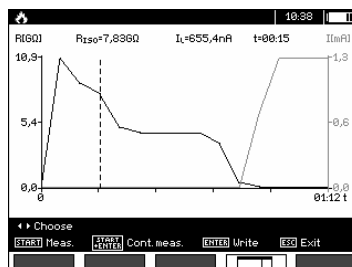

3.3 Resistance Measurement with Low-Voltage

3.3.1 Measuring Protective Conductor and Equipotential Bonding Conductor Resistance with ± 200 mA Test Current

①

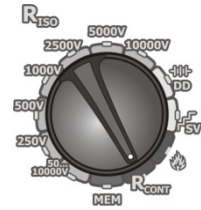

Set the function selector switch to the R_{CONT} position.

②

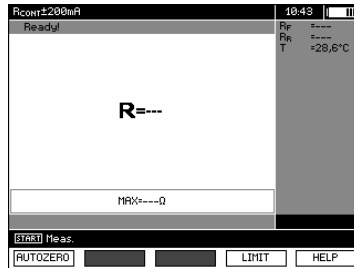

The test instrument is ready to perform a measurement. Use the **F4** **LIMIT** key in order to enter maximum resistance.

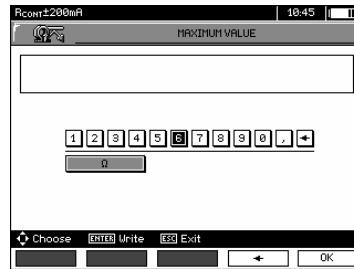

The limit values for this measurement lie within a range of 0.01 to 999 Ω . The unit of measure for the limit values is selected in the same way as for the R_{ISO} measurement.

③



Connect the test instrument to the device under test. Start the measurement by pressing the **START** key.

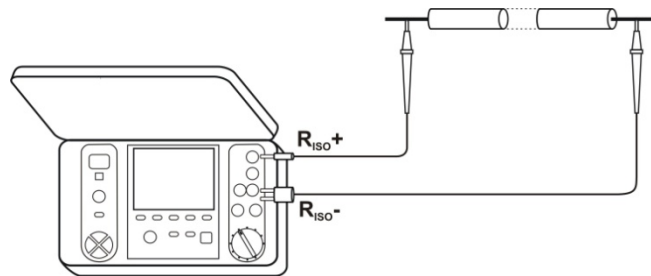

④

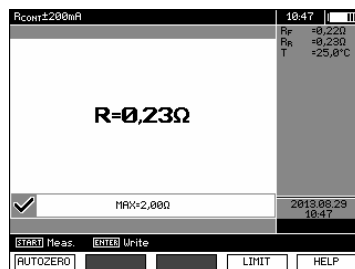

Displayed Results

Other Information Displayed by the Test Instrument

NOISE!	Interference voltage occurs at the device under test. Measurement is possible but will be distorted due to additional inaccuracy as listed in the technical data.
Voltage on object $U_n > 10$ V + 2 tones, continuous tone and LED lights up red	Interference voltage exceeds the permissible maximum value and measurement is disabled.

3.3.2 Calibrating the Measurement Cables

Compensation (zeroing) of the cables is required in order to eliminate any influence of measurement cable resistance on the measurement results.

①



Press **F1** **AUTOZERO**.



②

Follow the instructions which appear at the display.

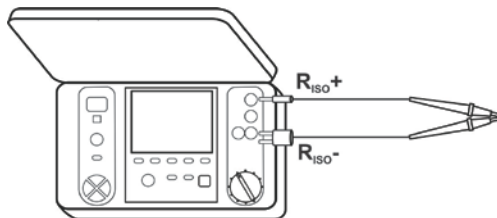

③



Press the **START** key.

④



When **AUTOZERO** appears at the display, confirm that calibration of the measurement cables has been conducted. The test instrument is then switched to the measuring mode. **AUTOZERO** continues to appear at the display during measurement. Cable compensation remains active even after switching the test instrument off and then back on again.

⑤

Follow the above described procedure without short circuiting the cable ends in order to undo calibration (return to pre-set calibration).

3.4 Temperature Measurement

Temperature measurement begins in all measuring modes as soon as the temperature probe has been connected. Measured temperature appears at the display. "T=---" appears at the display as soon as the temperature probe has been removed. The measured temperature value is refreshed once per second.

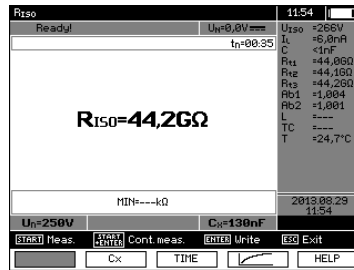

4 Saving Test Results

4.1 Internal Memory Structure

Internal memory for measurement results is set up with a tree structure (see figure below). The user can store data for 10 clients. 999 objects can be entered for each client. 999 devices under test can be entered for each object at 3 levels. 999 measurements can be saved for each object and sub-object. The overall structure is limited by internal memory capacity. 10 complete data records can be recorded to memory for a client simultaneously: 10,000 measuring points and 10,000 measuring point names, 999 object names, 999 sub-object descriptions. The memory module also has room for 99 names (selection list).

4.1.1 View of the Main Screen when Storing Test Results

Display of the Main Memory Folder

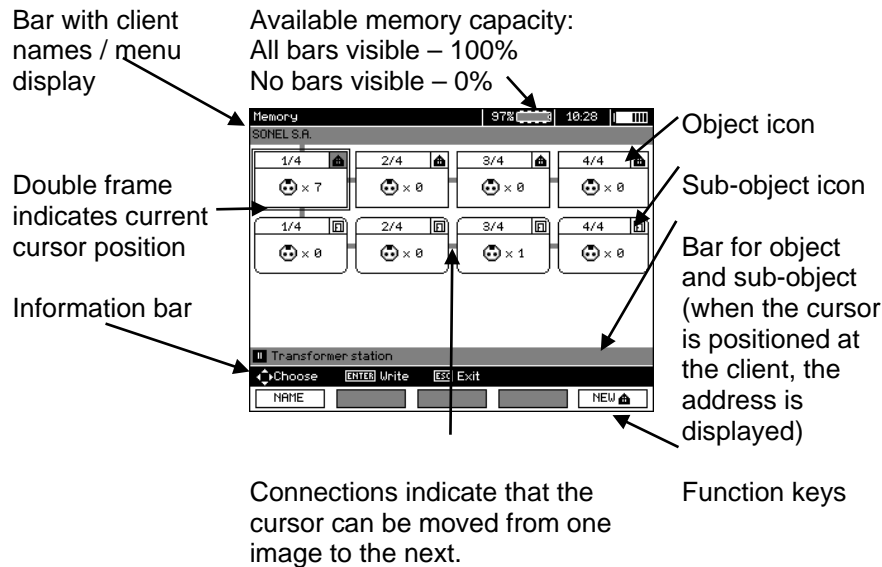

Object Entered Without Sub-Object

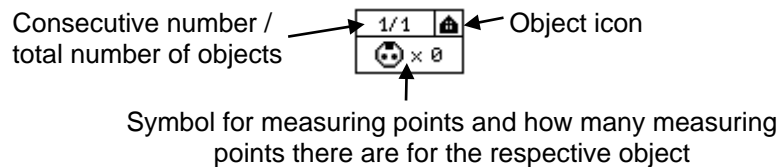

Object with at Least One Sub-Object

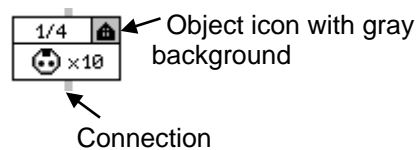

Sub-Object Without Additional Sub-Objects

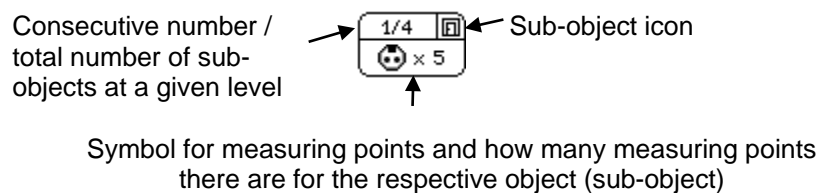

Sub-Object With Additional Sub-Objects

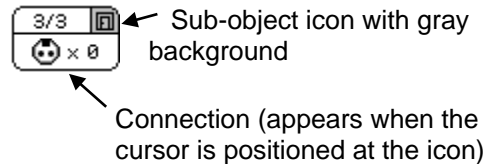

Window for Editing Client Data

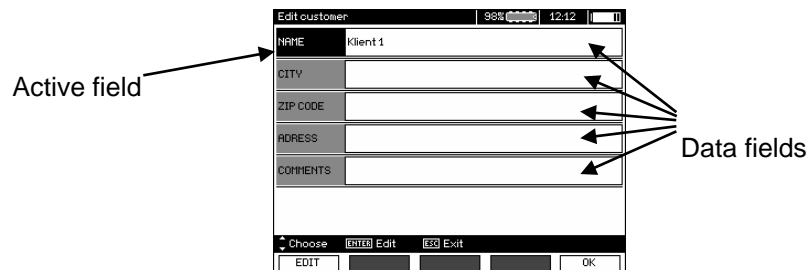

Window for Entering a Name

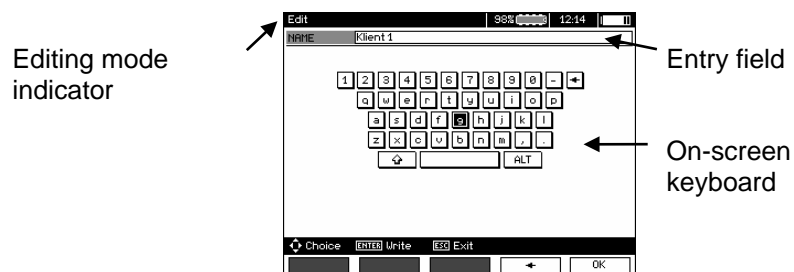

Move the cursor to shift and acknowledge with ENTER in order to enter uppercase letters. Move the cursor to ALT and acknowledge with ENTER in order to enter special characters.

Window for Entering Measurement Results

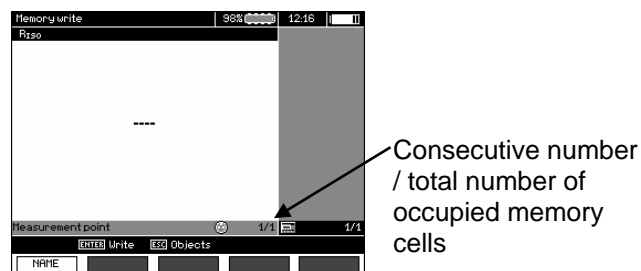

Note:

- Measurement results for all types of measurements can be saved to memory.
- Only the results of measurements triggered with the **START** key can be saved to memory (exception: AUTO zeroing for resistance measurement).
- All results (main and sub-results) of the corresponding measurements, pre-settings for measurements and date with time of executed measurements are saved to memory.
- Unsaved values in cells are no longer available later on.
- It's advisable to clear the memory module in the test instrument before a new series of measurements is conducted, or after the stored values have been read out.
- Any individual cell can contain one of the following results: R_{ISO} 2(3)-pole, R_{ISO} SV or DD.
- The cell number is automatically increased after entering a measurement result.

4.2 Saving Test Results to Memory



Press the **ENTER** key after the measurement has been completed.

4.2.1 Entering Test Results by Overwriting

①



Press the **ENTER** key once again.

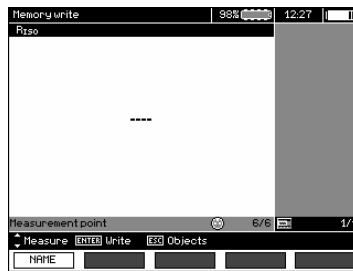

The memory cell is free for the selected measurement.



The memory cell is already reserved for the selected measurement.



Use keys **F4** **<Screen** and **F5** **Screen** to browse through the measurement's individual parameters.

②

Use the **↑** and **↓** keys in order to select a cell for a measuring point.

③

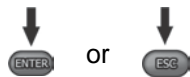

Press the **ENTER** key in order to save the results or press the **ESC** key in order to return to the view of the tree structure.

④

The following warning appears if you try to save data to an already occupied cell:

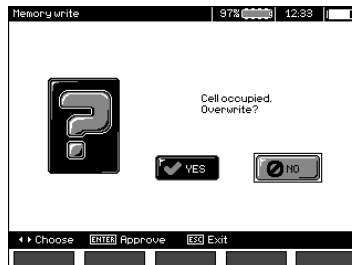

⑤

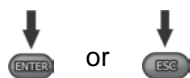

After selecting **YES**, press the **ENTER** key in order to overwrite the cell or the **ESC** key to cancel.

Note:

- The entire data record (main and sub-results), as well as the pre-settings for the measurement, are saved to memory.

4.2.2 Entering Test Results by Adding

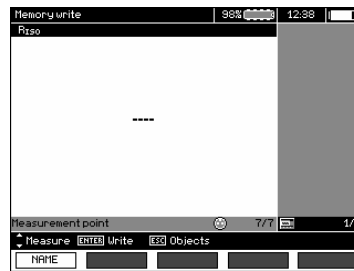

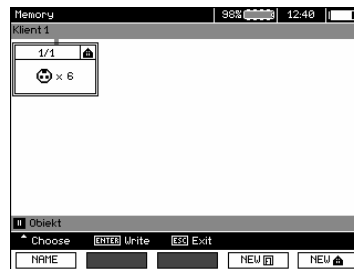

- ①  Press the **ESC** key in order to create a new object.



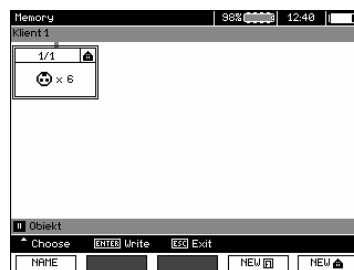

- ② Use the  key in order to move the cursor to **Client 1**.

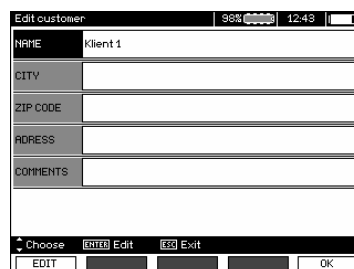

- ③ Use the  and  keys to select another client (1 to 10).

- ④ Press **F1**  in order to edit client data.



- ⑤ Use the  and  keys in order to move the cursor to the individual fields. Data can then be entered after pressing the **ENTER** key.

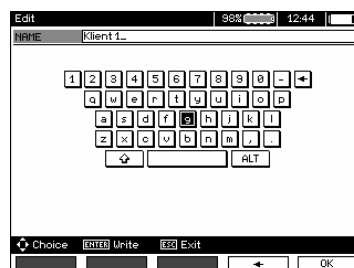

- ⑥ Use the ←, →, ↑ and ↓ keys to select any desired character. The character is then entered by pressing the **ENTER** key. Press **F4** [←] in order to delete characters. Press **F5** [OK] to accept entries and return to the display shown in step ④.

- ⑦ The following client data can be entered in this way:

- ⑧ Press **F5** [OK] to accept entries and return to the view shown in step ①.

- ⑨ Use the ↓ key in order to move the cursor to the object icon. Press **F1** [NAME] in order to edit the object name.

- ⑩ The object name is entered in the same way as client data. A selection of predefined objects can be used. After pressing **F1** [LIST], a list appears which must be previously adapted or created.

After pressing **F1** [NEW], additional object names can be added to the existing list (up to 99 terms). The terms can be deleted by pressing **F2** [DELETE].

- 11) Press **F5** in order to acknowledge the object names and add them to the view.

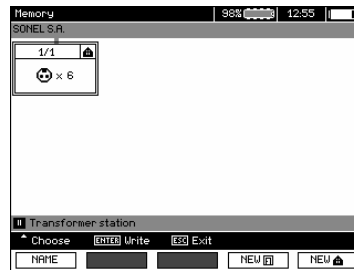

- 12) The corresponding measuring point is accessed by pressing the **ENTER** key.



- 13) Press **F1** in order to enter the measuring point designation.

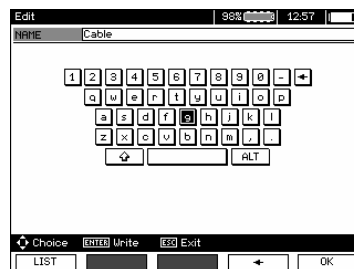

- 14) The measuring point designation is entered in the same way as for objects.

- 15) The measurement results are saved by pressing the **ENTER** key.

The structure can be supplemented as required in the main memory menu by adding new objects and sub-objects.

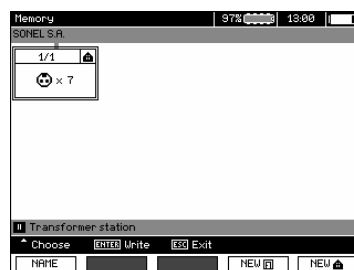

- 1 Press **F5**  to add a new object.

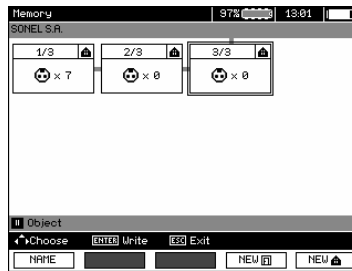

- 2 Move the cursor to the corresponding object and press **F4**  in order to add a new sub-object.

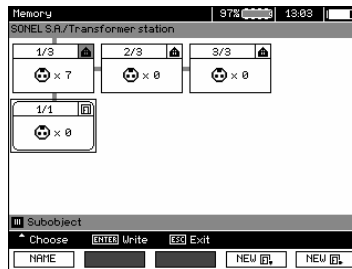

- 3 New objects and sub-objects can be added at up to 5 levels with the help of the **F4** and **F5** keys.

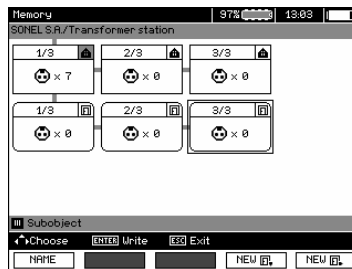

Note:

- New objects (sub-objects at a given level) are added to the right of the object at which the cursor is positioned.
- Only the sub-objects of the object at which the cursor is positioned appear at the display.
- Objects and sub-objects can only be deleted in the browse mode.
- Objects and sub-objects can be designated in the browse mode or after saving to memory following a measurement.

4.3 Viewing Saved Data

- 1

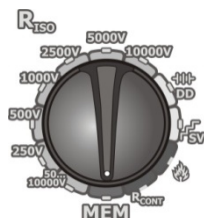

Set the function selector switch to the **MEM** position.

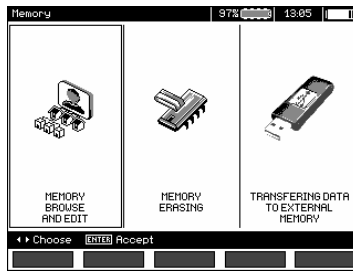

2



Use the **←** and **→** keys in order to access **MEMORY BROWSE AND EDIT**.

3



Press the **ENTER** key.

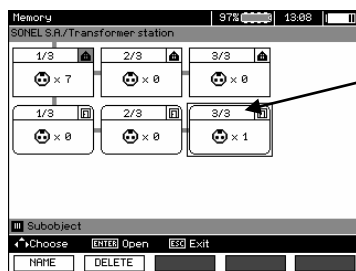

Most Recently Saved Measurement for Sub-Object 3, Level 1

4

Use the **←**, **→**, **↑** and **↓** keys in order to jump amongst the various objects and sub-objects. Press **F1** **NAME** in order to edit the designation of an object or a sub-object. Press **F2** **DELETE** in order to delete the object (sub-object) along with all of its measurement results.

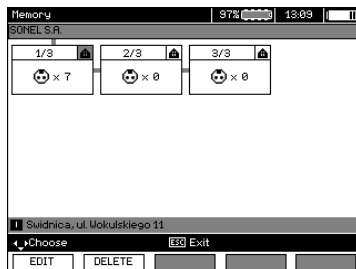

If the cursor is positioned at "Client", selection can be made with the help of the **←** and **→** keys.

5



After the desired object (sub-object) has been selected, press the **ENTER** key.

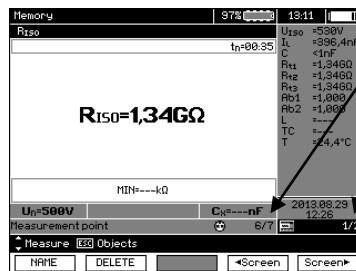

Measuring Point Number / Total Number of All Measuring Points

Measuring Type Number / Number of Measurement Types for this Measuring Point

6

Use the **↑** and **↓** keys to switch to the measuring point. Press **F1** **NAME** in order to access the editing mode for the measuring point. Press **F4** **Screen** or **F5** **Screen** in order to display all types of

results for the corresponding measuring point.
 Press **F2** **DELETE** to delete the selected measurement, or a measuring point along with all of the associated measurements:

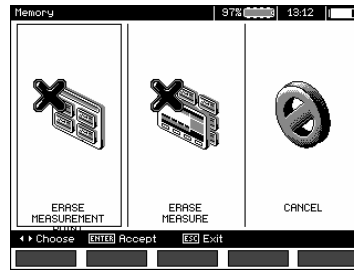

4.4 Deleting Saved Data

①

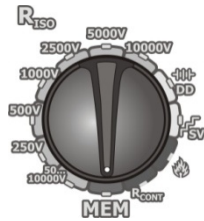

Set the function selector switch to the **MEM** position.

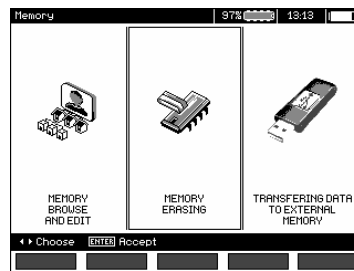

②



Use the **↑** and **↓** keys in order to select **MEMORY ERASING**.

③



Press the **ENTER** key.

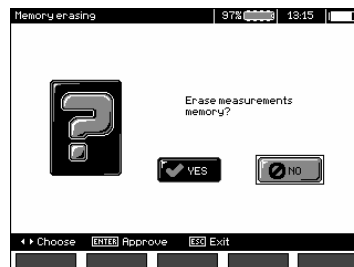

④



Use the **←** and **→** key to select **YES** or **NO**. Press the **ENTER** key to acknowledge your selection.

5 Data transmission

Note:

- Data transmission is not possible while the battery is being charged.

5.1 Accessories for Transferring Data to a PC

A USB cable is required for establishing a connection between test instrument and PC. Furthermore, a software is optionally necessary. NEXONIQ software is required to convert the data from METRISO PRIME 10, whereas IZYTRONIQ software is required for database management and report generation.

Detailed information is available from the manufacturer or your distributor.

5.2 Data Transmission via USB

①

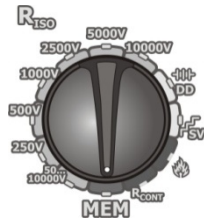

Set the function selector switch to the **MEM** position.

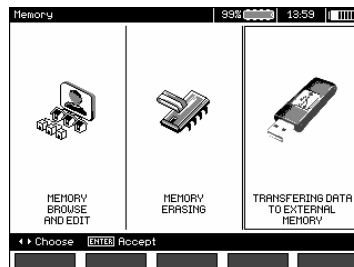

②



Use the **↑** and **↓** keys to select **TRANSFERING DATA TO EXTERNAL MEMORY**.

③



Press the **ENTER** key.

④

Connect the test instrument or a USB data storage medium to the PC.

⑤

Then start the software.

6 Test Instrument Power Supply (rechargeable battery)

6.1 Monitoring Battery Voltage

Caution!
In order to ensure correct display of the battery level, the battery must be completely discharged and then fully recharged before placing the test instrument into routine service.

The battery's charge level is indicated by a symbol in the upper right-hand corner of the display. Charge levels are indicated as follows:

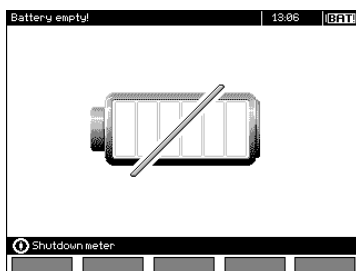
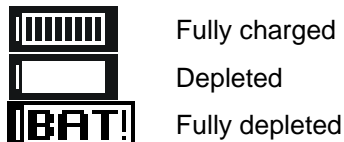

Extremely deplete – no further measurements can be performed.

6.2 Battery Current

METRISO PRIME 10 test instruments are operated with a rechargeable lithium-ion battery which can only be replaced by a certified service center.

The charger is integrated into the test instrument and only works with the rechargeable battery available from the manufacturer. The charger is operated with 230 V AC. It's also possible to operate and charge the test instrument using an automotive cigarette lighter and an external 12 V-230 V AC converter.

Caution!
Do not operate the test instrument with any voltage sources other than those specified in these operating instructions.

6.3 Recharging the Battery

Charging starts as soon as the instrument is connected to supply power, regardless of whether it's switched on or off. Charging is indicated by the battery symbol which is gradually filled with segments and a blinking green LED. The battery is charged by means of an algorithmic quick charging system which limits total charging time to roughly 7 hours. Completion of the full charging cycle is indicated by the "full" battery symbol and a continuously illuminated LED. Disconnect the instrument from mains power in order to shut it down entirely.

Note:

Mains interference may cause premature interruption of the charging process. If charging time is conspicuously short, switch the test instrument off and start the charging process again.

Other Information Displayed by the Test Instrument



Signal	Status
Green LED (once per second) and battery symbol being filled with segments blink	Charging
Continuously illuminated LED and filled battery symbol	Charging process finished
Blinking green LED (twice per second)	Error during charging process
Green LED and battery symbol blink simultaneously (twice per second) and the  symbol is displayed	Battery temperature is too high, all measuring procedures are disabled

6.4 Mains Operation

It's also possible to conduct measurements while the battery is being charged. In this case, the **ESC** key must be pressed during the charging process in order to switch to the measuring mode

The charging process is not interrupted when the test instrument is switched off by pressing the  key or by means of the auto-off function.

Other Information Displayed by the Test Instrument

Signal	Status
All of the displayed battery segments blink once per second	Charging process finished
Green LED and battery symbol blink simultaneously (twice per second) and the  and  symbols are displayed	Battery temperature is too high

6.5 General Handling of Rechargeable Lithium-Ion Battery

The test instrument is powered by a rechargeable lithium-ion battery. Consequently, it's absolutely essential to observe the following points:

- Under no circumstances may the storage temperature exceed 60 °C, which means that the test instrument must not be exposed to direct sunlight or stored in an automobile. At temperatures of above 70 °C, the rechargeable battery is rendered fully inoperative for safety reasons and must be replaced by our service department.
- The battery is switched to the protective mode as of 50 °C. In this case the test instrument can no longer be operated with the battery.
- The battery is equipped with a safety circuit which consumes minimal amounts of current. In order to prevent the battery from becoming fully depleted, the instrument should be connected to the mains for recharging at least every 5 months, and preferably at more frequent, regular intervals. In some cases it's no longer possible to recharge a fully depleted battery, in which case it must be replaced by our service department.
- The battery cannot be replaced by the customer for reasons involving safety, transport and environmental protection. If the rechargeable battery inside the instrument is defective, it must be replaced by GMC-I Service GmbH.

7 Cleaning and Maintenance

Caution!
Do not carry out any maintenance work which has not been specified by the manufacturer in these operating instructions.

Use a soft, moist cloth and all-purpose cleaner in order to clean the test instrument. Do not use any solvents or cleansers which could scratch the housing (powders, pastes etc.). Clean the probes with

water and dry them after cleaning. Lightly grease the probe before placing it into storage for any lengthy period of time.

The reels and measurement cables should be cleaned with water and cleaning agent only, and dried after cleaning.

The test instrument's electronics do not require any maintenance or cleaning.

8 Storage

The following points must be complied with if the instrument is placed into storage:

- Disconnect all measurement cables from the instrument.
- Clean the test instrument and all of its accessories.
- Roll up the measurement cables onto the reels.
- If the instrument will be placed into storage for a lengthy period of time, the rechargeable battery must be removed.
- In order to prevent full depletion of the battery during a lengthy period of storage, recharge it from time to time.

9 Return and Environmentally Sound Disposal

The instrument is a category 9 product (monitoring and control instrument) in accordance with ElektroG (German electrical and electronic device law). This device is subject to the RoHS directive. We also make reference to the fact that in this regard, the current status can be accessed on the Internet at www.gossenmetrawatt.com by entering the search term WEEE.

In accordance with WEEE 2012/19/EU and ElektroG, we identify our electrical and electronic devices with the symbol in accordance with DIN EN 50419. Devices identified with this symbol may not be disposed of with the trash. Please contact our service department regarding the return of old devices. If the rechargeable battery in your instrument is no longer usable, it must be disposed of properly in accordance with valid national regulations. The battery can only be replaced by our service department.

10 Technical Data

10.1 Basic Data

⇒ The abbreviation "rdg." used in the specifications indicates a standard measured value.

Alternating/Direct Voltage Measurement

Displayed Range	Resolution	Inaccuracy
0.0 V ... 29.9 V	0.1 V	±(2% rdg. + 20 digits)
30.0 V ... 299.9 V	0.1 V	±(2% rdg. + 6 digits)
300 V ... 750 V	1 V	±(2% rdg. + 2 digits)

- Frequency range: 45 ... 65 Hz

Insulation Resistance Measurement

Test voltage accuracy ($R_{obc} [\Omega] \geq 1000 \cdot U_N [V]$): -0, +10% of the selected value
 Measuring range per IEC 61557-2: $U_N = 10,000 \text{ V}$: 10.0 M Ω ... 40.0 T Ω

Measurement with Rising Alternating Voltage with the AutoISO-5000 ($U_{ISO} \leq 5 \text{ kV}$)

Displayed Range	Resolution	Inaccuracy
000 k Ω ... 999 k Ω	1 k Ω	$\pm (3\% \text{ rdg.} + 10 \text{ digits})$
1.00 M Ω ... 9.99 M Ω	0.01 M Ω	
10.0 M Ω ... 99.9 M Ω	0.1 M Ω	
100 M Ω ... 999 M Ω	1 M Ω	
1.00 G Ω ... 9.99 G Ω	0.01 G Ω	
10.0 G Ω ... 99.9 G Ω	0.1 G Ω	
100 G Ω ... 999 G Ω	1 G Ω	$\pm (3.5\% \text{ rdg.} + 10 \text{ digits})$
1.00 T Ω ... 9.99 T Ω	0.01 T Ω	$\pm (7.5\% \text{ rdg.} + 10 \text{ digits})$
10.0 T Ω ... 40.0 T Ω where $U_N = 10 \text{ kV}$	0.1 T Ω	$\pm (12.5\% \text{ rdg.} + 10 \text{ digits})$

Inaccuracy can be calculated for all other voltages using the following formula:

$$\delta_R = \pm(3\% + (U_{ISO} / (U_{ISO} - R_{zm} \cdot 21 \cdot 10^{-12}) - 1) 100 \%) \pm 10 \text{ digits}$$

Where:

U_{ISO} = selected test voltage [V]

R_{zm} = measured resistance [Ω]

Maximum values for measured resistance depend on the selected test voltage. See following list:

	Voltage	Measuring Range	Measuring Range for the AutoISO-5000
	50 V	200 G Ω	20.0 G Ω
	100 V	400 G Ω	40.0 G Ω
	250 V	1.00 T Ω	100 G Ω
	500 V	2.00 T Ω	200 G Ω
	1000 V	4.00 T Ω	400 G Ω
	2500 V	10.0 T Ω	400 G Ω
	5000 V	20.0 T Ω	400 G Ω
	10000 V	40.0 T Ω	

⇒ **Note:** No degree of accuracy is specified for the R_{ISOmin} measurement because the test instrument conducts this measurement with a selectable test current. This results in the following calculation:

$$R_{ISOmin} = \frac{U_{ISOnom}}{I_{ISONom}}$$

Where:

R_{ISOmin} = minimum insulation resistance measured without current limiting

U_{ISOnom} = nominal test voltage

I_{ISONom} = nominal test current (1.2, 3 or 5 mA)

- Additional inaccuracy of 3-wire measurement (caused by "G" connection): 0.05% caused by reduced leakage current via 250 k Ω resistor with measurement via 100 M Ω and test voltage of 50 V
- Max. short-circuit current: 6 mA \pm 15%
- Remaining charge at objects depends on test current: 1.2, 3, 5 mA

Measurements with AutoISO-5000

Displayed Range	Resolution	Inaccuracy
000 k Ω ... 999 k Ω	1 k Ω	±(3% rdg. + 10 digits) for the test instrument ± 1% further inaccuracy of the AutoISO-5000
1.00 M Ω ... 9.99 M Ω	0.01 M Ω	
10.0 M Ω ... 99.9 M Ω	0.1 M Ω	
100 M Ω ... 999 M Ω	1 M Ω	
1.00 G Ω ... 9.99 G Ω	0.01 G Ω	
10.0 G Ω ... 99.9 G Ω	0.1 G Ω	
100 G Ω ... to the value at which additional uncertainty of the AutoISO-5000 amounts to 5%	1 G Ω	±(3% rdg. + 10 digits) for the test instrument ± 5% further inaccuracy of the AutoISO-5000

Leakage Current Measurement

Displayed Range	Resolution	Inaccuracy
0 ... 1.2 mA	*	**
0 ... 3 mA		
0 ... 5mA		

* The measurement's resolution and electrical unit of measure result from the measuring range and the individual insulation resistance value.

** Calculation is based on the resistance measurement.

Capacitance Measurement

Displayed Range	Resolution	Inaccuracy
0 nF ... 301.01 nF	1 nF	± (5% rdg. + 5 digits)
1.00 μ F ... 49.99 μ F	0.01 μ F	

- Capacitance measurements are conducted during R_{iso} measurements (while the device under test is being discharged).
- Basic inaccuracy of the measurement corresponds to a measured capacitance value and a resistance of greater than 10 M Ω connected in parallel.
- No measuring error has been defined for measuring voltages of less than 100 V.
- Cable length L is calculated as C/C_x , and measuring inaccuracy depends on the measuring range.
- Time constant TC is calculated as $R_{iso} \times C$, and measuring inaccuracy depends on the measuring range.

Protective Conductor and Equipotential Bonding Conductor Measurements with ± 200 mA Test Current

Measuring range per IEC 61557-4: 0.12 Ω ... 999 Ω

Displayed Range	Resolution	Inaccuracy
0.00 Ω ... 19.99 Ω	0.01 Ω	±(2% rdg. + 3 digits)
20.0 Ω ... 199.9 Ω	0.1 Ω	
200 Ω ... 999 Ω	1 Ω	±(4% rdg. + 3 digits)

- Voltage with open connections: 4 V ... 24 V
- Output current where $R < 15 \Omega$: min. 200 mA (I_{sc} : 200 mA ... 250 mA)
- Measuring current flows bidirectionally, average resistance appears at the display.
- Compensation of measurement cables by means of offset balancing

Temperature Measurement

Displayed Range	Resolution	Inaccuracy
-40.0 ... 99.9 $^{\circ}$ C	0.1 $^{\circ}$ C	±(3% rdg. + 8 digits)
-40.0 ... 211.8 $^{\circ}$ F	0.1 $^{\circ}$ F	±(3% rdg. + 16 digits)

Further Technical Data

- a) Insulation class:..... Double in compliance with EN 61010-1 and IEC 61557
- b) Measuring category..... IV 600 V (III 1000 V) per EN 61010-1
- c) Housing protection per EN 60529 IP 40 (IP 67 for closed housing)
- d) Power supply Rechargeable lithium-ion battery: 14.8 V, 5.3 Ah, 78 Wh
Mains power 90 V ... 260 V, 50/60 Hz, 178 W
- e) Dimensions..... 390 x 310 x 180 mm
- f) Weight Approx. 7 kg
- g) Storage temperature range -25 °C ... +70 °C
- h) Working temperature range..... -20 °C ... +50 °C
- i) Atmospheric humidity 20% ... 80%
- j) Working altitude..... ≤ 3000 m above sea level
- k) Reference temperature +23 °C ± 2 °C
- l) Reference humidity 40% ... 60%
- m) Display..... LCD segment display
- n) Number of R_{ISO} measurements per EN 61557-2 with battery operation: min. 1000 measurements
- o) Quality standards for design, engineering and manufacturing are compliant with ISO 9001, ISO 14001 and PN-N-18001.
- p) The test instrument complies with requirements per EN 61010-1 and IEC 61557.
- q) The test instrument complies with EMC requirements (immunity in industrial environments) in accordance with EN 61326-1:2013 and EN 61326-2-2:2013

Caution!
METRISO PRIME 10 test instruments are classified as class A test instruments with regard to the evaluation of electromagnetic compatibility (EMC). Interference with and impairment of the functions of other devices must be tolerated if the test instrument is used in other environments (e.g. in residential areas).

10.2 Additional Data

The specification of additional inaccuracy is necessary primarily when the test instrument will not be used in standard environments or in metrology laboratories for calibration.

10.2.1 Additional Inaccuracy per EN 61557-2 (R_{ISO})

Important Parameter	Designation	Additional Inaccuracy
Position	E ₁	0%
Supply voltage	E ₂	1% (BAT does not light up)
Temperature: 0 °C ... 35 °C	E ₃	6%

10.2.2 Additional Inaccuracy per EN 61557-4 (R_{CONT})

Important Parameter	Designation	Additional Inaccuracy
Position	E ₁	0%
Supply voltage	E ₂	0.2% (BAT does not light up)
Temperature: 0 °C ... 35 °C	E ₃	6%

11 Instrument Reset (default settings)

- Press and hold the OFF key for a lengthy period of time in order to reset the METRISO PRIME 10 to its default settings.

12 Scope of Delivery

12.1 Standard Accessories

Standard accessories supplied by the manufacture:

- METRISO PRIME 10
- Set of measurement cables:
 - 11 kV cable, 3 m, (CAT IV 1000 V), with 4 mm safety plugs, red
 - 11 kV cable, 3 m, shielded (CAT IV 1000 V), with 4 mm safety plugs, black
 - 11 kV "E" cable, 3 m, (CAT IV 1000 V), with 4 mm safety plugs, blue
- Alligator clips, 11 kV, 32 A (CAT IV 1000 V), 3 each (black, red and blue)
- Test probes, 5.5 kV, 32 A, with 4 mm safety plugs, 2 each (red and black)
- Temperature probe (Z555J)
- USB cable
- 230 V power cable
- Accessories pouch
- Operating instructions
- Calibration certificate
- Handling instructions for lithium-ion batteries

13 Repair and Replacement Parts Service Calibration Center and Rental Instrument Service

If required please contact:

GMC-I Service GmbH
Service Center
Beuthener Straße 41
90471 Nürnberg, Germany
Phone: +49 911 817718-0
Fax: +49 911 817718-253
e-mail: service@gossenmetrawatt.com
www.gmci-service.com

This address is only valid in Germany.

Please contact our representatives or subsidiaries for service in other countries.

14 Product Support

If required please contact:

GMC-I Messtechnik GmbH
Product Support Hotline
Phone +49-911-8602-0
Fax: +49 911 8602-709
e-mail: support@gossenmetrawatt.com

Edited in Germany • Subject to change without notice • PDF version available on the Internet

 **GOSSEN METRAWATT**
GMC-I Messtechnik GmbH
Südwestpark 15
90449 Nürnberg • Germany

Phone: +49 911 8602-111
Fax: +49 911 8602-777
e-mail: info@gossenmetrawatt.com
www.gossenmetrawatt.com