

Device handbook

LINAX PQ5000-MOBILE

Operating instructions LINAX PQ5000-MOBILE (2020-07)



GMC INSTRUMENTS

Camille Bauer Metrawatt AG
Aargauerstrasse 7
CH-5610 Wohlen / Switzerland
Phone: +41 56 618 21 11
Telefax: +41 56 618 35 35
E-Mail: info@cbmag.com
<https://www.camillebauer.com>

 **CAMILLE BAUER**

Legal information

Warning notices

In this document warning notices are used, which you have to observe to ensure personal safety and to prevent damage to property. Depending on the degree of danger the following symbols are used:



If the warning notice is not followed death or severe personal injury **will** result.



If the warning notice is not followed damage to property or severe personal injury **may** result.



If the warning notice is not followed the device **may** be damaged or **may** not fulfill the expected functionality.

Qualified personnel

The product described in this document may be handled by personnel only, which is qualified for the respective task. Qualified personnel have the training and experience to identify risks and potential hazards when working with the product. Qualified personnel are also able to understand and follow the given safety and warning notices.

Intended use

The product described in this document may be used only for the application specified. The maximum electrical supply data and ambient conditions specified in the technical data section must be adhered. For the perfect and safe operation of the device proper transport and storage as well as professional assembly, installation, handling and maintenance are required.

Disclaimer of liability

The content of this document has been reviewed to ensure correctness. Nevertheless it may contain errors or inconsistencies and we cannot guarantee completeness and correctness. This is especially true for different language versions of this document. This document is regularly reviewed and updated. Necessary corrections will be included in subsequent version and are available via our webpage <https://www.camillebauer.com>.

Feedback

If you detect errors in this document or if there is necessary information missing, please inform us via e-mail to: customer-support@camillebauer.com

Contents

1. Purpose of this document	5
2. Scope of supply	6
3. Device overview	8
3.1 Short description	8
3.2 Operation and evaluation	9
3.3 Measurement data	9
3.4 Device usage	9
4. Preparation of the measurement application	10
4.1 Connecting to the measurement device	10
4.1.1 Connection via LAN interface	10
4.1.2 Connection via WLAN interface	13
4.1.3 Resetting the network settings	14
4.2 Parameterization of the device functionality	15
4.2.1 Configuration manager	15
4.2.2 Device configuration	16
4.3 Security system	18
4.3.1 RBAC management	18
4.3.2 User log in / out via website	21
4.3.3 Whitelisting clients	22
4.3.4 Secure communication using https	22
4.3.5 Audit log (SYSLOG)	23
4.4 PQ monitoring	25
4.4.1 PQ events	25
4.4.2 PQ statistic	26
4.4.3 Provision of PQ data	27
4.5 Alarming	28
4.5.1 Limit values on base quantities	28
4.5.2 Monitoring functions	29
4.5.3 Summary alarm	30
4.6 Measurement information in file format	31
4.6.1 Creating periodic file data	31
4.6.2 Periodical sending to a SFTP Server	32
5. Safety instructions	33
6. Electrical connections	35
6.1 Voltage and current inputs	35
6.2 GPS time synchronization	38
6.3 Power supply	41
7. Commissioning	42
7.1 Device start	42
7.2 Installation check	42
7.3 Measurement data reset	44
7.4 Start data recording	45
8. Evaluation of recorded data	46
8.1 Available long-term recordings	46
8.1.1 Periodic data	47
8.1.2 Events	50
8.1.3 PQ events	51
8.1.4 PQ statistic	53

8.1.5	PQ-Easy compliance report.....	55
8.2	Measurement files.....	57
8.2.1	Accessing file information via webpage.....	57
8.2.2	Evaluation of the PQDIF files.....	58
9.	Service, maintenance and disposal.....	59
9.1	Calibration and new adjustment.....	59
9.2	Cleaning.....	59
9.3	Battery.....	59
9.4	Disposal.....	59
10.	Technical data.....	60
Annex	64
A	Description of measured quantities.....	64
A1	Basic measurements.....	65
A2	Harmonic analysis.....	68
A3	System imbalance.....	69
A4	Mean values and trend.....	70
A5	Meters.....	71
B	Network settings in Windows.....	72
C	Operating instructions Rogowski ACF2004_1.....	74
INDEX	75

1. Purpose of this document

This document describes the universal measurement device for heavy-current quantities LINAX PQ5000-MOBILE. It is intended to be used by:

- Installation personnel and commissioning engineers
- Service and maintenance personnel
- Planners

Scope

This handbook is valid for all hardware versions of the LINAX PQ5000-MOBILE. Some of the functions described in this document are available only, if the necessary optional components are included in the device.

Required knowledge

A general knowledge in the field of electrical engineering is required. For assembly and installation of the device knowledge of applicable national safety regulations and installation standard is required.

2. Scope of supply

Upon receive of delivery check device and supplied accessories for completeness and integrity.

The scope of supply depends on the ordered variant.

Image	No.	Description	o.k.
	1	Power quality analyzer PQ5000-MOBILE with 5 test leads for voltage inputs including plug-on dolphin clamps	<input type="checkbox"/>
	1	Power adapter with plug kit	<input type="checkbox"/>
	1	WLAN Access Point Dongle	<input type="checkbox"/>
	1	Carrying bag	<input type="checkbox"/>
	1	Device handbook (German or English) including test report	<input type="checkbox"/>
	1	Optional: 4-phase current probe ACF 2004_1 2000 A	<input type="checkbox"/>
	4	Optional: Clamp-on probes 10A/1V	<input type="checkbox"/>
	4	Optional: Clamp-on probes 100A/1V	<input type="checkbox"/>
	4	Optional: Clamp-on probes 1000A/1V	<input type="checkbox"/>
	1	Optional: GPS receiver 16x-LVS	<input type="checkbox"/>
	..	Optional: IP67 protected Ethernet cable (RJ45), 5m	<input type="checkbox"/>

Leads for voltage measurement

For security reasons leads for voltage measurement are equipped with the following fuse:

SIBA, type 7017240, 6.3 x 32mm, very fast acting
FF 500mA / 1000V / 30kA



The fuse should only be replaced by a fuse of the same type.

To replace the fuse the probe can be screwed on.



Do not replace fuse again if failure is repeated. Repeated failure indicates a defective condition that will not clear with replacement of the fuse. Refer condition to a qualified technician.

3. Device overview

3.1 Short description

By means of the mobile measurement solution LINAX PQ5000-Mobile the operational aspects of the energy supply can be verified:





- Quality of supply
- Availability of supply
- Evaluation of changes or improvement measures
- Energy flow analysis

This measurement solution supports campaigns for repeated measurements at the same locations. For that, a configuration manager can handle up to 20 different device settings. The device can also have a WLAN access point for connecting mobile devices and provides all data for evaluation via its own website. In order to be able to validate the power quality at the measuring location, the duration of the measurement should be at least 7 full days.

A full parameterization of all device functions can be performed via a web browser. The PQ5000-Mobile fulfills all requirements of a class A device in accordance with the power quality standard IEC 61000-4-30 Ed.3.





The device is available in different variants. The nameplate on the device provides information about the given version.

Devices with manufacturing date from 20/15 have a built-in [UPS](#) as a standard.

LINAX PQ5000-Mobile		
MAC:	00:12:34:23:00:49	
Default SSID:	PQmobile:23:00:49	
Default Key:	12345678	
Encryption:	WPA/WPA2	
WLAN:	172.16.0.1	
LAN:	192.168.1.101	
PQ5000MOB-3A9D1		
Ord.:	000/123456/123/001	
Man:	20 / 15	
Li-Po Battery	4.5Wh	
		

Name plate of a device with

- **[3]**: Connector for Rogowski probe
- **[A]**: 4-phase Rogowski current probe 2000A
- **[9]**: GPS time synchronization (GPS receiver not in scope of supply)
- **[D]**: Device handbook German
- **[1]**: With UPS

Symbol	Meaning
	Device may only be disposed of in a professional manner!
	Double insulation, device of protection class 2
	CE conformity mark. The device fulfills the requirements of the applicable EU directives.
	Caution! General hazard point. Read the operating instructions.

3.2 Operation and evaluation

No software is required for the parameterization of the device or the evaluation of the measurement results. The WEB interface of the device provides all required functions. These can be used via mobile phone, tablet or laptop via the LAN or WLAN interface.

- Measurement data visualization
- Status bar for network LAN + WLAN, alarms, recording
- Service functions
- PQ Easy-Report for compliance reports
- Complete device parameterization
- Support for measurement campaigns (up to 20 configurations)
- Data export in CSV format (load profiles, waveform, event lists)

3.3 Measurement data

The device provides measurements in subcategories:

- Instantaneous values:** Present TRMS values and associated min/max values for the analysis of the present system state
- Energy:** Provides information about the current energy consumption (power mean-values with trend), the time-related energy consumption (load profiles) and the total energy consumption.
- Harmonics:** Total harmonic distortion THD/TDD, individual harmonics and their maximum values, phase angle of the harmonics
- Phasor diagram:** With the overview of all voltage and current phasors and the phase sequence check it can be clearly determined if the device is connected correctly.
- Waveform** of current and voltage inputs
- Events:** Provides chronological lists of all PQ events and the occurrence of monitored (user-defined) alarms and events. The operator list contains system events, such as configuration changes, power up/down, reset operations, firmware updates and much more, which may have an impact on the consistency of measurement data.
- PQ statistic:** Gives access to the result of the statistical power quality analysis. The user can directly perform conformity assessments to the standards EN 50160, IEC 61000-2-2 / 2-4 / 2-12, GB/T, IEEE 519 or other user-defined limit sets or directly create conformity reports (PQ-Easy Report).

3.4 Device usage

The planning of the device usage, performing the measurement and then evaluating the recorded data is described in the following chapters.

- [Preparation of the measurement application \(Chap. 4\)](#): Using the website the device functionality can be configured via LAN or WLAN interface
- [Connecting the device on-site \(Chap. 6\)](#)
- [Installation check \(Chap. 7.2\)](#)
- [Performing the measurement \(Chap. 7\)](#)
- [Evaluation of recorded data \(Chap. 8\)](#)

4. Preparation of the measurement application

4.1 Connecting to the measurement device

4.1.1 Connection via LAN interface

Before devices can be connected to an existing Ethernet network, you have to ensure that they will not disturb the normal network service. The rule is:



None of the devices to connect is allowed to have the same IPv4/6 address than another device already installed

This also applies if the network only consists of a PC and the measuring device.

The device supports both IPv4 and IPv6 communication. IPv4 communication is activated by default; IPv6 can be activated additionally via configuration.

As soon as PC and measurement device are in the same network, the website of the device may be accessed using a browser. The assignment of the network settings of a PC is shown in [Annex B](#).



The recommended browsers are Google-Chrome and Firefox.

For configuring via Webbrowser you have to display the device website using:

- IPv4 communication: `http://IPv4_addr`, e.g. `http://192.168.1.101`
- IPv6 communication: `http://[IPv6_addr]`, e.g. `http://[fd2d:bb44:97f1:3976::1]`

If the secure communication via https is activated and the root certificate installed, you have to use https instead of http for displaying the website

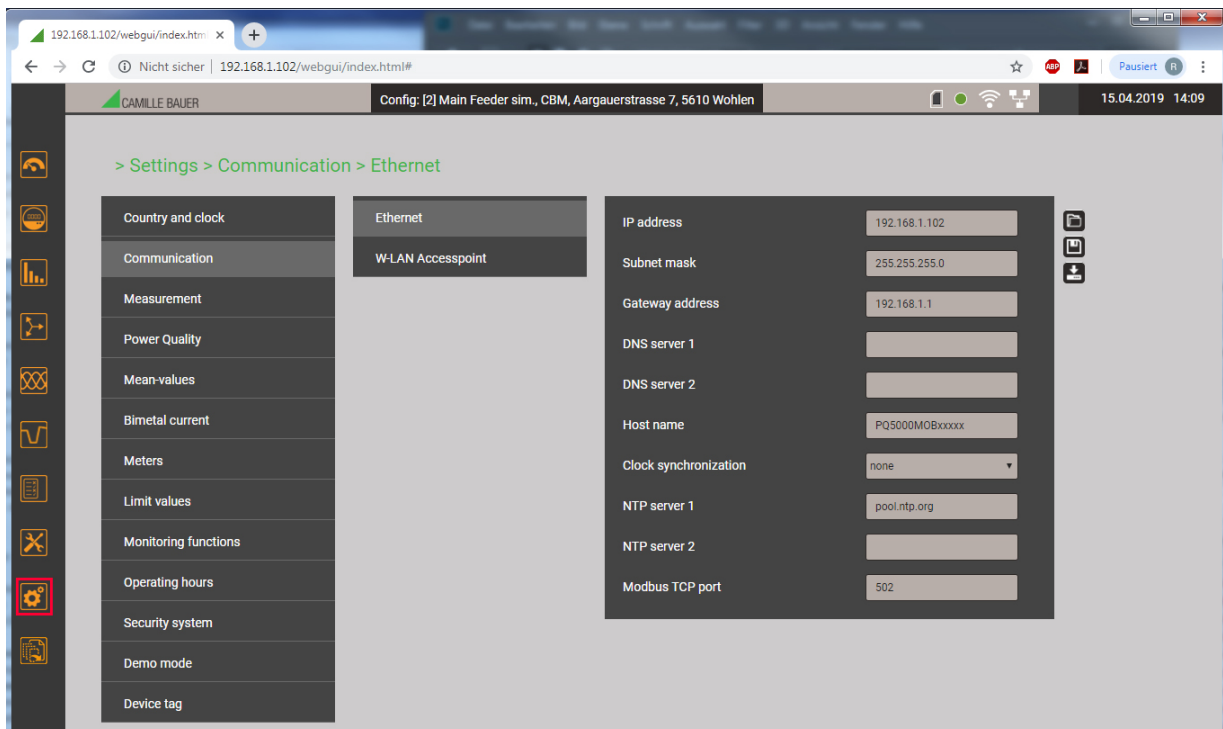

If, for example, a device needs to be integrated into an existing network, the network settings can be modified via the menu Settings | Communication | Ethernet. The corresponding parameters are described on the next page.



If the IP address of the Ethernet interface is changed and the configuration stored in the device, the website of the device must be reloaded via the new IP address.

Hint: The device supports up to 20 different configurations, but the Ethernet settings are the same for all of them.

Network settings (Communication | Ethernet)

The following settings have to be arranged with the network administrator:

• IPv4/6: IP address	Must be unique , i.e. may be assigned in the network only once
• IPv4: Subnet mask	Defines how many devices are directly addressable in the IPv4 network. This setting is equal for all the devices. Examples
• IPv4/6: Gateway address	Is used to resolve addresses during communication between different networks. It should contain a valid address within the directly addressable network
• IPv4/6: DNS-Server x	Is used to resolve a domain name into an address, if e.g. a name (pool.ntp.org) is used for the NTP server. Further information
• IPv6: Prefix length	Is comparable to the subnet mask in IPv4 networks; it is the number of the leftmost bits of the site prefix which need to be identical for direct communication.
• Hostname	Individual designation for each device. Via the hostname the device can be uniquely identified in the network. Therefore for each device a unique name should be assigned.
• NTP-Server x	NTP servers are used as base for time synchronization
• Modbus TCP enabled	If Modbus/TCP communication is not required it may be disabled for security reasons.
• Modbus/TCP port	Selection of the TCP port to be used for Modbus/TCP communication. Standard setting is 502. See also TCP ports .

 If a USB to Ethernet adapter is used, the IP address of this local network can be assigned to an address in the network of the LAN interface of the measurement device, e.g. 192.168.1.100. This way the standard interface of the device does not need to be changed.



IPv4: Subnet mask

For a direct communication between device and PC both devices need to be in the same network when the **subnet mask** is applied:

Example 1	decimal	binary
IP address	192.168. 1.101	11000000 10101000 00000001 01100101
Subnet mask	255.255.255.224	11111111 11111111 11111111 11100000
	variable range	xxxxxx
First address	192.168. 1. 96	11000000 10101000 00000001 01100000
Last address	192.168. 1.127	11000000 10101000 00000001 01111111

► The device 192.168.1.101 can access directly the devices 192.168.1.96 ... 192.168.1.127

Example 2	decimal	binary
IP address	192.168. 57. 64	11000000 10101000 00111001 01000000
Subnet mask	255.255.252. 0	11111111 11111111 11111100 00000000
	variable range	xx xxxxxxxx
First address	192.168. 56. 0	11000000 10101000 00111000 00000000
Last address	192.168. 59.255	11000000 10101000 00111011 11111111

► The device 192.168.57.64 can access directly the devices 192.168.56.0 ... 192.168.59.255

In private networks only reserved IP address ranges may be used, with subnets being most common in the 192.168.x.x/16 network (see examples above). Alternative private networks are: 10.0.0.0/8 or 172.16.0.0/12 (used by the WLAN access point).

Time synchronization via NTP protocol

For the *time synchronization* of devices via Ethernet *NTP* (Network Time Protocol) is the standard. Corresponding time servers are used in computer networks, but are also available for free via Internet. Using NTP it's possible to hold all devices on a common time base.

Two different NTP servers may be defined. If the first server is not available the second server is used for trying to synchronize the time.

If a public NTP server is used, e.g. "pool.ntp.org", a name resolution is required. This normally happens via a **DNS server**. So, the IP address of the DNS server must be set in the communication settings of the Ethernet interface to make a communication with the NTP server, and thus time synchronization, possible. Your network administrator can provide you the necessary information.

The time synchronization of the standard interface can be performed via a [GPS receiver](#) (Chap. 6.2) as well.

TCP ports

The TCP communication is done via so-called ports. The number of the used port allows determining the type of communication. As a standard Modbus/TCP communication is performed via TCP port 502, NTP uses port 123. However, the port for the Modbus/TCP communication may be modified. You may provide a unique port to each of the devices, e.g. 503, 504, 505 etc., for an easier analysis of the communication traffic. Independent of these setting a communication via port 502 is always supported. The device allows at least 5 connections to different clients at the same time.

Firewall

Due to security reasons nowadays each network is protected by means of a firewall. When configuring the firewall you have to decide which communication is desired and which have to be blocked. The TCP port 502 for the Modbus/TCP communication normally is considered to be unsafe and is often disabled. This may lead to a situation where no communication between networks (e.g. via Internet) is possible.

MAC address

For uniquely identifying Ethernet connections in a network, a unique MAC address is assigned to each connection. Compared to the IP address, which may be modified by the user at any time, the MAC address is static. The MAC address of the LAN interface is given on the nameplate.

Communication tests

Via the service menu on the device website you may check if the selected network structure is valid. The device must be able to reach the DNS server via gateway. The DNS server then allows resolving the URL of the NTP server to an IP address. The Standard Ethernet interface serves as interface for the communication tests.

- Ping: Connection test to any network device (initial: gateway address)
- DNS: Test, if the name resolution via DNS works (initial: URL of NTP server)
- NTP: Test, if the selected NTP-Server is in fact a time server (stratum x)
- SFTP: Test, if access to SFTP server works. A test file will be copied to the base directory of the server.

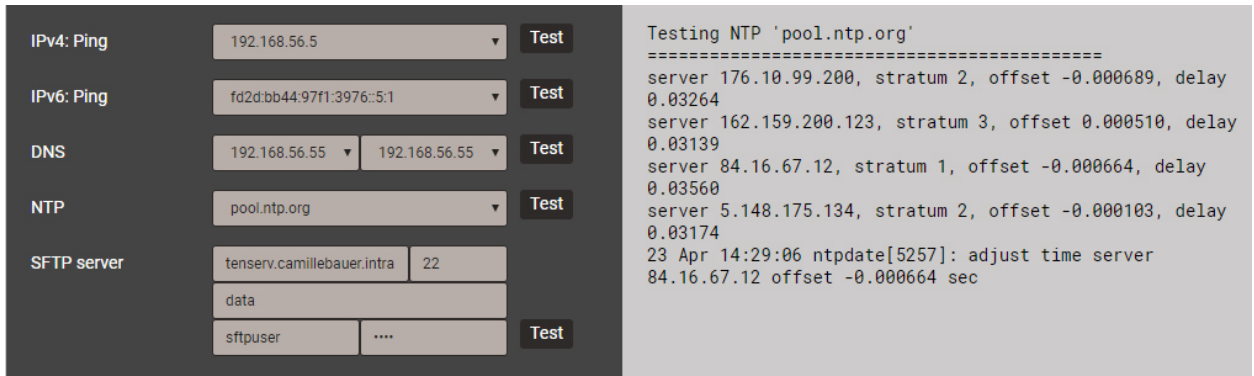

The screenshot shows a web interface for communication tests. On the left, there are five test categories: IPv4: Ping (192.168.56.5), IPv6: Ping (fd2d:bb44:97f1:3976::5:1), DNS (192.168.56.55), NTP (pool.ntp.org), and SFTP server (tenserv.camillebauer.intra, 22, data, sftpuser). Each category has a 'Test' button. On the right, the results of an NTP test are displayed:

```
Testing NTP 'pool.ntp.org'
=====
server 176.10.99.200, stratum 2, offset -0.000689, delay 0.03264
server 162.159.200.123, stratum 3, offset 0.000510, delay 0.03139
server 84.16.67.12, stratum 1, offset -0.000664, delay 0.03560
server 5.148.175.134, stratum 2, offset -0.000103, delay 0.03174
23 Apr 14:29:06 ntpdate[5257]: adjust time server 84.16.67.12 offset -0.000664 sec
```

NTP server test

4.1.2 Connection via WLAN interface

Via the WLAN dongle up to 10 devices (mobile phone, tablet, laptop or similar) can be connected wireless.

- For devices with camera the QR code on the nameplate can be used for joining directly the network of the measurement device. Depending on the mobile device used, an App for scanning the QR code may be required. Shown example: iPhone.
- All other devices can be connected to the measurement device by establishing a connection to the WLAN access point given on the nameplate (PQmobile:23:xx:xx).



Call the device website via http://<ip_addr>. The default setting of the device IP address is 172.16.0.1.



If the IP address of the WLAN interface is changed and the configuration stored in the device, the website of the device must be reloaded via the new IP address.

Hint: The device supports up to 20 different configurations, but the WLAN settings are the same for all of them.

4.1.3 Resetting the network settings

If the communication settings of the communication interface are no longer known or an activated whitelist prevents access to the device, they can be reset to the default settings via the keys on the device.



Function	Procedure and result
Resetting the WLAN interface to the default setting 172.16.0.1	Press <RESET> for at least 3 seconds: The assigned LED flashes. The reset is finished, as soon as the LED shows the state before the reset again.
Resetting the LAN interface to the default settings of IPv4 and IPv6 Deactivating an active whitelist.	Press <RESET> and <RECORD> for at least 3 seconds: The assigned LEDs flash. The reset is finished, as soon as the LEDs show the state before the reset again.

4.2 Parameterization of the device functionality

4.2.1 Configuration manager

This measurement solution supports campaigns for repeated measurements at the same locations. For that, a configuration manager can handle up to 20 different device settings.

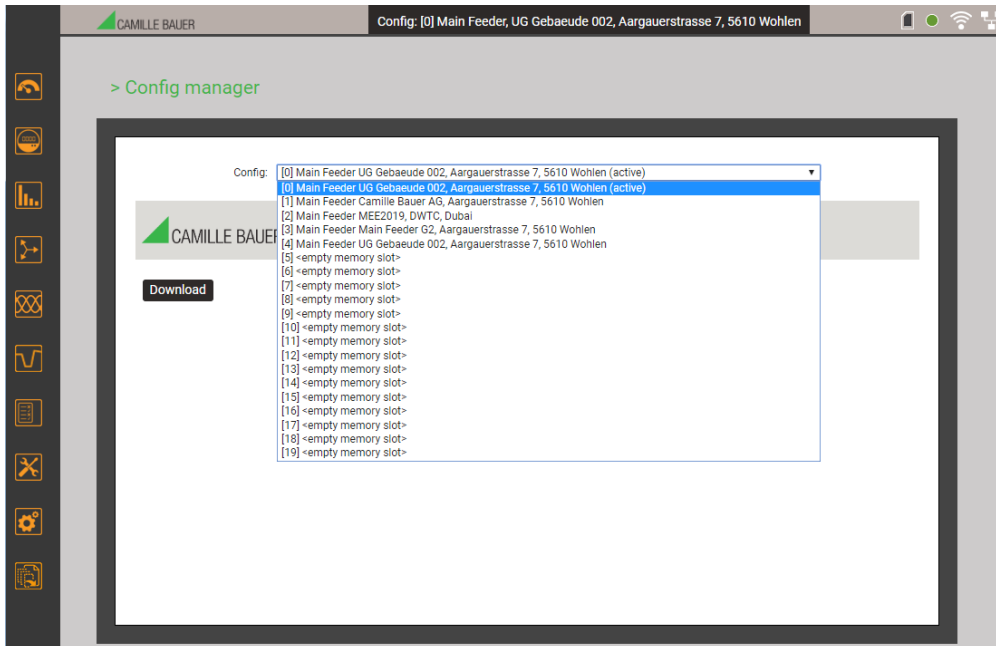

The administration of the device configurations is done via the configuration manager.

- The active configuration is marked with (active) and also visible in the status bar
- <empty memory slot> means, that this configuration hasn't been used yet\
- If the active configuration is selected, the menu **Download** is available
 - Download: Save the active configuration as XML file on the PC
- If a none active configuration is selected, the menu changes to **Activate configuration** **Delete** **Download**
 - Activate configuration: This configuration is activated in the device
 - Delete: The selected configuration will be deleted and then display as <empty memory slot>
Hint: The active configuration cannot be deleted
 - Download: Save the selected configuration as XML file on the PC
- If an empty configuration is selected, the menu changes to **Upload**
 - Upload: You may upload a configuration (XML file) from the PC

Each [device configuration](#) (chap. 4.2.2) is created via the Settings menu.



For the subsequent data analysis, the used configuration during data recording must be reactivated in the device

ATTENTION: If the configuration used during data recording has been changed or is no longer available, an evaluation of the data may no longer be possible.

4.2.2 Device configuration

A full parameterization of all functions of the device can be performed via the settings menu on the website.

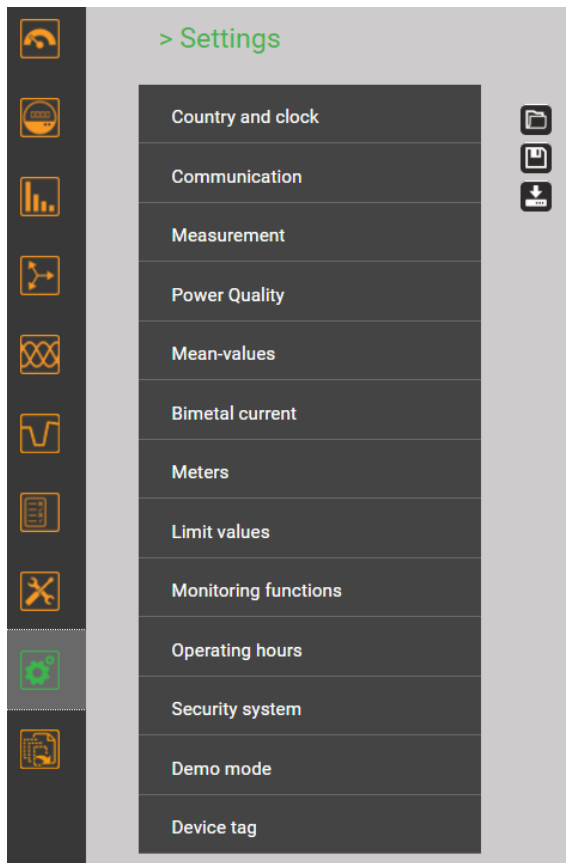

Upload a configuration from computer

The configuration data of the selected file will be directly loaded into the device. At the same time the active configuration in the configuration manager is updated. You can select, if the parameters shown in the below picture should be overwritten or retained by the values in the file to load.

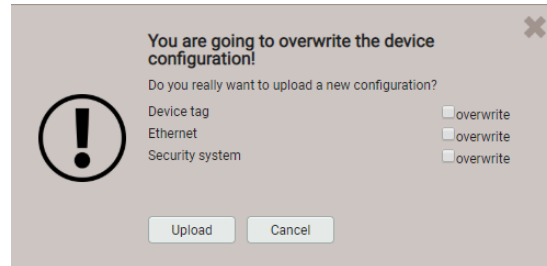

Save current settings

You have to select the slot of the configuration manager to overwrite. The settings will be activated in the device as well.

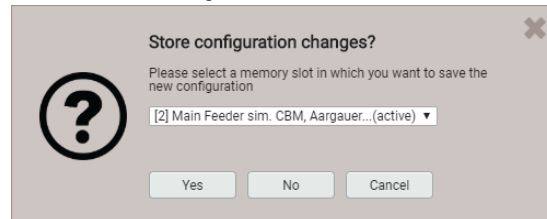

Store configuration on computer

Subgroups of the settings menu

- **Country and clock:** display language, date format, time zone, clock synchronization, time/date (only if there is no time synchronization)

Hint: Although changing the language has immediate effect on the display, such a change must be saved in the device.

- **Communication:** Settings of the communication interfaces [Ethernet](#) (4.1.1) and [WLAN](#) (4.1.2). In addition, a [SFTP server](#) may be defined, to push user definable data files to.

Hint: The communication settings are valid for all configurations

- **Measurement:** System type, sense of rotation, nominal values of U/I/f, sampling, [reference arrow system](#) (annex A) etc.

Hints

- **U / I transformer:** The primary to secondary ratio is used only for converting the measured secondary to primary values, so e.g. 100 / 5 is equivalent to 20 / 1. The values do not have any influence on the display format of the measurements.
 - **Nominal voltage:** Is used as the 100% reference for monitoring power quality events and corresponds to the declared input voltage U_{in} in accordance with IEC 61000-4-30
 - **Nominal current:** Used for scaling the harmonic content [TDD](#) of the currents
 - **Maximum primary values U/I:** These values are used only for fixing the display format of the measurements. This way the resolution of the displayed values can be optimized, because there is no dependency to installed transformers.
 - **Synchronous sampling:** yes=sampling is adjusted to the measured system frequency to have a constant number of samplings per cycle; no=constant sampling based on the selected system frequency
 - **Reference channel:** The measurement of the system frequency is done via the selected voltage input
- **Power quality** (Chap. 4.5): Definition of parameters for monitoring the PQ events. The default values of the trigger thresholds and hystereses are set to the common values of the EN50160 for a public low-voltage distribution system.

User-specific limits for the evaluation of the PQ statistic can also be set.

- **Mean-values | standard quantities:** The interval time for the predefined power mean values can be defined here; typical interval: 15 min
- **Mean-values | user defined quantities:** Selection of up to 12 quantities with a common averaging interval for determining their mean-values
- **Bimetal current:** Selection of the response time for determining [Bimetal currents](#) (annex A.4)
- **Meters | Standard meters:** [Meter resolution](#) (annex A.4)
- **Meters | User defined meters:** Up to 12 base quantities (Px,Qx,Q(H1)x,Sx,Ix) can be selected for free definable meters; [Meter resolution](#) (annex A.4)
- **Meters | Meter logger:** Selection of the reading interval
- **Limit values:** Selection of up to 12 quantities to monitor, [limit values](#) (4.5.1) for ON/OFF, event text (only 'a'...'z', 'A'...'Z' and '0'...'9' allowed)
- **Monitoring functions:** Definition of up to 8 [monitoring functions](#) (4.5.2) with up to three inputs each, delay times for ON / OFF and event text (only 'a'...'z', 'A'...'Z' and '0'...'9' allowed)
- **Operating hours:** Selection of the running condition for up to 3 operating hour counters
- **Security system:** Definition of the [security system](#) (RBAC, https, whitelist)
Hint: An activated security system is valid for all configurations
- **Demo mode:** Activation of a presentation mode; measurement data will be simulated. Demo mode is automatically stopped when rebooting the device.
- **Device tag:** Definition of different texts mainly used for report generation, such as device tag, document title, device location and others. Note: Only the characters 'a'...'z', 'A'...'Z' and '0'...'9' may be used.
- **Data export scheduler:** Via tasks may be defined to be executed regularly. Each time such a task is running, it creates a data file to be transferred to a SFTP server and/or to be stored locally on the device. Via local configuration tasks can be enabled or disabled only.

4.3 Security system

There are several security mechanism implemented in the device which can be activated to provide a comprehensive access protection to all device data.

- The **role-based access control (RBAC)** system allows restricting the access to measured data, configuration settings and service functions to the rights granted to the present user. For access via website this is done by reducing the available menus and / or providing only read access rights to specific services. For accessing data via external applications an API (Application Programming Interface) key is required, which needs to be implemented as a special user.
- **HTTPS** provides encrypted communication using TLS (Transport Layer Security)
- Via **client whitelist** access to the device can be restricted to specific clients with definable IP addresses
- **Communication blocking:** Communication services, such as Modbus/RTU, Modbus/TCP or SYSLOG are blocked by default and must be actively enabled via configuration. This way unauthorized access may be prevented and possible intruding points eliminated.
- **Security log:** The device stores all security related messages in a separate list accessible via the service menu. The content of this list can also be transferred to a central log-server using the **SYSLOG** protocol for security auditing.

If the device is equipped with a display, restrictions defined in the security system also take effect when operating the device via the local display. It is also possible to restrict users to local access only.

4.3.1 RBAC management

Each access to device data via website, local display or external software applications can be comprehensively protected using the role-based access control (RBAC) system. This way, access to measured value information, the change of configuration parameters or the resetting / deletion of measurement data can be individually adapted to the role of the active user.

Note: All settings of the security system are stored in the device in encrypted form only; login credentials are never transmitted in plain text.

A maximum of 8 users is supported

➤ **2 pre-defined standard users**

- *admin*: A user with administrator rights (Default setting password: „CBM_1234“)
- *anonymous*: The standard user for access via device website. Its permissions determine what can be displayed or changed via the website without a user having to log in.

➤ **Up to 6 definable users or API keys**

Users or API keys may be created by each user with write access to the settings of the security system. In any case, each user with a web login can change the password of its own account.

Application programming interface (API) keys are used to allow applications to access device data via REST interface (communication via http/https protocol). Such keys are timely unlimited and have either read-only permissions, all permissions or all permissions except security.

The pre-defined administrator or any other user with full access rights to the settings of the security system can:

- Change its own credentials (user name and/or password)
- Change the credentials (user name and/or password) of any other user
- Freely define the permissions of the standard user *anonymous*
- Create new users up to a maximum of 6
- Restrict users to local operation only (no login via website)

Adding users / API keys

In addition to the 2 predefined users a maximum of 6 users or API keys may be created. To do so, use “Add user / API key” and select the type of user to be created.

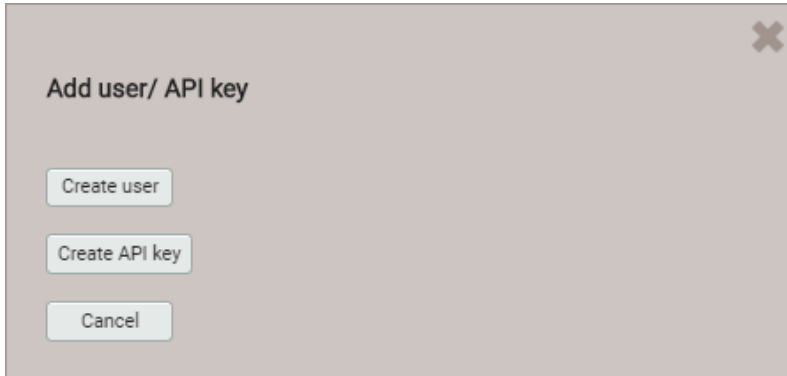

Users: During password definition the requirements for a secure password are checked and the result is displayed. Each new user can be created based on the permission template of an already existing user, but all of these permissions may be changed later.

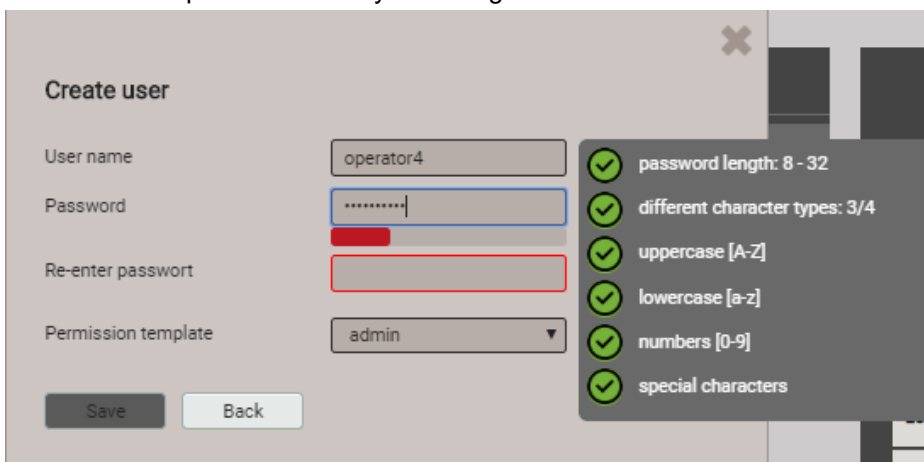



When defining / changing passwords the following restrictions must be considered:

- Password length 8 up to 32 characters
- At least three different types of characters must be used (uppercase, lowercase, numbers, special characters)

CAUTION: If login credentials (user name and / or password) of users with write access to the security system are changed, this information must be kept safe. For security reasons resetting the RBAC system can only be done at the factory, no backdoor is implemented.

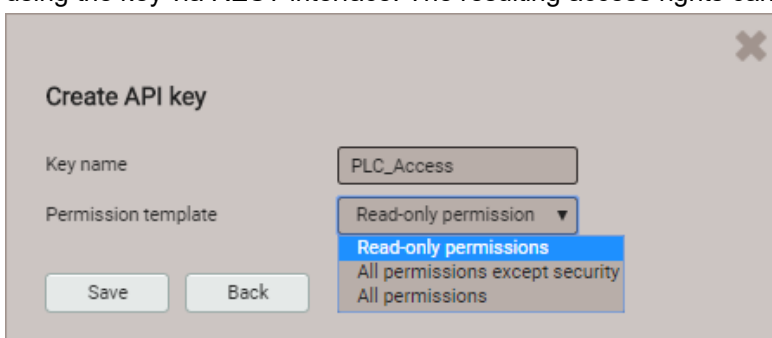
API key: Along with the key name you have to define the permissions to be granted to the application using the key via REST interface. The resulting access rights cannot be changed afterwards.



Once the API key is created it can be displayed using  “Show API key”

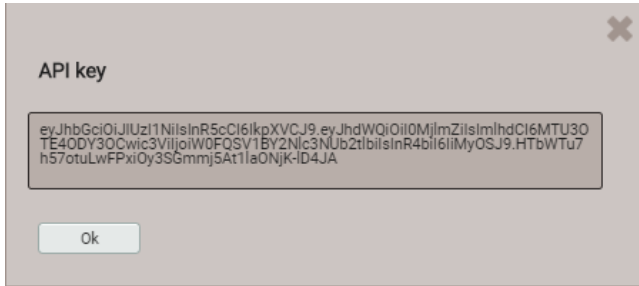

When the application wants to communicate via REST interface with the device, it has to provide the API key and the session token via the cookie field in the request header, e.g.:

Cookie:







```
AccessToken=eyJhbGciOiJIUzI1NiIsInR5cCI6IkpXVCJ9.eyJhdWQiOiIiIiwiaWF0IjoxNTc5MTU0NDc0LjZzdWIiOiJhbm9ueWlvdXMiLCJ0eG4iOiIxOTIuMTY4LjU4LjExNCJ9.LiLjUjcs2bZAmYHlvdMXTA1r87gxUX-3kZ4cfZ6jdMc;
sessionToken={5d1ca47c-8d38-4a08-85d5-feb941fa20}
```

Further information is provided in the document “http interface SINEAX PQx000”

Assignment of user rights

The assignment of the user rights granted for operation is done via the menu Settings | Security system | Users and permissions:

Users and Permissions		enabled						
		Add user/ API key						
		admin	localgui	anonymous	operator1	operator2	operator3	[API]AccessToken
Local account (no weblogin)		<input type="checkbox"/>	<input checked="" type="checkbox"/>	<input type="checkbox"/>	<input type="checkbox"/>	<input type="checkbox"/>	<input type="checkbox"/>	<input type="checkbox"/>
Instantaneous values								
Energy								
Harmonics								
Phasor diagram								
Waveform								
Events								
PQ statistic								
Service								
Reset values								
Reset/Update device								
Audit Log								
Use IO simulation								
Settings								
Basic device settings								
Measurement								
Communication								
Security system								

-  Measurements or settings can be displayed
-  Measurements or settings cannot be displayed
-  Settings can be changed
-  Settings cannot be changed
-  Field not selectable
-  Change a user's login credentials



Overview of the access rights of each possible user

4.3.2 User log in / out via website

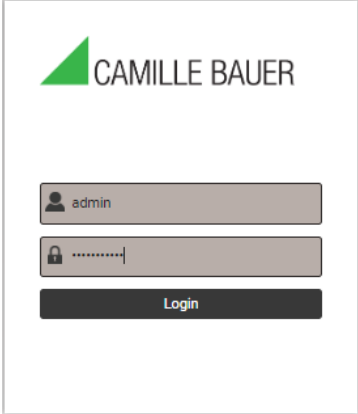

a) If “anonymous” has no granted permissions

Via website	Remarks
	<p>1) Enter user name and password 2) Press <ENTER> or select “Login” If successful, depending on the permissions of the user logged in, the appropriate website is displayed</p>

b) If “anonymous” has granted permissions

Via website	Remarks
	<p>1) Click on the symbol  2) Enter user name and password. On first login use the default settings admin / CBM_1234. 3) Press <ENTER> or select “Login” If successful, depending on the permissions of the user logged in, the appropriate website is displayed</p>

c) If another user is already logged in

Via website	Remarks
	<p>Log out the current user by selecting “Logout”</p> <p>1) Click on the symbol  2) Enter user name and password 3) Press <ENTER> or select “Login” If successful, depending on the permissions of the user logged in, the appropriate website is displayed</p>

4.3.3 Whitelisting clients

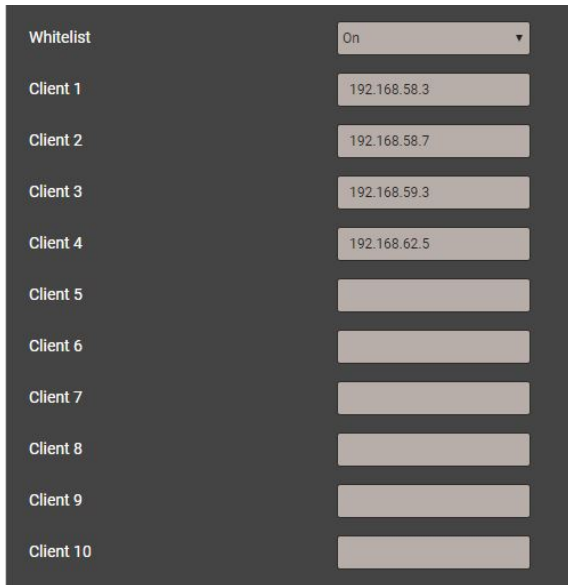

It is possible to define a list of IPv4 and/or IPv6 addresses of up to 10 clients allowed to have access to the device. All other clients will be blocked. Enable the whitelist via the *Settings* of the *Security system* in the item *Whitelist*.



If a DHCP server is used in the system, clients may get different IP addresses on each startup, losing this way access to the device.

If a device is no longer accessible you can reset its IP address (LAN), deactivating the whitelist at the same time.

4.3.4 Secure communication using https

According to Enel specifications https communication is activated by default. This protocol provides encrypted communication using TLS (Transport Layer Security). Such as bidirectional encryption of communications between a client and server protects against eavesdropping and tampering of the communication, by creating a secure channel over an insecure network.

Before HTTPS communication can be used a root certificate needs to be installed. The user can either use a Camille Bauer certificate (default setting) or its own customer certificate. This may be changed when defining the Settings of the Security system.

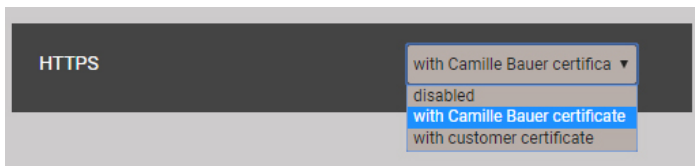

Camille Bauer certificate

The Camille Bauer Metrawatt root certificate is provided via <https://camillebauer.com/pq5000mob-en>). It needs to be installed before the browser is started.

Once the certificate is downloaded to the local computer the certificate can be installed manually. Just double-click on the file. **Install certificate**, then select **Place all certificates in the following store**, **Browse** and select **Trusted Root Certification Authorities**. **Finish** the Import Wizard.

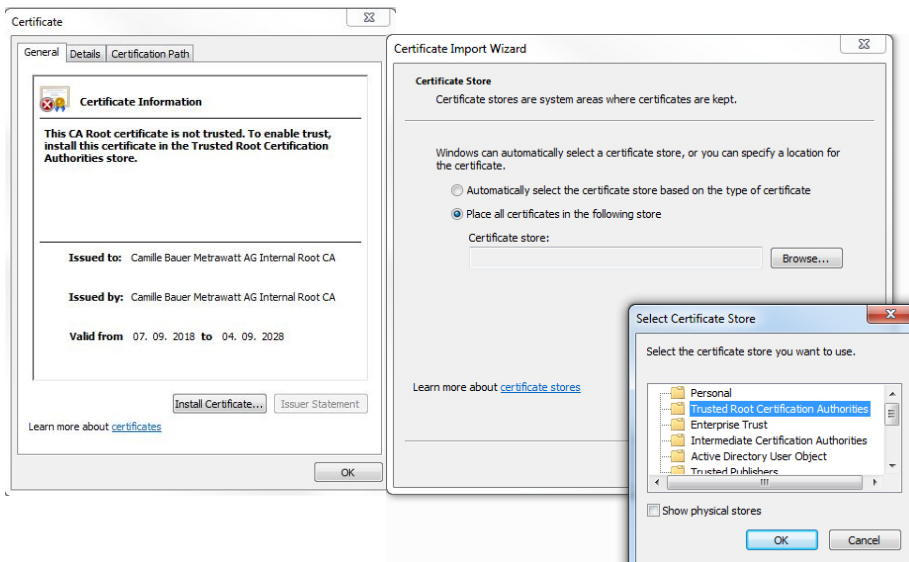

The imported certificate is valid for all devices of the PQ, AM, DM and CU series.

Agree to install the certificate if the below security warning appears:



Customer certificate

You may also use a customer server certificate with a private key, but for that you first need to change the *Settings* of the *Security* system in the item *Web Security*.

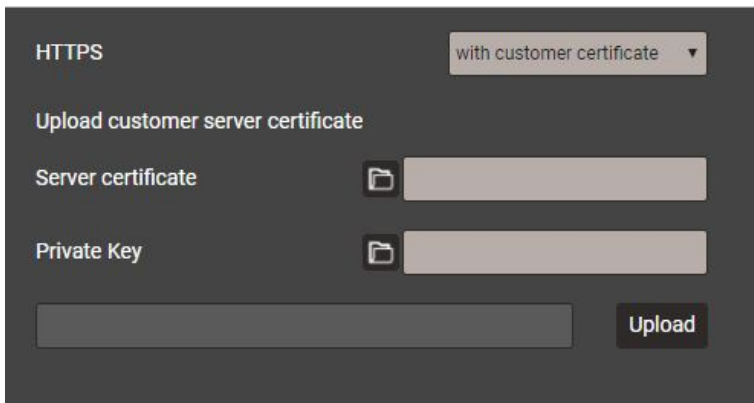

You may use https communication also by ignoring any browser warning and establishing an **unsecure** connection to the device. However, for security reasons you should not work like that in the intended network environment.

4.3.5 Audit log (SYSLOG)

Security related events, such as ...

- a computer establishing a connection to the device
- a user logged in /out
- a failed login attempt
- each changing of the device configuration
- the view of the security log by a user
- etc.

are logged in a security log accessible via the service menu.

Navigation: [K] [←] [1] [2] [3] [4] [→] [+5>>] Results per page: 25 [↻]

Filter: Emergency Alert Critical Error Warning Notice Info Debug

Time	PID	Priority	IP address	User name	Message
17.01.2020, 09:35:59	cb-gui[2126]	Notice	192.168.57.65:54375	admin	User reviewed latest security event log (allow)
17.01.2020, 09:35:54	cb-gui[2126]	Notice	192.168.57.65:54375	admin	User logged in successfully
17.01.2020, 08:33:30	sshd[2436]	Info	192.168.58.58:11348	root	Accepted password ssh2
17.01.2020, 08:31:18	sshd[2420]	Info	192.168.58.58:11318	root	Accepted password ssh2
17.01.2020, 08:31:17	sshd[2416]	Info	192.168.58.58:11315	root	Accepted password ssh2
17.01.2020, 08:24:56	cb-gui[2126]	Info	192.168.57.65:53539	admin	User logged out successfully
17.01.2020, 08:04:45	cb-gui[2126]	Notice	192.168.57.65:53387	admin	User reviewed latest security event log (allow)
17.01.2020, 08:02:59	cb-pq3000[2120]	Notice			The device was power off on Fri Jan 17 07:57:31 2020
17.01.2020, 08:02:59	cb-pq3000[2120]	Notice			The device was power on Fri Jan 17 07:57:31 2020
17.01.2020, 08:02:59	cb-pq3000[2120]	Notice			Firmware update was on Fri Jan 17 08:01:07 2020

Example of a security log: The severity of each message is shown in a color code, which may also serve as filter criteria.

Each entry into this list may, if activated, also be transferred to a central log-server using the **SYSLOG** protocol for security auditing. This transfer may be performed based on UDP, TCP or TLS. The settings of the Syslog server are available via Settings | Communication | Syslog server:

Syslog protocol	TCP
Host	tenserv.camillebauer.com
Port	514

4.4 PQ monitoring

Power quality monitoring provides both a statistical evaluation, allowing an assessment of compliance with standards (e.g. EN 50160) or supply contracts, as well as records of events in the grid (e.g. power voltage dips). This facilitates the analysis of causes and effects. Conformity reports may also be created directly via the website of the device.

4.4.1 PQ events

The device monitors all voltage events in accordance with IEC 61000-4-30. The default values of the trigger thresholds correspond to the common values of the EN 50160 for a public low-voltage distribution system, but can be changed by the user to individual needs.

In addition to the requirements of IEC 61000-4-30 the device can monitor current swells and frequency anomalies.

Monitored events	Threshold	Hysteresis	Reference value
Voltage dip	90%	2%	Nominal voltage
Voltage interruption	10%	2%	
Voltage swell	110%	2%	
Rapid voltage change	6%	50% ¹⁾	
Homopolar voltage	50%	2%	
Current swell	120%	2%	Nominal current
Frequency anomaly	lower: 99% upper: 101%	0.5%	Nominal frequency

1) Related to the respective threshold



The device does not verify the user-defined event parameters. If these values are not plausible, events may be not recognized correctly or misclassified. In particular, the trigger threshold for RVC events should not be greater than half of the difference of the threshold values of voltage swell and voltage dip.

Recordings

If any of the above events occurs, the device records both the half-cycle RMS values and the samples of all voltage and current channels. The event recording times can be configured using the menu *Settings* | *Power quality* | *Event recording*:

RMS(1/2): Pretrigger recording	s	1.000
RMS(1/2): Event recording (max.)	s	180.000
Samples: Pretrigger recording	s	1.000
Samples: Event recording	s	4.000

Possible recording times

≤1.0s

≤180.0s

≤1.0s

≤5.0s

Note: The event recording time “RMS(1/2): After triggering” is a maximum recording time. It is reduced to the real event duration + 1s, if the event duration is shorter than the configured time.

Recorded PQ events can be [visualized](#) either via the local display or the webpage of the device.

Mains signalling voltage

The device monitors mains signalling voltages, which are transmitted in the supply system for control purposes, and records them as [events](#) (8.1.3). Typically these are ripple control signals. The user can define the frequency of the signalling voltage, the threshold and hysteresis (related to the nominal voltage) as well as the recording duration in multiples of the measurement interval of 10/12 cycles. The recording duration must not exceed 120s. The ripple control frequency is typically below 3 kHz and can be requested from the local energy provider.

Reference channel		U1
Ripple control frequency	Hz	167
Trigger threshold	%	0.5
Trigger hysteresis	%	0.25
Rec. duration (10/12 cycles)	#	50

4.4.2 PQ statistic

Power quality (PQ) is assessed by a comparison between the PQ parameters measured by the device and the limits of a contract agreed upon.

The assessment period specified in standards is normally at least one week to take into account possible variations between weekdays and weekends. However, [compliance reports](#) may also be created for shorter or longer recording times; the user can freely select an assessment period as a multiple of 10 minutes.

The standard to be verified must be preset in the device and only this standard can be evaluated during the PQ analysis. The standard may be set via the menu *Settings | Power quality | General*. There also the lower limit for the no damage region of the ITIC curve may be defined.

Standard		EN50160 LV
Lower limit ITIC 'no damage'	ms	10

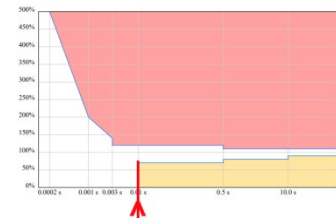



Limit ITIC

Possible choices for the standard are as follows:

- EN 50160 (2010), low voltage, interconnected systems
- EN 50160 (2010), low voltage, island systems
- EN 50160 (2010), medium voltage, interconnected systems
- EN 50160 (2010), medium voltage, island systems
- EN 50160 (2010), high voltage, interconnected systems
- EN 50160 (2010), high voltage, island systems
- IEC 61000-2-2 (2002), public low voltage systems
- IEC 61000-2-4 (2002), industrial and non-public systems up to 35 kV, class 1
- IEC 61000-2-4 (2002), industrial and non-public systems up to 35 kV, class 2
- IEC 61000-2-4 (2002), industrial and non-public systems up to 35 kV, class 3
- IEC 61000-2-12 (2003), public medium voltage systems
- User specific limit sets

The assessment of the PQ statistic is shown in the chapter [Data recording | PQ statistic](#) (8.1.4), including the creation of conformity reports.

Recorded PQ parameter groups

Measurement	Averaging time	Applied limits
Power frequency	10 s	<p><i>The applied limits and time conditions of the preset standards can be seen via the device website.</i></p> <p><i>They can be displayed via the following menu:</i></p> <pre> Settings Power Quality Custom threshold limits (Standard) </pre> <p> <i>Within the same menu user data sets with specific limits and evaluation criteria can be defined</i></p> <p> <i>User specific data sets can also be deleted again.</i></p>
Voltage magnitude	10 min.	
Flicker P _{st}	10 min.	
Flicker P _{lt}	2 h	
Mains signalling voltage	3 s	
Supply voltage unbalance	10 min.	
THDS of voltages	10 min.	
Voltage harmonics	10 min.	
Voltage interharmonics	10 min.	
Current magnitude	10 min.	
Current unbalance	10 min.	
Current harmonics	10 min.	
Current interharmonics	10 min.	

4.4.3 Provision of PQ data

The device can create PQ related data, such as PQ events or PQ statistic, using the standard format PQDIF (**P**ower **Q**uality **D**ata **I**nterchange **F**ormat) acc. IEEE1159.3. The automatic or event-driven generation of such files can be defined via the [Data export scheduler](#) in the Settings menu. By default, daily PQDIF will be created periodically after midnight for the past day and provided in a hierarchical time structure (year, month, day) for [download](#). However, this default creation may be deactivated.

4.5 Alarming

The device supports an alarming concept independent of power quality events. Depending on the user requirements, simple or more advanced monitoring tasks may be realized. The most important objects are limit values on base quantities, monitoring functions and the summary alarm.

4.5.1 Limit values on base quantities

Monitored quantity	Active power system
Limit for ON	2500
Limit for OFF	2480
Event text	Power maximum
List entry	Alarms

Using limit values either the exceeding of a given value (upper limit) or the fall below a given value (lower limit) is monitored.

Limits values are defined by means of two parameters: Limit for ON / OFF. The hysteresis corresponds to the difference between these two values.

Both state transitions OFF→ON and ON→OFF can be recorded as event or alarm in the appropriate lists.

Upper limit: $\text{Limit for ON} \geq \text{Limit for OFF}$

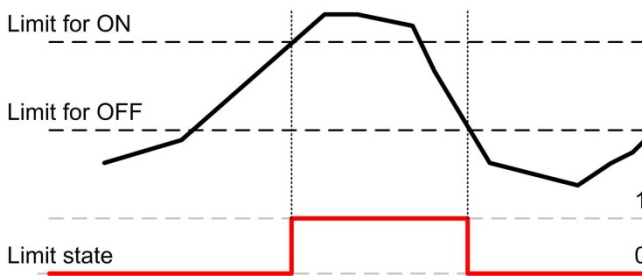

- ▶ The limit value becomes active (1) as soon as the limit for ON state is exceeded. It remains active until the associated measured quantity falls below the limit for OFF state again.
- ▶ The limit value is inactive (0) if either the limit for ON is not yet reached or if, following the activation of the limit value, the associated measured quantity falls below the limit for OFF state again.

Lower limit: $\text{Limit for ON} < \text{Limit for OFF}$

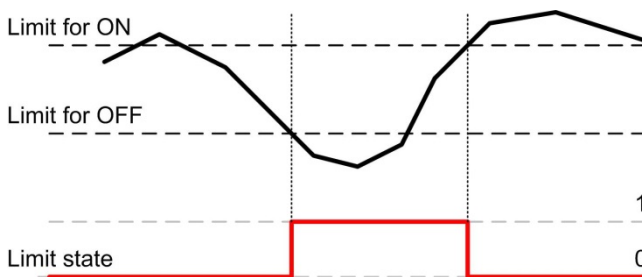

- ▶ The limit value becomes active (1) as soon as the associated measured quantity falls below the limit for ON state. It remains active until the associated measured quantity exceeds the limit for OFF state again.
- ▶ The limit value is inactive (0) if either the associated measured quantity is higher than the limit for ON state or if, following the activation of the limit value, it exceeds the limit for OFF state again.



If the limit for ON state and the limit for OFF state are configured to the same value, the limit value will be treated as an upper limit value without hysteresis.

Limit value states can:

- ... be used as logic input for a [monitoring function](#) (4.5.2)
- ... be recorded as event or alarm in the appropriate lists on each changing

4.5.2 Monitoring functions

By means of monitoring functions the user can define an extended condition monitoring, e.g. for triggering an over-current alarm, if one of the phase currents exceeds a certain limit value.

The states of all monitoring functions

...will be shown in the alarm or event list (via menu "Events")

...build a summary alarm state

The image shows a configuration screen for a monitoring function. At the top, there is a logic diagram with three input boxes labeled 'Limit state 1', 'Limit state 2', and 'Limit state 3'. These inputs feed into a central logic block containing the symbol '≥ 1'. The output of this block is labeled 't1, t2'. Below the diagram, there are four configuration fields: 'Delay time on (t1)' with a unit 's' and a value of '1.0'; 'Delay time off (t2)' with a unit 's' and a value of '1.0'; 'Event text' with the value 'Overcurrent'; and 'List entry' with a dropdown menu showing 'Alarms'.

Logic inputs

Up to three states of limit values or other monitoring functions. Unused inputs will automatically be initialized in a way that they do not influence the output.

Logic function

For the logical combination of the inputs the function AND, NAND, OR, NOR, DIRECT and INVERT are available.

Delay time on

The time a condition must be present until it is forwarded

Delay time off

Time to be waited until a condition, which is no longer present, will be released again

Description

This text will be used for visualization in the alarm list

List entry

- *Alarm / event*: Each state transition will be recorded in the appropriate list
- *none*: No recording of state transitions

Possible follow-up actions

- Visualization of the present state in the alarm list
- Combining the states of all monitoring functions to create a [summary alarm](#) (4.5.3)
- Recording of state transitions as alarm or event in the appropriate lists

4.5.3 Summary alarm

The summary alarm combines the states of all [monitoring functions](#) (4.5.2) to a superior alarm-state of the overall unit. An alarm is signaled with a flashing bell:



Acknowledgment: By acknowledging the summary alarm, the user confirms that he has recognized that an alarm state occurred. The acknowledgment is done automatically as soon as the user displays the alarm overview. This can be done via the menu (Events | Alarms) or by clicking on the flashing bell symbol in the status bar. By acknowledging only the flashing of the alarm symbol stops, the symbol itself remains statically displayed until none of the monitoring functions is in the alarm state.

The **alarm overview** shows, which monitoring functions caused the summary alarm:

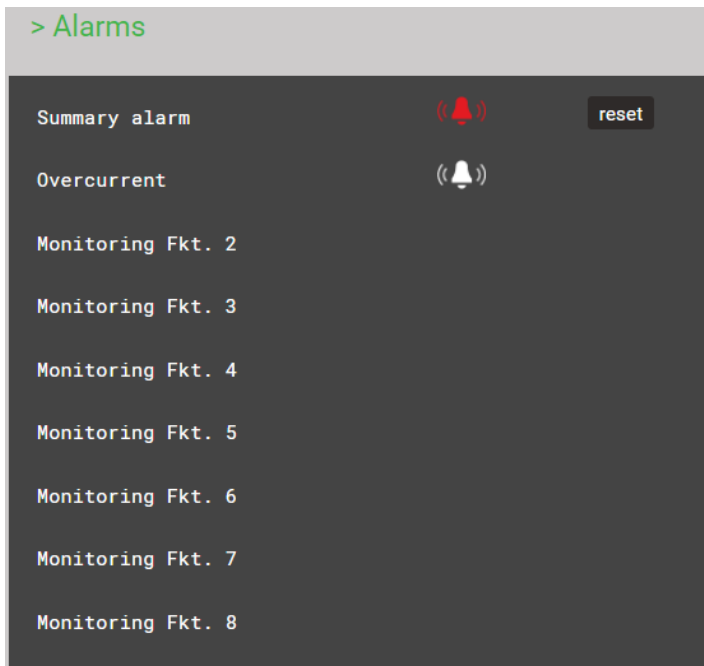

4.6 Measurement information in file format

Using the data export scheduler, measurement information may be provided also in file format. Such files can then:

- periodically being sent to an SFTP server
- locally stored in the device and downloaded via webpage

4.6.1 Creating periodic file data

A periodic generation of PQDIF and / or CSV files can be setup using the Data export scheduler in Settings | Data export. Here tasks may be defined for creating data files with a specific content at regular intervals. These files may be stored locally and / or pushed to a SFTP server.

By default, the scheduler contains a predefined data export task for creating daily PQDIF files for the past day. This task is executed shortly after midnight and stores the files in a hierarchical time structure (year, month, day). However, this task may be deactivated by the user.

By selecting “Add task” new schedules can be set-up. An example is shown below:

The new task “24h_PowerMeans” will generate daily CSV files containing standard mean-values for the past 24 hours.

The files will be both stored locally and pushed to the subfolder PowerMeans of a SFTP server. The [settings](#) of the SFTP server to be used can be defined via Communication | SFTP in the Settings menu.

The transmission window selected here causes a random transmission of the file to the SFTP server within one hour since creation.

The task list then shows two active tasks. The default task “Daily PQDIF” is marked gray to highlight that it cannot be removed but deactivated. If required, an additional action (push to SFTP server) can be added or a transmission window defined.

On the other hand, at any time the newly created task “24h_PowerMeans” can be fully modified, deactivated or deleted.

active	Name	Creation	File	Action
<input checked="" type="checkbox"/>	Daily PQDIF	daily (last 24 hours)	[pqdif] All values in three files	<ul style="list-style-type: none"> • store on local Storage
<input checked="" type="checkbox"/>	24h_PowerMeans	daily (last 24 hours)	[csv] mean values	<ul style="list-style-type: none"> • store on local Storage • push to SFTP server

Via the settings of the local display only the activation / deactivation of the tasks is supported.

CSV formatting

CSV files are intended to transmit statistics of mean values. You may adjust the below parameters to adapt the file format and the content to your requirements.

Separator	Semicolon
Time format	Local time +AB
include min/max values	Yes
Scaled to...	Nominal values
Digits after decimal point	3

Hint: If the time format “Local time+AB” is used, the letters A and B are added to differentiate duplicate entries between 2 and 3 a.m. when switching back from daylight saving time.

4.6.2 Periodical sending to a SFTP Server

If in the data export scheduler the sending to an SFTP server was selected as action, the appropriate files will be sent periodically to the SFTP server defined in the settings of the communication.

Host	tenserv.camillebauer.intra
Port	22
Username	sftpuser
Password	copy
Base directory	data
Only connect to trusted host	No

For improving security you may select that the device connects to trusted hosts only. When activating this setting the host must be present and sends a public key back to the device. If you accept this key the associated host will be added to the list of trusted servers.

! If you trust this host, press Yes to add its host key to a cache

Algorithm:ssh-rsa
SHA256:nMMdZ2Ux7aKvlJrJijFZ0kofMUNoONVDUnWyeD7KzSM
MD5:b7:d6:c7:9c:37:ab:c7:8f:6d:e5:90:57:01:b6:8f:6b

Yes No

5. Safety instructions



Death, serious injury or fire hazard could result from improper connection of this instrument. Before connecting the instrument you have to read and understand this manual.

General



Connection of this instrument must be performed in compliance with all applicable national regulations on electricity and any additional safety requirements applicable to your installation.



Observe all valid and applicable safety regulations for work on electrical equipment.



Installation, operation, and maintenance of this instrument must be performed by qualified personnel only. The national regulations for electricity define a qualified person as “one who has the skills and knowledge related to the construction and operation of the electrical equipment and installations, and who has received safety training on the hazards involved.”



Qualified personnel who work on or near exposed energized electrical conductors must follow applicable safety related work practices and procedures including appropriate personal protective equipment in compliance with national standards for electrical safety requirements for employee workplaces and any additional workplace safety requirements applicable to your installation.



It is forbidden to open the device as live parts can be exposed. Any intervention in the device voids the warranty. Maintenance and repair work may only be carried out by our service center.

Before connecting



The instrument must be taken out of service if safe operation is no longer possible (e.g. visible damage). The instrument must be returned to the factory.



Check all test leads and current sensors for insulation defects before use. Replace defective current sensors immediately, voltage test leads can be replaced in the factory only.



Connection and operation of the device must only be carried out by trained personnel, who can recognize the danger of contact and can take the necessary safety precautions. Danger exists everywhere where voltages with a potential of greater than 30V against earth can occur.



Before connecting, make sure the device is switched off. Hint: The instrument is not equipped with an integrated circuit breaker; it is switched on as soon as the power adapter is connected to a live power outlet.



Before connecting, check that the maximum values of all connections of the measurement device are not exceeded.



Current sensors must be connected to the corresponding connectors of the instrument before connecting to the measuring points.



Use in humid ambient conditions is not permitted. The device must not be exposed to moisture.



Before use, check that the device is completely dry, outside and inside. A humid device must not be connected or supplied with auxiliary power.



When determining the place of installation, make sure that the [limits of the operating temperature](#) are not exceeded.

When connecting



If measurements are made which involve a risk of contact, a second person should be present on-site. This is typically the case during the connection of the current and voltage measurement inputs.



De-energize the electrical circuit to be monitored before connecting the test leads and current sensors. You always have to be aware that unforeseen voltages may be present on the test location, for example due to dangerously charged capacitors. Therefore check the absence of voltage and use the necessary protective equipment.



If it is not possible to switch off the system, the general safety instructions given above must be observed. In particular, the wearing of personal protective equipment is mandatory.



Do not touch exposed metal parts of unused voltage test leads.



When using Rogowski coils ACF 2004_1 refer to the operating instructions in [Annex C](#).



When connecting current clamps to live unisolated wires, the clamps may only be touched in the area given below.

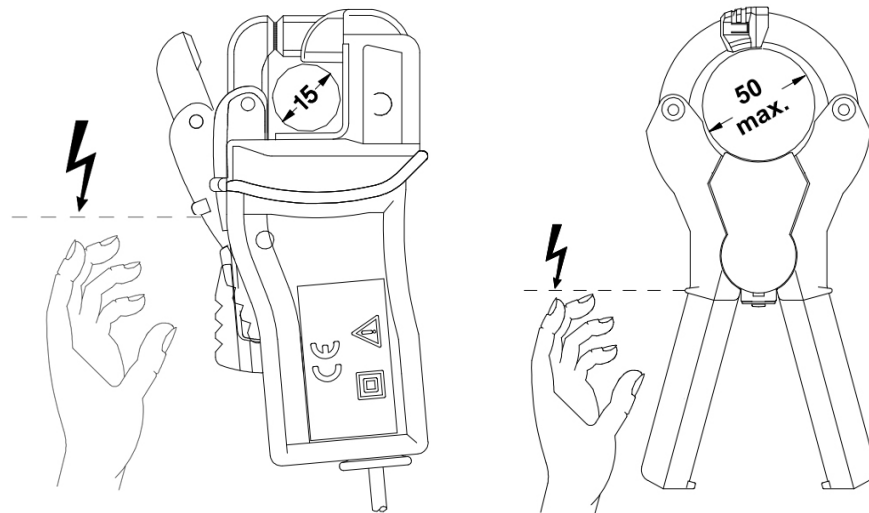

When connecting the test leads and current sensors, pay attention to correct phase sequence and energy direction.



The positive current or energy direction is indicated on the current sensors with an arrow (marked in red for better visibility). This can be found either on the housing or on the nameplate.



6. Electrical connections



Be sure to observe the [Safety instructions](#) in chapter 5!

6.1 Voltage and current inputs

Device variant with current measurement via 4-phase Rogowski probe

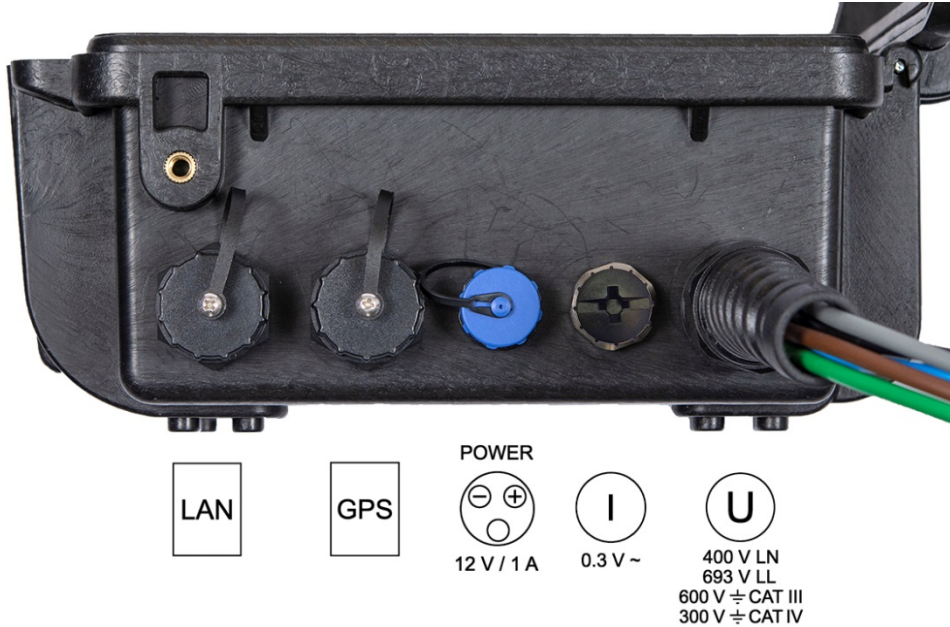

Device variant with current measurement via current clamps xA/1V

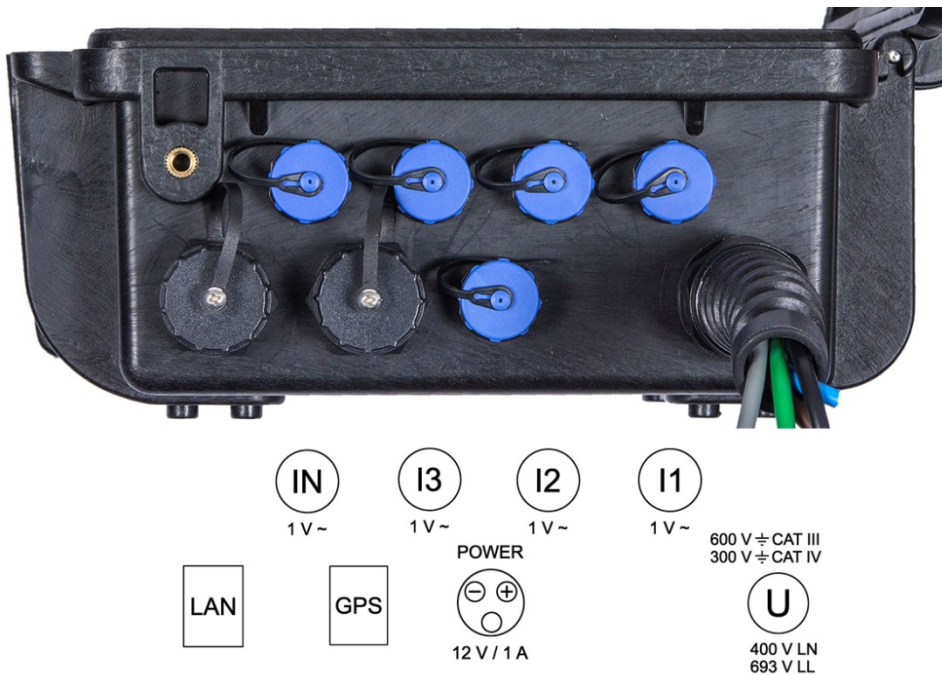

Single-phase AC mains

Current measurement via 4-phase Rogowski probe 2000 A

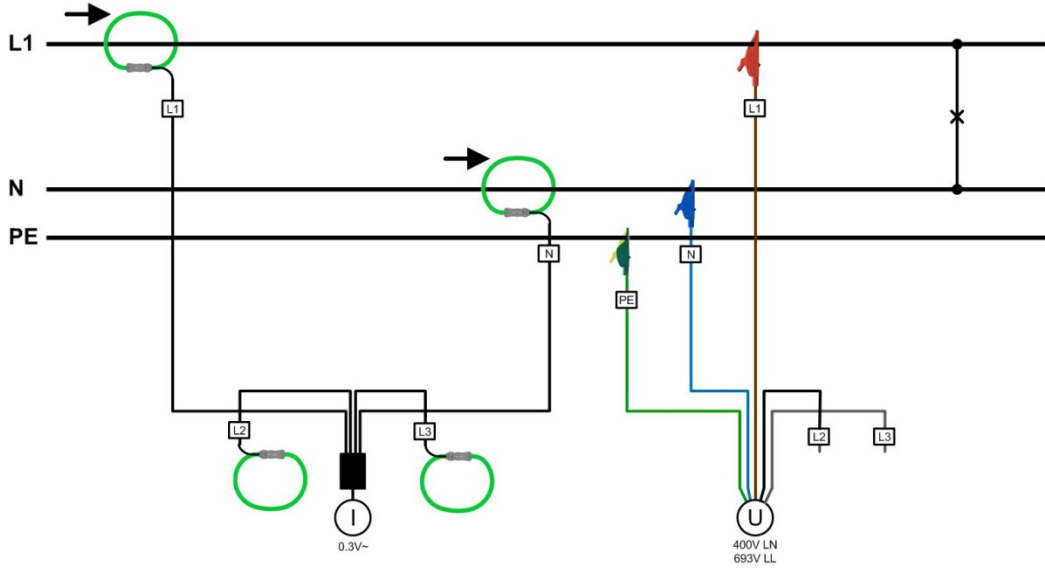

Current measurement via clamps xA/1V

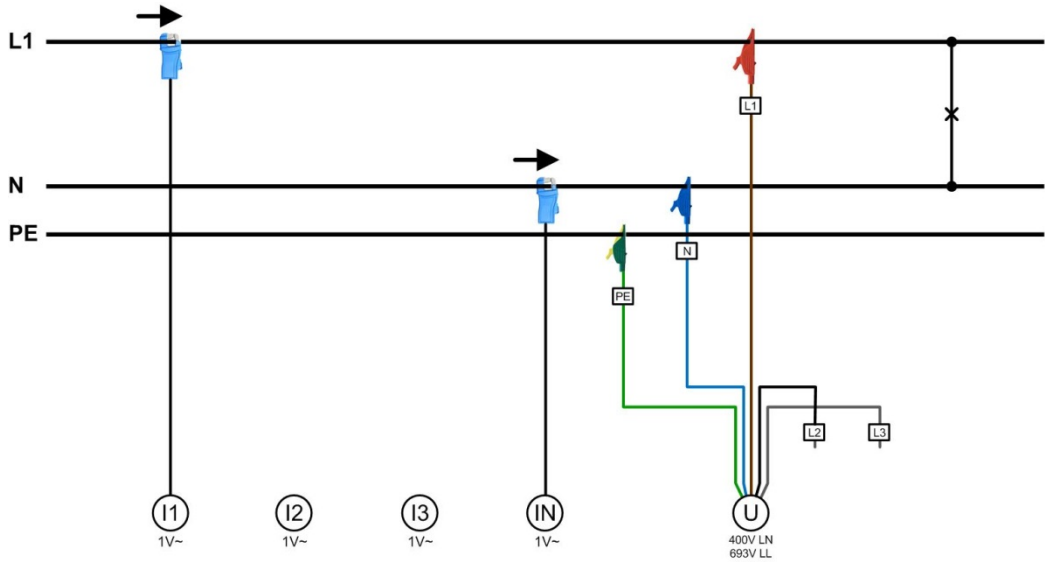

Three wire system, unbalanced load

Current measurement via 4-phase Rogowski probe 2000 A

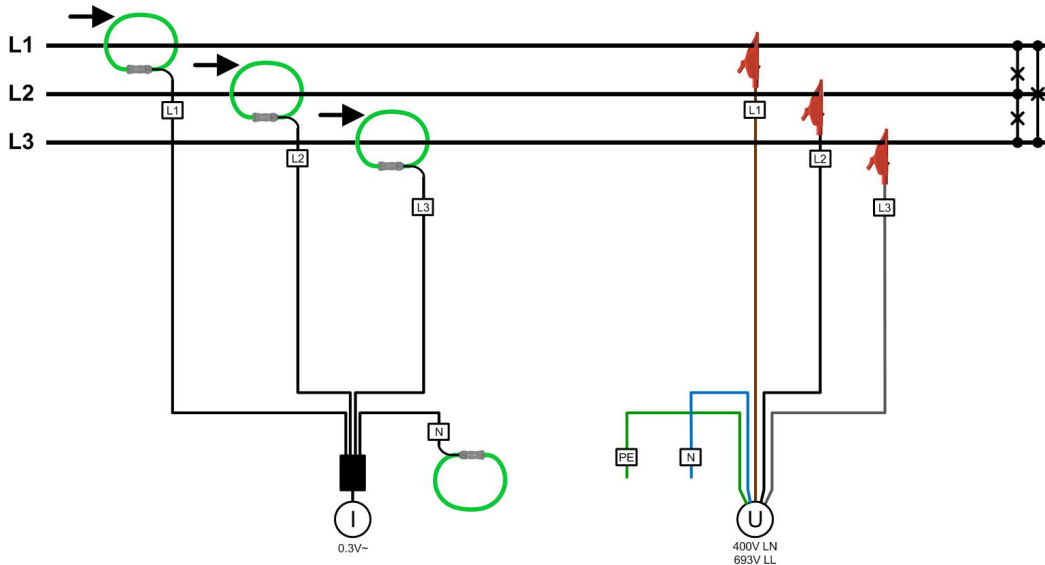

Current measurement via clamps $\times A/1V$

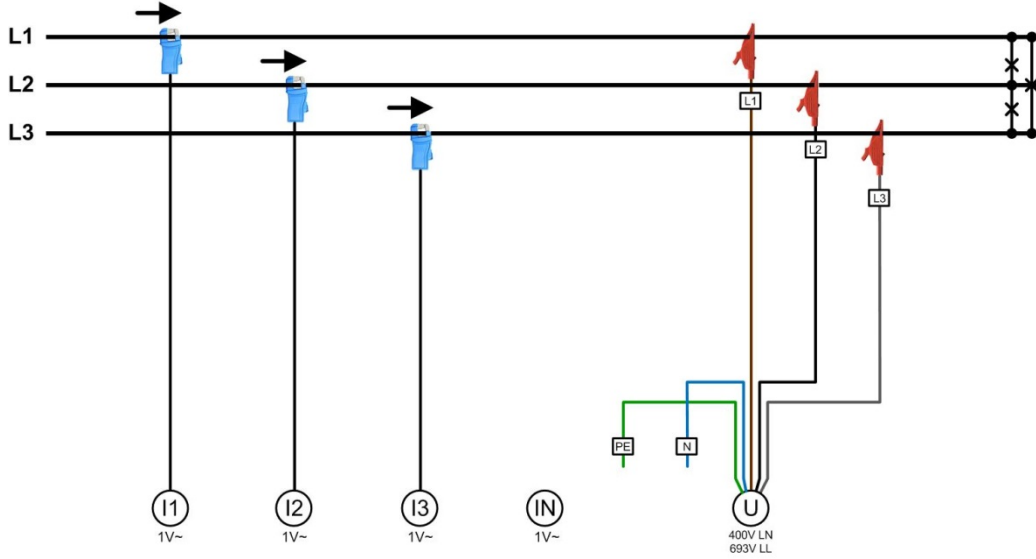

Four wire system, unbalanced load

Current measurement via 4-phase Rogowski probe 2000 A

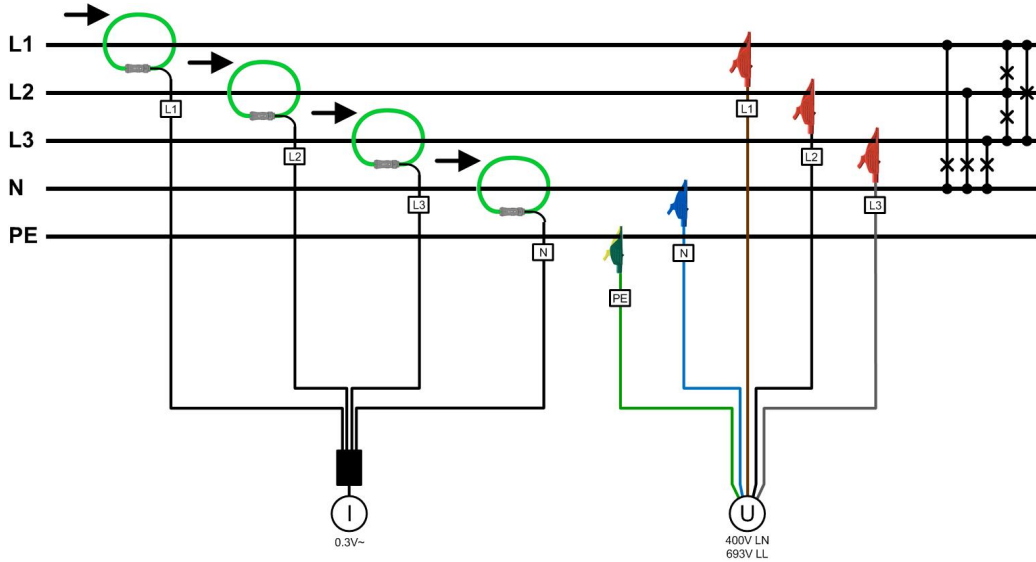

Current measurement via clamps $\times A/1V$

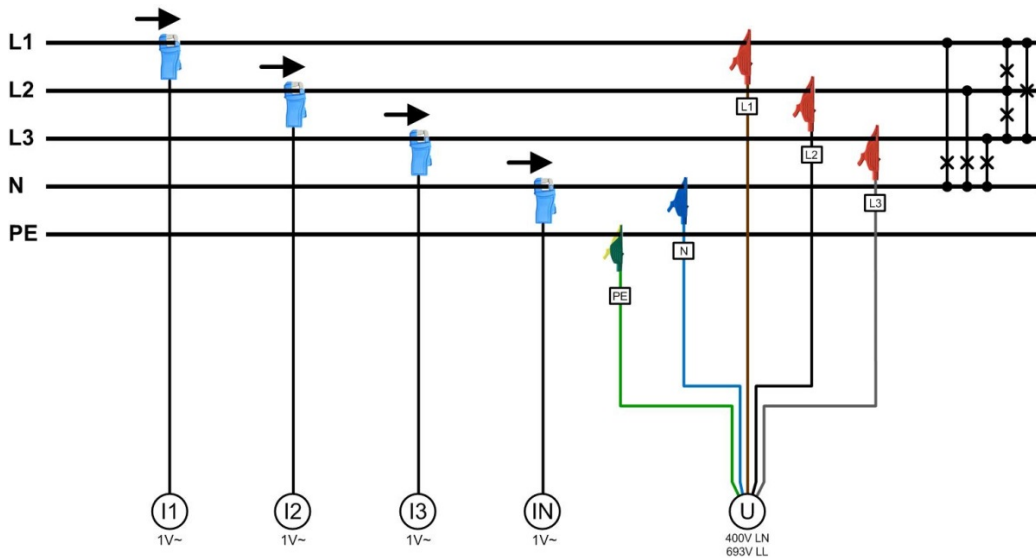

Split-phase ("two phase system"), unbalanced load

Current measurement via 4-phase Rogowski probe 2000 A

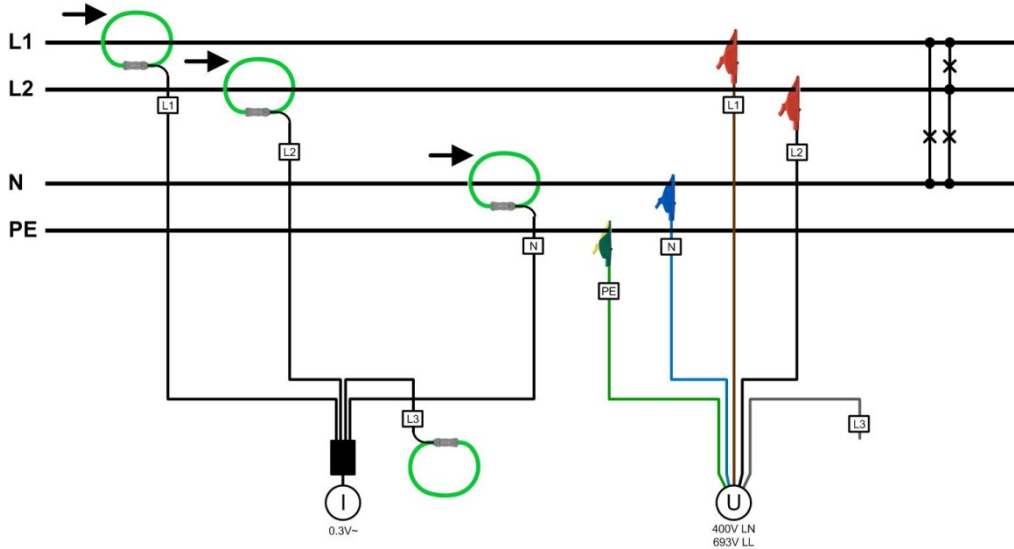

Current measurement via clamps xA/1V

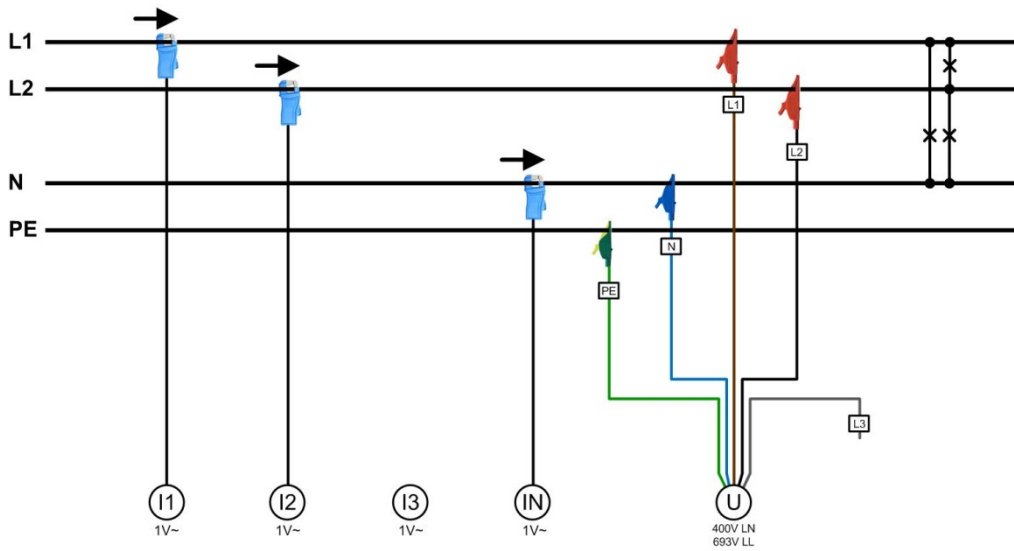

Measurement in the secondary circuit of current transformers

Using current clamps 10A/1V a direct measurement in the secondary circuit of current transformers is possible. In order that measured values are scaled correctly, the current transformer ratio (CT: primary / CT: secondary) in the [configuration of the measurement](#) (4.2.2) must be set accordingly.

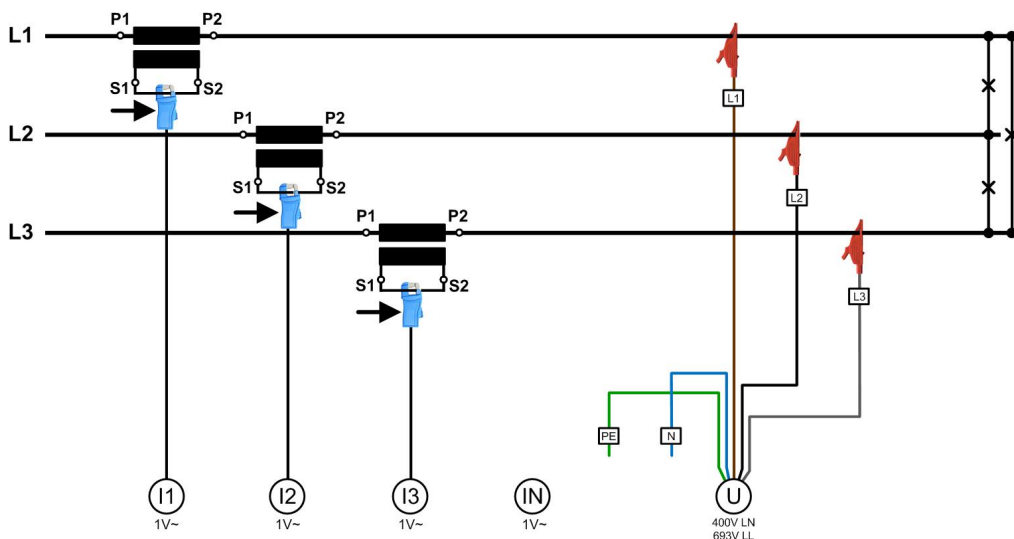

Measurement in the secondary circuit of a voltage transformer

The voltage may be taken from the secondary of a voltage transformer as well. This is shown below on the left.

If a voltage transformer with **extra windings** for measuring the homopolar voltage is applied, connections should be as shown below on the right.

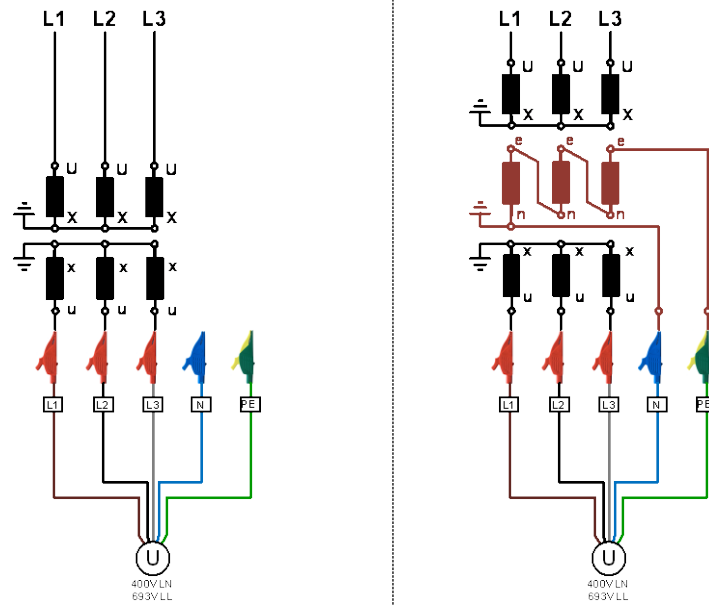

6.2 GPS time synchronization

The optional GPS connection module serves for connecting a GPS receiver as a very accurate time synchronization source for the measurement device. The GPS receiver, available as an accessory, is used as outdoor antenna to process data from multiple GPS satellites simultaneously.

GPS receiver

Only use the receiver **Garmin GPS 16x-LVS** (article no. 181'131), offered as an accessory. This device is preconfigured by us and provides the required time information (sentences) without further configuration effort.

- Protection: IPx7 (waterproof)
- Operating temperature: -30...80°C
- Storage temperature: -40...80°C
- 1Hz pulse accuracy: 1µs
- Connector: RJ45



Choosing a mounting location

For a correct operation the GPS receiver requires data from at least 3 satellites at the same time. Therefore position the receiver so that the clearest possible view of the sky and horizon in all direction is obtained. This can be on the roof of a building, at best without reception being restricted by other buildings or obstacles. Avoid mounting the receiver next to large areas of conductible material, as this may cause poor signal reception. It should be also not closer than 1 meter away from any other antenna.

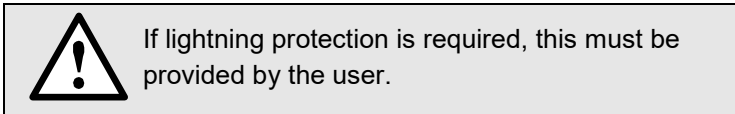

If lightning protection is required, this must be provided by the user.

Mounting the GPS receiver

- The GPS receiver **Garmin GPS 16x-LVS** can be flush mounted by means of 3 M4 screws.
- 120° distribution over a circle of $\varnothing 71.6\text{mm}$
- Thread length max. 8mm. Using longer screws may damage the GPS receiver.

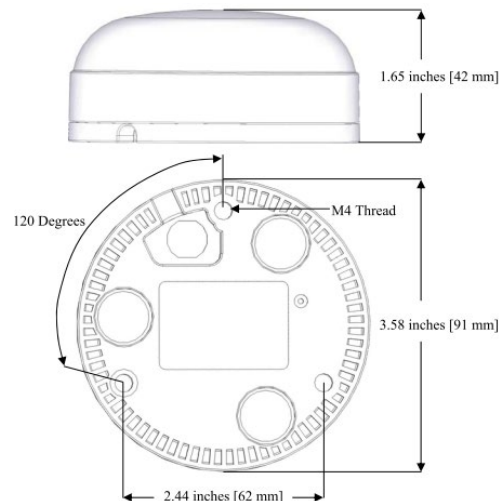

Connecting the GPS receiver



Never connect the RJ45 socket of the connecting cable directly to a network device such as a router or switch. These devices could be damaged.

The GPS receiver is plugged directly into the GPS connection module. The connection cable has a length of 5m. It may be extended to up to 50m using an RJ45 coupling and an Ethernet cable. The connection cable should not be laid in parallel to live conductors. Twisting or sharp kinking of the cable should be avoided.

Commissioning

- In the settings menu change time synchronization to „NTP server / GPS“
- Check the time synchronization status

> Service > Device information > Device state

Min/max values reset	Device version
Meter contents set/reset	Device license
Operating hours	Device state
Device information	
Factory reset	
Firmware update	
Communication Tests	
Device reboot	

```
interFaces -----
1) eth0
MAC:          00:12:34:1A:00:05
State:        Up
Link:         Yes
Speed:        100Mb/s
IP address:   192.168.62.142   [static]
Broadcast addr.: 192.168.63.255 [static]
Subnet mask:  255.255.248.0   [static]
Gateway addr.: 192.168.56.4   [static]

Name servers -----
DNS server 1: 192.168.56.55   [static]

Time sources -----
Source 1:     pool.ntp.org
Source 2:     Local clock
Source 3:     GPS

Time Synchronisation -----
synchronised to GPS at stratum 1
time correct to within 1 ms
polling server every 16 s

GPS Status -----
Number of satellites: 04
GPS quality: Differential fix
```

- The time synchronization can be restarted by switching the time synchronization off and on again.
- Time synchronization via GPS and NTP server may work in parallel. If both synchronization sources are available, the system uses the more accurate time source, which is normally GPS.



When connecting a GPS receiver for the first time or when it has been out of operation for a long time, it may take up to 1 hour for finding enough satellites for GPS receiver operation and thus for a reliable time synchronization.

6.3 Power supply



The instrument is not equipped with an integrated circuit breaker; it is switched on as soon as the power adapter is connected to a live power outlet.



The power adapter must be connected to the device before it is plugged into the power outlet.

7. Commissioning

7.1 Device start



POWER

When the device is powered via the power adapter, the POWER-LED starts flashing. As soon as the POWER LED is permanently ON the startup procedure is finished.

Hint

It is recommended to start the data logging only if ...

- the correct connection of the device has been checked
- the configuration for the present measurement location is complete and correct
- this configuration has been stored and activated in the device
- Measurement data such as min/max values of a previous recording has been reset

Otherwise the device could contain meaningless recordings that complicate the subsequent evaluation and conformity assessment.

7.2 Installation check



The correct connection of the current and voltage inputs can be checked in two ways.

- a) **Sense of rotation check:** Using the sequence of the current and voltage phasors the sense of rotation is determined and compared to the configured one. The phase rotation indicator is arranged in the menu "Phasor diagram".

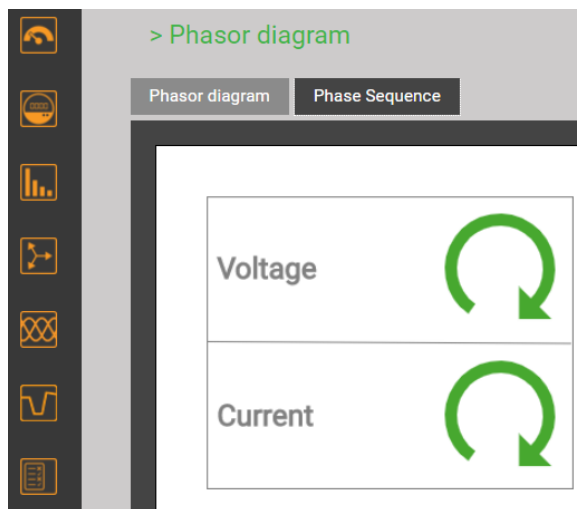
Test requirement: Magnitude of all connected voltages at least 5% of nominal, magnitude of all connected currents at least 0.2% of nominal.







Possible results

-  Correct sense of rotation
-  Wrong sense of rotation
-  Missing phase or magnitude too small

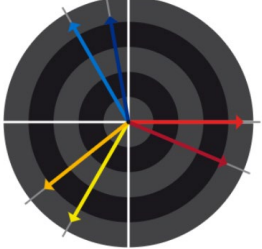
b) **Phasor verification:** The phasor diagram shows a technical visualization of the current and voltage phasors, using a counter-clockwise rotation, independent of the real sense of rotation.

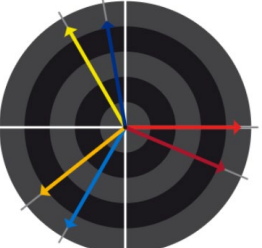
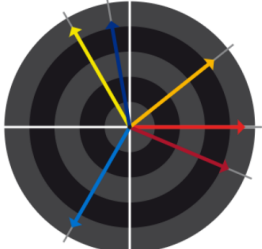
 **The diagram is always built basing on the voltage of the reference channel (direction 3 o'clock)**

 <p>50V/div 20A/div</p>	<table border="1"> <thead> <tr> <th>L1</th> <th>L2</th> <th>L3</th> <th></th> </tr> </thead> <tbody> <tr> <td>230.60</td> <td>230.64</td> <td>230.54</td> <td>V</td> </tr> <tr> <td>0.00</td> <td>-119.97</td> <td>120.03</td> <td>*</td> </tr> <tr> <td>85.97</td> <td>86.03</td> <td>85.86</td> <td>A</td> </tr> <tr> <td>-22.9</td> <td>-21.7</td> <td>-20.0</td> <td>*</td> </tr> <tr> <td>0.921</td> <td>0.929</td> <td>0.940</td> <td>PF</td> </tr> </tbody> </table>	L1	L2	L3		230.60	230.64	230.54	V	0.00	-119.97	120.03	*	85.97	86.03	85.86	A	-22.9	-21.7	-20.0	*	0.921	0.929	0.940	PF	<p>Correct installation (expectation)</p> <ul style="list-style-type: none"> • Voltage sequence in clock-wise order L1 → L2 → L3 ($0^\circ \rightarrow -120^\circ \rightarrow 120^\circ$) • Current sequence in clock-wise order L1 → L2 → L3 • Similar angle between voltage and current phasors in all phases (approx. -20°)
L1	L2	L3																								
230.60	230.64	230.54	V																							
0.00	-119.97	120.03	*																							
85.97	86.03	85.86	A																							
-22.9	-21.7	-20.0	*																							
0.921	0.929	0.940	PF																							
 <p>50V/div 20A/div</p>	<table border="1"> <thead> <tr> <th>L1</th> <th>L2</th> <th>L3</th> <th></th> </tr> </thead> <tbody> <tr> <td>230.58</td> <td>230.63</td> <td>230.53</td> <td>V</td> </tr> <tr> <td>0.00</td> <td>-119.97</td> <td>120.03</td> <td>*</td> </tr> <tr> <td>85.96</td> <td>86.04</td> <td>85.87</td> <td>A</td> </tr> <tr> <td>-22.9</td> <td>158.4</td> <td>-20.0</td> <td>*</td> </tr> <tr> <td>0.921</td> <td>-0.930</td> <td>0.940</td> <td>PF</td> </tr> </tbody> </table>	L1	L2	L3		230.58	230.63	230.53	V	0.00	-119.97	120.03	*	85.96	86.04	85.87	A	-22.9	158.4	-20.0	*	0.921	-0.930	0.940	PF	<p>What's wrong?</p> <ul style="list-style-type: none"> • Voltage sequence: L1 → L2 → L3 • Current sequence: L1 → L3 → L2; Current L2 is out of the expected sequence • Angle U-I: Angle between U_{L2} and I_{L2} is approx. 180° wrong <p>Required correction Reversing the polarity of current I_2</p>
L1	L2	L3																								
230.58	230.63	230.53	V																							
0.00	-119.97	120.03	*																							
85.96	86.04	85.87	A																							
-22.9	158.4	-20.0	*																							
0.921	-0.930	0.940	PF																							
 <p>50V/div 20A/div</p>	<table border="1"> <thead> <tr> <th>L1</th> <th>L2</th> <th>L3</th> <th></th> </tr> </thead> <tbody> <tr> <td>230.59</td> <td>230.49</td> <td>230.70</td> <td>V</td> </tr> <tr> <td>0.00</td> <td>120.04</td> <td>-119.99</td> <td>*</td> </tr> <tr> <td>85.97</td> <td>86.02</td> <td>85.86</td> <td>A</td> </tr> <tr> <td>-22.9</td> <td>98.3</td> <td>-140.0</td> <td>*</td> </tr> <tr> <td>0.921</td> <td>-0.145</td> <td>-0.766</td> <td>PF</td> </tr> </tbody> </table>	L1	L2	L3		230.59	230.49	230.70	V	0.00	120.04	-119.99	*	85.97	86.02	85.86	A	-22.9	98.3	-140.0	*	0.921	-0.145	-0.766	PF	<p>What's wrong?</p> <ul style="list-style-type: none"> • Voltage sequence: L1 → L3 → L2; L3 and L2 seem to be interchanged • Current sequence: L1 → L2 → L3 • Angle U-I: Angles between U_{L2} / I_{L2} and U_{L3} / I_{L3} do not correspond to the expectations <p>Required correction Exchanging the connections of the voltages L2 and L3</p>
L1	L2	L3																								
230.59	230.49	230.70	V																							
0.00	120.04	-119.99	*																							
85.97	86.02	85.86	A																							
-22.9	98.3	-140.0	*																							
0.921	-0.145	-0.766	PF																							
 <p>50V/div 20A/div</p>	<table border="1"> <thead> <tr> <th>L1</th> <th>L2</th> <th>L3</th> <th></th> </tr> </thead> <tbody> <tr> <td>230.58</td> <td>230.49</td> <td>230.68</td> <td>V</td> </tr> <tr> <td>0.00</td> <td>120.04</td> <td>-119.99</td> <td>*</td> </tr> <tr> <td>85.97</td> <td>86.04</td> <td>85.86</td> <td>A</td> </tr> <tr> <td>-22.9</td> <td>-81.6</td> <td>-140.0</td> <td>*</td> </tr> <tr> <td>0.921</td> <td>0.145</td> <td>-0.766</td> <td>PF</td> </tr> </tbody> </table>	L1	L2	L3		230.58	230.49	230.68	V	0.00	120.04	-119.99	*	85.97	86.04	85.86	A	-22.9	-81.6	-140.0	*	0.921	0.145	-0.766	PF	<p>What's wrong?</p> <ul style="list-style-type: none"> • Voltage sequence: L1 → L3 → L2; L3 and L2 seems to be exchanged • Current sequence: L1 → L3 → L2; Current L2 is out of the expected sequence • Angle U-I: Angles between U_{L2} / I_{L2} and U_{L3} / I_{L3} do not correspond to the expectations <p>Required correction Exchanging the connections of the voltages L2 and L3 and reversing the polarity of the current input I_2</p>
L1	L2	L3																								
230.58	230.49	230.68	V																							
0.00	120.04	-119.99	*																							
85.97	86.04	85.86	A																							
-22.9	-81.6	-140.0	*																							
0.921	0.145	-0.766	PF																							
 <p>50V/div 20A/div</p>	<table border="1"> <thead> <tr> <th>L1</th> <th>L2</th> <th>L3</th> <th></th> </tr> </thead> <tbody> <tr> <td>230.45</td> <td>230.48</td> <td>230.58</td> <td>V</td> </tr> <tr> <td>0.00</td> <td>-120.02</td> <td>119.98</td> <td>*</td> </tr> <tr> <td>85.96</td> <td>86.00</td> <td>85.86</td> <td>A</td> </tr> <tr> <td>-143.0</td> <td>-141.6</td> <td>-140.0</td> <td>*</td> </tr> <tr> <td>-0.798</td> <td>-0.784</td> <td>-0.766</td> <td>PF</td> </tr> </tbody> </table>	L1	L2	L3		230.45	230.48	230.58	V	0.00	-120.02	119.98	*	85.96	86.00	85.86	A	-143.0	-141.6	-140.0	*	-0.798	-0.784	-0.766	PF	<p>What's wrong?</p> <ul style="list-style-type: none"> • Voltage sequence: L1 → L2 → L3 • Current sequence: L3 → L1 → L2 • Angle U-I: The U-I angles do not correspond to the expectation, but are similar <p>Required correction Cyclical exchange of the voltage connections: $L1 \rightarrow L3, L2 \rightarrow L1, L3 \rightarrow L2$. As an alternative the sequence of all currents may be changed as well (more effort required).</p>
L1	L2	L3																								
230.45	230.48	230.58	V																							
0.00	-120.02	119.98	*																							
85.96	86.00	85.86	A																							
-143.0	-141.6	-140.0	*																							
-0.798	-0.784	-0.766	PF																							

7.3 Measurement data reset

- **Minimum and maximum values** may be reset in groups via the service menu:

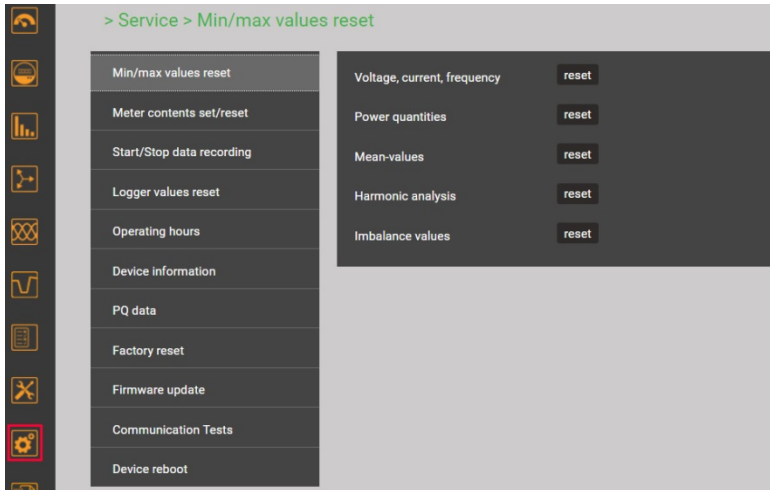

Group	Values to be reset
1	Min/max values of voltages, currents and frequency
2	Min/max values of Power quantities (P,Q,Q(H1),D,S); min. load factors
3	Min/max values of power mean-values, bimetal slave pointers and free selectable mean-values
4	Maximum values of harmonic analysis: THD U/I, TDD I, individual harmonics U/I
5	All imbalance maximum values of voltage and current

- **Meter contents** may be individually set or reset during operation using the service menu.
- **Recorded logger data** can be individually reset via the service menu.

 **When deleting logger data, always the complete content of the selected group is deleted, it is not differentiated according to configurations.**

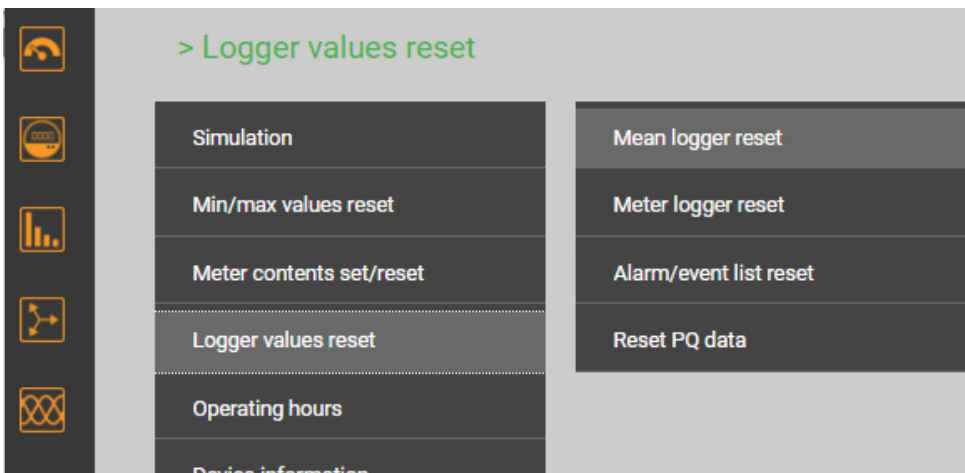

7.4 Start data recording

The data recording can be started directly at the device or via the website.



RECORD

Using the button RECORD recording can be started and stopped. If the associated LED is ON, recording is started.

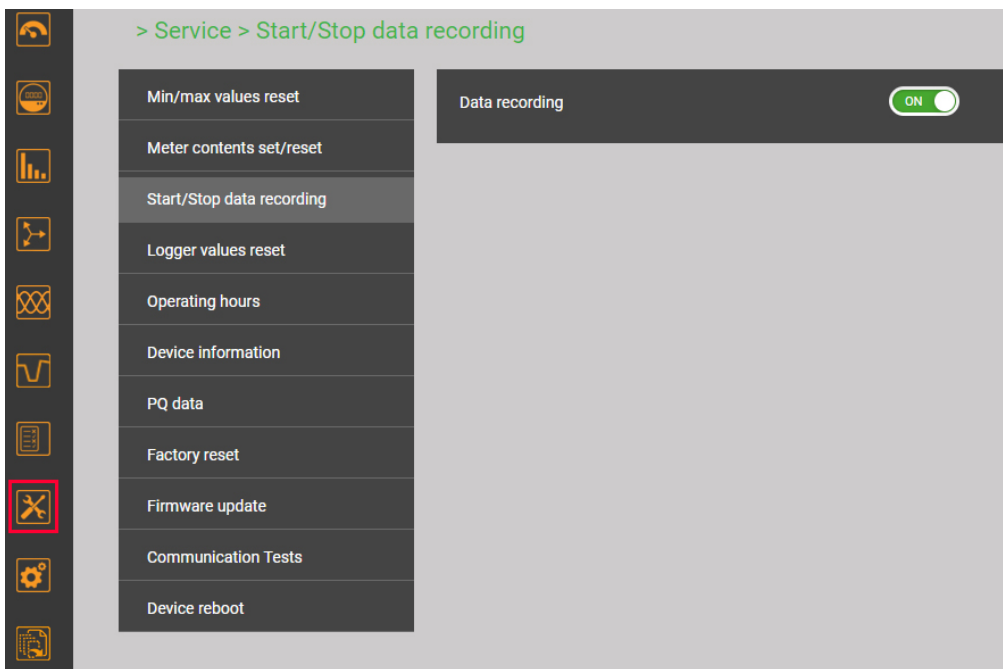

Start / Stop of data recording via the service menu

The state of the data recording is displayed in the status bar

Data recording	Status bar
Started	
Stopped	

Tip: By selecting the status symbol you can go directly to the corresponding menu

8. Evaluation of recorded data



For the evaluation of recorded data you first have to activate the configuration used during data recording. Only data recorded with the active configuration will be shown.

ATTENTION: If the configuration used during data recording has been changed or is no longer available, an evaluation of the data may no longer be possible.

8.1 Available long-term recordings

Via Configuration manager the recorded time ranges for each configuration may be displayed:

The screenshot shows the Configuration manager interface. At the top, there is a dropdown menu for configuration selection, currently set to "[17] Hauptteilspeisung GB2 UG2, Aargauerstr. 7, Wohnen". Below this, there is a header for the configuration: "Hauptteilspeisung GB2 UG2, Aargauerstr. 7, Wohnen" with technical specifications: "4W unbalanced, 230.0V, 100A, 50Hz". There are three buttons: "Activate configuration", "Delete", and "Download". Below the buttons, there is a table titled "Config [17] Survey" with the following data:

Start Time	End Time
13.03.2020, 10:21:53	?
11.03.2020, 16:59:27	13.03.2020, 09:44:44
04.03.2020, 15:53:19	11.03.2020, 16:45:56
25.02.2020, 12:57:12	04.03.2020, 15:52:56
20.01.2020, 15:56:14	21.02.2020, 13:26:58
02.12.2019, 16:21:02	20.01.2020, 15:56:12
23.09.2019, 13:40:51	02.12.2019, 10:35:59
04.09.2019, 15:28:40	23.09.2019, 13:27:13

Group	Data type	Request
Periodic data	<ul style="list-style-type: none"> • Mean-values versus time, predefined (5) and user-specific (12) quantities • Periodic meter readings, predefined (4) and user-specific (12) quantities 	<p>Energy</p> <ul style="list-style-type: none"> • Mean value logger • Meter logger
Events	<p>In form of a logbook with time information:</p> <ul style="list-style-type: none"> • Event list: Every state transition of monitoring functions or limit values, classified as event • Alarm list: Every state transition of monitoring functions or limit values, classified as alarm 	<p>Events</p> <ul style="list-style-type: none"> • Event and alarm list
Security events	<ul style="list-style-type: none"> • Security log (SYSLOG) 	<p>Service</p> <ul style="list-style-type: none"> • Log of the security system
PQ events	<p>The occurrence of PQ events will be registered in the PQ event list. By selecting the entries for voltage events:</p> <ul style="list-style-type: none"> • the course of the RMS values of all U/I • the wave shape of all U/I <p>during the disturbance will be displayed</p>	<p>Events</p> <ul style="list-style-type: none"> • PQ events and Mains Signalling
PQ statistic	<p>For a selectable weekly interval the evaluation of the PQ statistic is displayed, depending on the selected standard.</p> <p>In addition, daily trends of the monitored PQ variables can be displayed.</p> <p>By means of PQ-Easy Report, conformity reports can be created directly via website.</p>	

Data export as CSV file



With the exception of the PQ statistic data, all information shown above can be exported as CSV file (Comma Separated Value).

Download data

Time domain

Start: 7.6.2016

End: 14.6.2016

Download Cancel

For courses of measurement (e.g. mean values) the time range of the data to export can be selected. For event lists the last 250 events are stored.

The created CSV file can be imported as a text file to Excel, with comma as a separator.

Data for all quantities of the corresponding group are stored in the same file.

8.1.1 Periodic data

Displaying the chronology of the mean values

The chronology of the mean values is available via the menu **Energy** and is divided in two groups:

- Pre-defined power mean values
- User-defined mean values

Power mean values can easily be converted into energy values:

$$\text{Energy} = \text{Averaging_interval} * \text{Power_mean_value}$$

By summing these individual values, energy consumption can be calculated with high resolution. This can be done very easily via the exported CSV data in Excel.

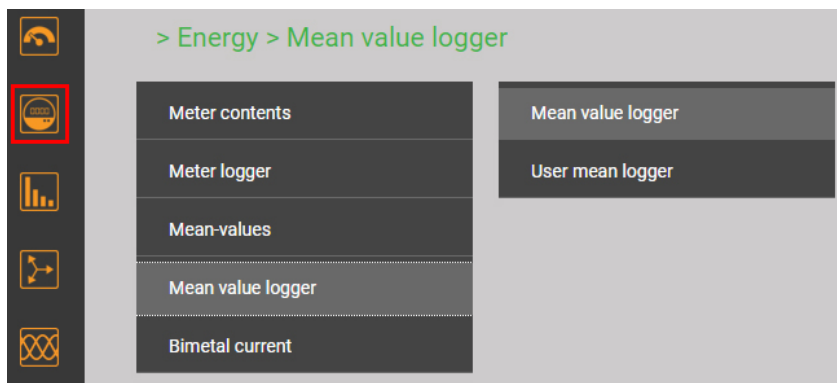

Selection of the mean value group



The selection of the mean-value quantity to display can be performed via choosing the corresponding register. Three different kind of displays are supported:

- Daily profile: Hourly mean-values will be shown, independently of the real averaging time
- Weekly profile
- Table: Listing of all acquired mean-values in the sequence of the real averaging interval

The graphical representation allows comparing directly the values of the previous day respectively week.



By selecting the bars you may read the associated values:

- Mean-value
- Min. RMS value within the interval
- Max. RMS value within the interval



Weekly display



Weekly display: Reading

> Mean value logger

Log P (I+IV) | Log P (II+III) | Log Q (II) | Log Q (III+IV) | Log S

Day Week Table

«Previous 1 2 3 4 5 Next» Results per page 25

#	time	mean	min(interval)	max(interval)
1	14.06.2016, 14.33.00.000	78.89 kW	65.75 kW	109.42 kW
2	14.06.2016, 14.32.00.000	93.65 kW	74.96 kW	125.97 kW
3	14.06.2016, 14.31.00.000	86.42 kW	74.48 kW	104.69 kW
4	14.06.2016, 14.30.00.000	80.17 kW	67.36 kW	106.59 kW
5	14.06.2016, 14.29.00.000	88.62 kW	75.01 kW	111.77 kW
6	14.06.2016, 14.28.00.000	80.96 kW	69.96 kW	116.12 kW
7	14.06.2016, 14.27.00.000	81.96 kW	68.81 kW	108.47 kW
8	14.06.2016, 14.26.00.000	80.98 kW	69.05 kW	102.54 kW
9	14.06.2016, 14.25.00.000	88.52 kW	68.12 kW	123.43 kW
10	14.06.2016, 14.24.00.000	87.26 kW	70.46 kW	104.98 kW

Mean values in table format

Displaying the chronology of meter contents

The chronology of meters is available via the menu **Energy** and is divided in two groups:

- Pre-defined meters
- User-defined meters

From the difference of two successive meter readings the energy consumption for the dedicated time range can be determined.

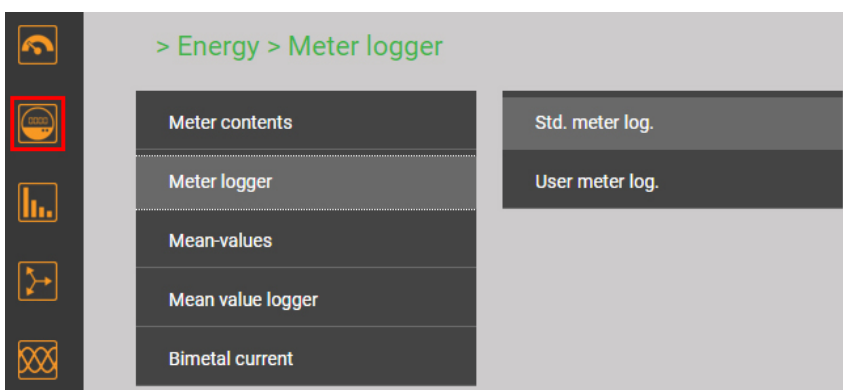

Selection of the meter logger group

> Std. meter log.

Log. ΣP(I+IV) Log. ΣP(I+III) Log. ΣQ(I+II) Log. ΣQ(III+IV)

«Previous 1 2 3 4 5 Next» Results per page 25

#	time	ΣP(I+IV), ΣIT	ΣP(I+IV), ΣHT
1	15.06.2016, 14:00:00.000	0 kWh	33276.80 kWh
2	15.06.2016, 13:00:00.000	0 kWh	33203.10 kWh
3	15.06.2016, 12:00:00.000	0 kWh	33137.40 kWh
4	15.06.2016, 11:00:00.000	0 kWh	33069.10 kWh
5	15.06.2016, 10:00:00.000	0 kWh	32996 kWh
6	15.06.2016, 09:00:00.000	0 kWh	32919.70 kWh
7	15.06.2016, 08:00:00.000	0 kWh	32849.90 kWh
8	15.06.2016, 07:00:00.000	0 kWh	32784 kWh
9	15.06.2016, 06:00:00.000	0 kWh	32735.30 kWh
10	15.06.2016, 05:00:00.000	0 kWh	32719.10 kWh
11	15.06.2016, 04:00:00.000	0 kWh	32687.10 kWh

Meter content readings in table form

8.1.2 Events

Event lists are a kind of logbook. The occurrence of monitored events is recorded in the appropriate list with the time of its occurrence. There are the following lists:

- Alarm and event list (based on [user-defined monitorings](#), chap. 4.2)
- [PQ events](#) (8.1.3)
- [Security log](#) (8.3.5) via Service menu

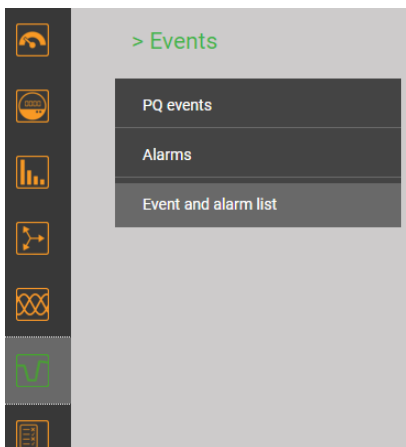

> Event and alarm list

Event list Alarm list

«K < 1 2 3 4 5 > +5» Results per page 25

#	time	text	state
1	25.11.2019, 18:30:36,097	U1N high	┌
2	25.11.2019, 18:16:27,154	U1N high	└
3	25.11.2019, 18:16:03,609	U1N high	┌
4	25.11.2019, 17:46:56,066	U1N high	└
5	21.11.2019, 14:15:16,453	U1N high	┌
6	21.11.2019, 14:15:09,055	U1N high	└
7	21.11.2019, 14:07:40,319	U1N high	┌

Example of an event list

8.1.3 PQ events

Recorded events are available in the form of a logbook, mains signalling events are stored in a separated list. Each detected event is entered into the PQ event list with the time of its occurrence, the remaining voltage and the duration of the event. By selecting a list entry the graphical display of the measured values during this event is entered. The following presentations are available:

- Half cycle RMS curves of all voltages, all currents, all voltages and currents
- Curve shapes of all voltages, all currents, all voltages and currents

> PQ events

PQ events Mains Signalling

Navigation: < 1 2 3 4 5 > +5>> Results per page: 25

#	time	Trigger channel	Event type	Event value	Event value	Duration [s]
51	22.11.2018, 06:04:54,061	U1	Voltage dip	Residual voltage: 177.59 V	Depth: 52.41 V	0.070
52	15.11.2018, 06:19:34,599	U1, U3	Rapid voltage change	ΔU_{max} : 30.34 V	ΔU_{ss} : 0.08 V	0.093
53	30.10.2018, 01:32:59,765	U3	Rapid voltage change	ΔU_{max} : 13.78 V	ΔU_{ss} : 0.12 V	0.340
54	30.10.2018, 01:31:01,378	U2	Rapid voltage change	ΔU_{max} : 19.83 V	ΔU_{ss} : 0.32 V	0.070
55	30.10.2018, 01:29:14,032	U3	Rapid voltage change	ΔU_{max} : 21.22 V	ΔU_{ss} : 0.60 V	0.650
56	29.10.2018, 20:06:17,128	U1, U2, U3	Rapid voltage change	ΔU_{max} : 23.78 V	ΔU_{ss} : 0.95 V	0.117
57	28.10.2018, 06:04:04,247	U1	Rapid voltage change	ΔU_{max} : 18.62 V	ΔU_{ss} : 0.14 V	0.060
58	25.10.2018, 15:57:16,387	U3	Voltage dip	Residual voltage: 187.26 V	Depth: 42.74 V	0.040
59	25.10.2018, 13:25:06,893	U1, U2	Rapid voltage change	ΔU_{max} : 19.32 V	ΔU_{ss} : 0.18 V	0.027

List of PQ events



Graphical display of a PQ event (RMS 1/2)

The recorded data in the mains signalling area allow checking, if the magnitude of the ripple control signal at the receiver complies with the expectations and if the pulse sequences arrive correctly.

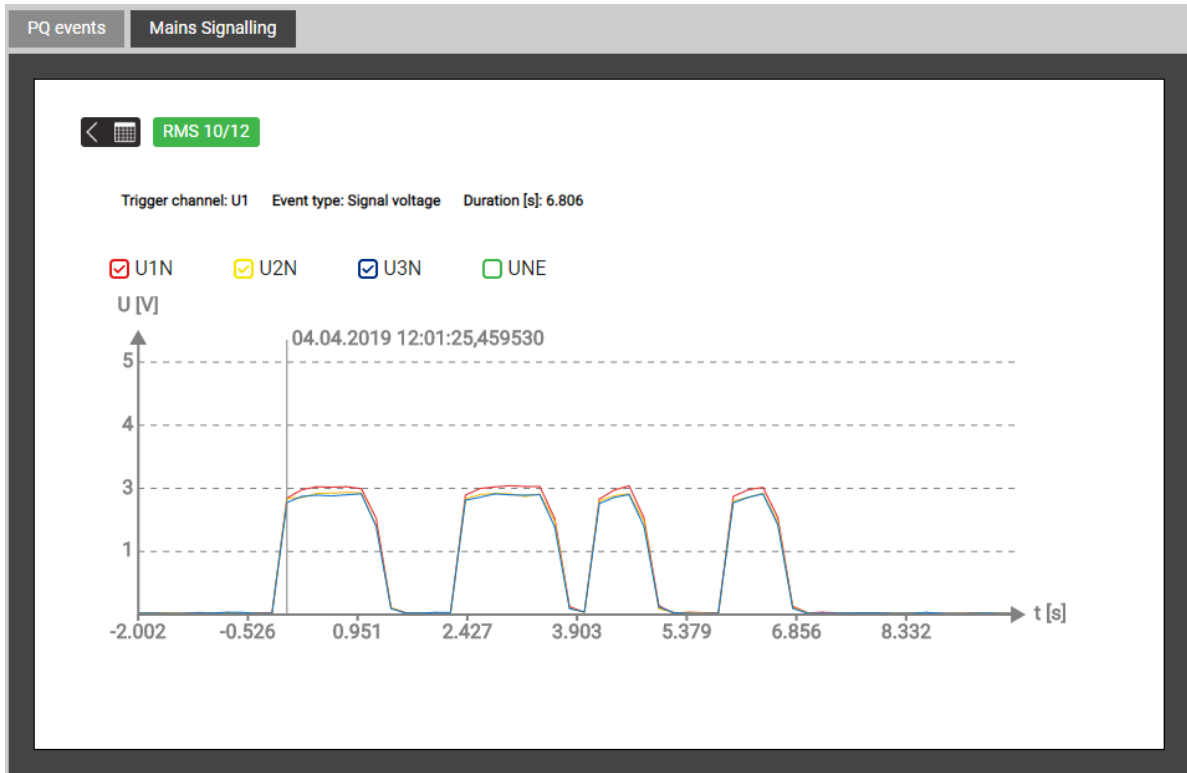

Recognized sequence on the ripple control frequency

8.1.4 PQ statistic

Via the menu PQ statistic all recorded power quality data can be visualized and assessed.

- PQ statistic overview of the [monitored criteria](#) (4.4.2)
- Daily trends of the recorded PQ variables
- PQ-Easy compliance report

PQ statistic overview

The overview is loaded and displayed for the duration of the selected survey period, applying the selected standard. From that it is very easy to see whether the limits of the monitored criteria are respected or not. Each criterion to be monitored by the selected standard is represented by a bar, which itself may be composed of multiple color components:

- Requirement fulfilled**
- Missing data**
- Requirement not fulfilled**

Example for monitoring voltage variations:

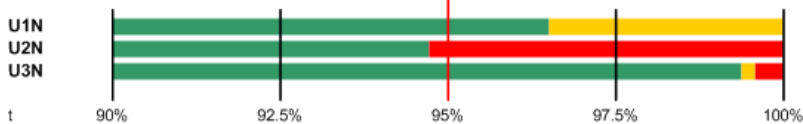

- Limit to be respected is marked with a red line (95% of the time range)
- U1N: Requirement fulfilled, because green bar > 95%
- U2N: Requirement not fulfilled, because green bar < 95%
- U3N: Requirement fulfilled, because green bar > 95%

> PQ statistic

Overview
Frequency
Daily statistic voltage
Harmonics U
Interharmonic U
Daily statistic current

Harmonics I
Interharmonics I

Survey: 14.07.2020 - 17.07.2020 Standard: EN50160

LV

Frequency

	<div style="display: flex; align-items: center;"> <div style="width: 95%; height: 10px; background-color: green;"></div> <div style="width: 5%; height: 10px; background-color: yellow;"></div> </div>	
t	95.0% 96.3% 97.5% 98.8% 100.0%	

Voltage

	<div style="display: flex; align-items: center;"> <div style="width: 95%; height: 10px; background-color: green;"></div> <div style="width: 5%; height: 10px; background-color: yellow;"></div> </div>	
t	90.0% 92.5% 95.0% 97.5% 100.0%	

Long-term Flicker PIt

	<div style="display: flex; align-items: center;"> <div style="width: 95%; height: 10px; background-color: green;"></div> <div style="width: 5%; height: 10px; background-color: yellow;"></div> </div>	
t	90.0% 92.5% 95.0% 97.5% 100.0%	

Mains Signalling Voltage

	<div style="display: flex; align-items: center;"> <div style="width: 95%; height: 10px; background-color: green;"></div> <div style="width: 5%; height: 10px; background-color: yellow;"></div> </div>	
t	95.0% 96.3% 97.5% 98.8% 100.0%	

Voltage imbalance

	<div style="display: flex; align-items: center;"> <div style="width: 95%; height: 10px; background-color: green;"></div> <div style="width: 5%; height: 10px; background-color: yellow;"></div> </div>	
t	90.0% 92.5% 95.0% 97.5% 100.0%	

The PQ statistic overview is shown for the duration of the selected campaign, with the end time being reduced to the last full 10-min interval.

Daily trends of monitored PQ variables

For all recorded PQ variables details can be displayed on daily basis. As far as the selected standard defines limits for the visualized quantity, these will be inserted in the graphic. Some examples are shown below:



Voltage harmonics

For each phase and each harmonic it is shown, how close the determined values are to the **limit value**.

For each value the **mean value** of the 144 daily values and the **maximum** 10-min value is displayed.

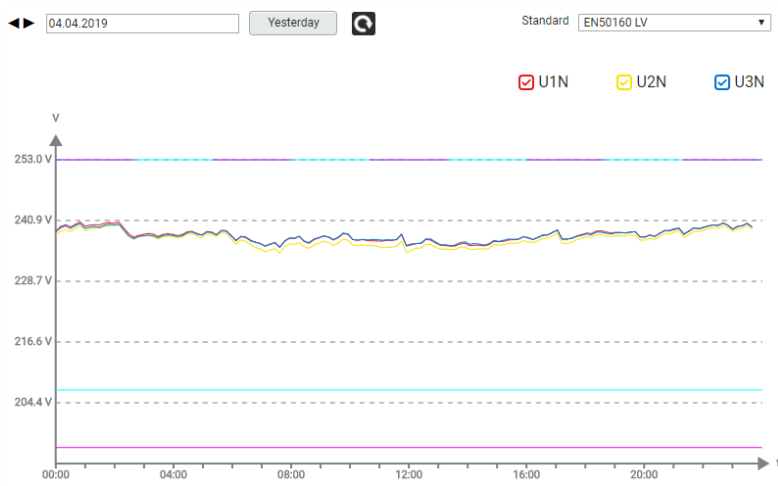

Voltage trends

For each individual voltage the daily trend of the 10-min values is shown.

For the selected standard the following ranges may not be left:

- for 100% of time ($\pm 10\%$)
- for 95% of time (+10 / -15%)

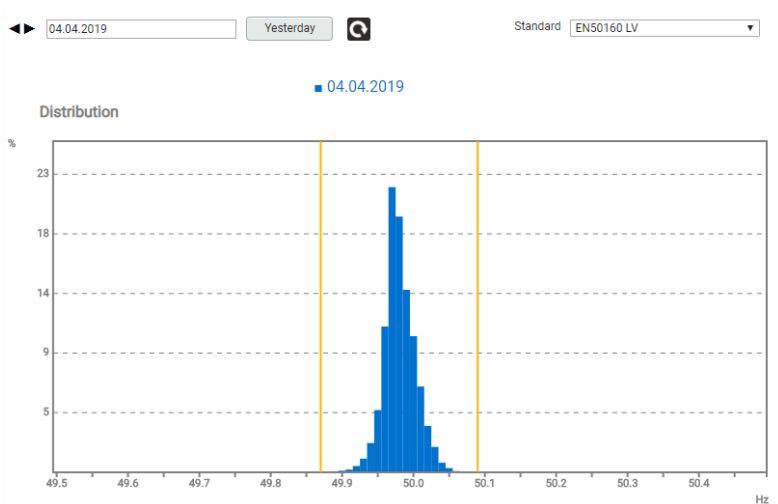

Distribution of 10-s frequency values

The **lines** mark the detected minimum and maximum frequency values.

The limit values are here not visible, because they are outside of the displayed range.

8.1.5 PQ-Easy compliance report

Via  a compliance report in PDF format can be created.

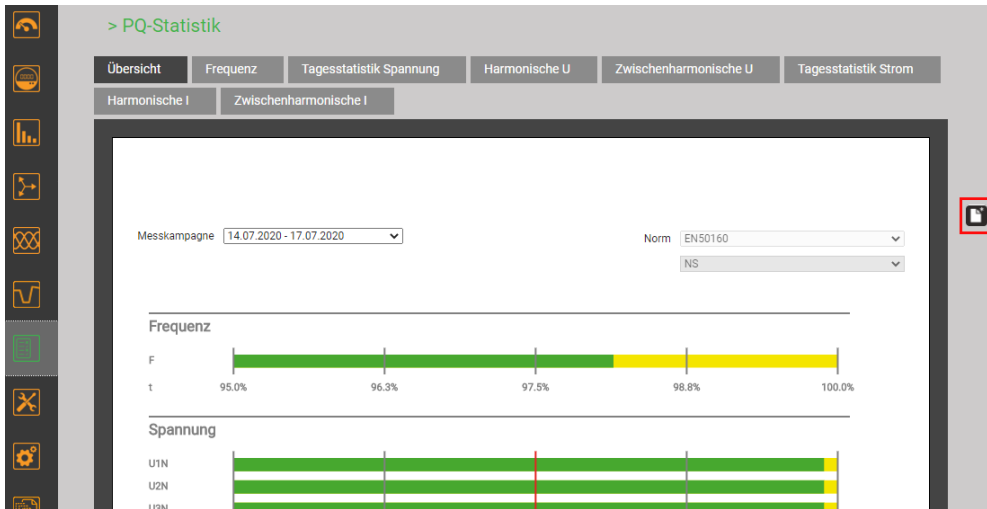

1. Select survey. Hint: Start and end time are reduced to 10-min intervals.
2. Start and end time may be modified in 10-min steps.
3. Select content of report (3 levels)
4. Enter a comment, which needs to be shown on the first page of the report
5. Start report generation...

During report generation a progress bar is shown at the upper side of the screen. The duration of the report generation depends on the selected content, the assessment period and the number of recorded PQ events.

The generated report can be downloaded.

Depending on the browser and its settings, you can either choose where to save the file or the report will be saved in the default download directory.

Example of a compliance report

a) Overview

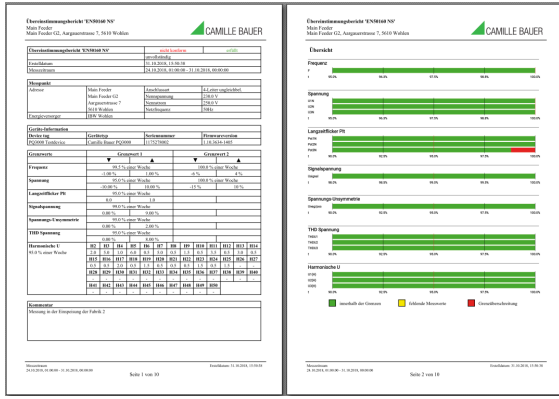

b) Details



c) Events

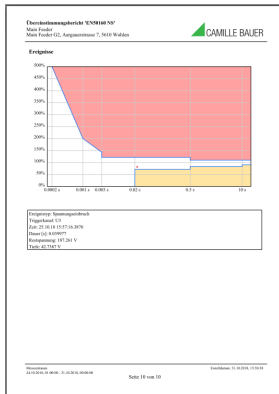

8.2 Measurement files

8.2.1 Accessing file information via webpage

You can access files stored in the device using the service menu **Local data storage | Download data**. Depending on the tasks defined in the data export scheduler the available file structure may be different:

- **csv**: container for all CSV files to be locally stored
- **pqdif**: container for all PQDIF files to be locally stored

The structure is displayed in a new tab.



Name	Last Modified	Size
csv/	2020-01-29 00:12	-
pqdif/	2020-01-03 00:12	-

Files in the **pqdif** folder are stored in a hierarchical time structure (year, month, day). By selecting the desired date and double-clicking on the appropriate file, a PQDIF may be easily downloaded.

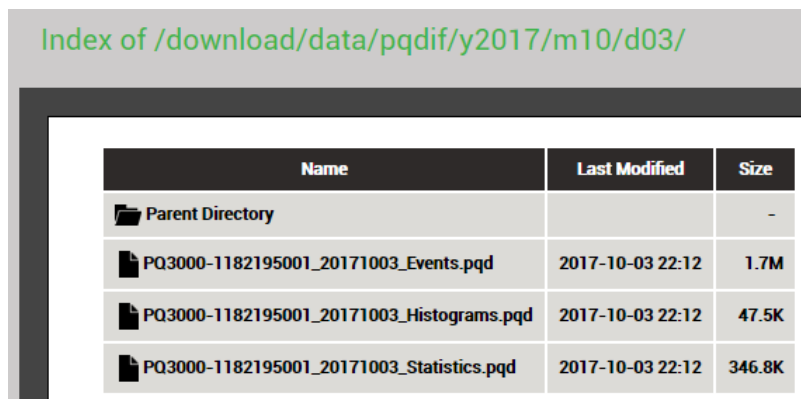

Name	Last Modified	Size
Parent Directory		-
PQ3000-1182195001_20171003_Events.pqd	2017-10-03 22:12	1.7M
PQ3000-1182195001_20171003_Histograms.pqd	2017-10-03 22:12	47.5K
PQ3000-1182195001_20171003_Statistics.pqd	2017-10-03 22:12	346.8K

PQDIF files may also be generated manually via web interface. This is possible for the present day (data since midnight) or for days in the past. The date can be selected:

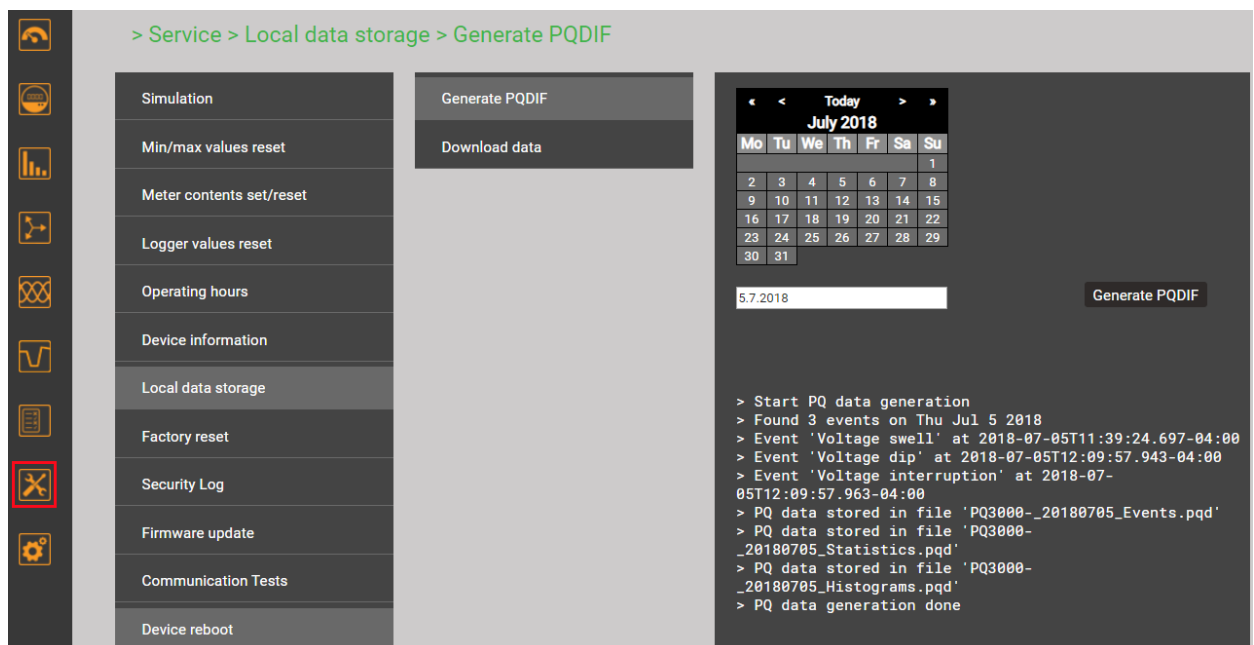

```
> Start PQ data generation
> Found 3 events on Thu Jul 5 2018
> Event 'Voltage swell' at 2018-07-05T11:39:24.697-04:00
> Event 'Voltage dip' at 2018-07-05T12:09:57.943-04:00
> Event 'Voltage interruption' at 2018-07-05T12:09:57.963-04:00
> PQ data stored in file 'PQ3000-_20180705_Events.pqd'
> PQ data stored in file 'PQ3000-_20180705_Statistics.pqd'
> PQ data stored in file 'PQ3000-_20180705_Histograms.pqd'
> PQ data generation done
```

If there are already PQDIF files stored in the device for the selected past day the below warning will be displayed.

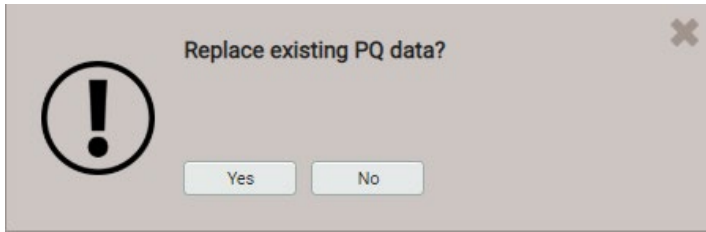

8.2.2 Evaluation of the PQDIF files

For the analysis of the data of the PQDIF files either the SmartCollect PM20 software (not included in the scope of delivery) or a free tool with limited functionality, such as the PQDiffactor from Electrotek Concepts (<http://www.pqview.com/pqdiffactor/>; registration required), can be used.

The **SmartCollect PM20** allows a more detailed analysis of the PQ data. Events can be graphically analyzed or displayed in an ITIC curve, which contains all PQ events with their residual voltage and event duration. You may also create conformity reports, e.g. according to EN50150.

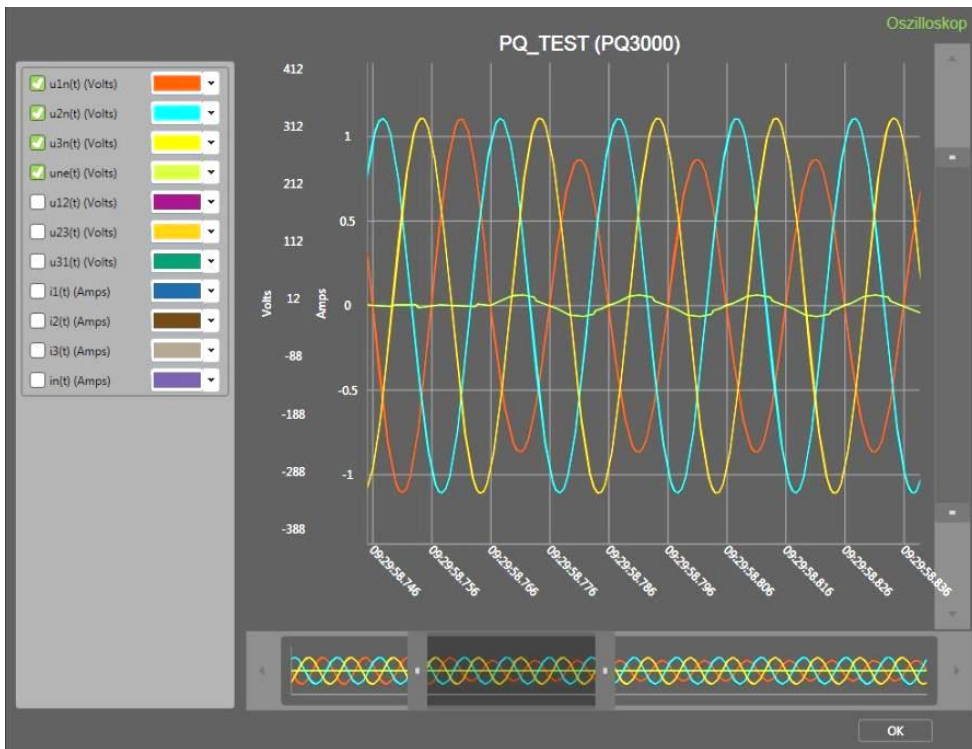

Representation of a voltage dip, using the SmartCollect PM20 software

9. Service, maintenance and disposal

9.1 Calibration and new adjustment

Each device is adjusted and checked before delivery. The condition as supplied to the customer is measured and stored in electronic form.

The uncertainty of measurement devices may be altered during normal operation if, for example, the specified ambient conditions are not met. If desired, in our factory a calibration can be performed, including a new adjustment if necessary, to assure the accuracy of the device.

9.2 Cleaning

The operating keys should be cleaned in regular intervals. Use a dry or slightly moist cloth for this.



Damage due to detergents

Detergents can damage the device. Therefore, do not use detergents.

9.3 Battery

The device contains a battery for buffering the internal clock. It cannot be changed by the user. The replacement can be done at the factory only.

In addition, devices with manufacturing date from 20/15 have a built-in UPS for bridging power supply failures. The associated battery pack needs to be replaced regularly. Due to aging the capacity of the battery decreases. To ensure a successful operation of the device during power interruptions the battery needs to be replaced every 3 up to 5 years. This replacement can be done at the factory only and is a standard procedure when the device is sent back for calibration.

9.4 Disposal

The product must be disposed in compliance with local regulations. This particularly applies to the built-in batteries.



Potential for Fire or Burning. Do not disassemble, crush, heat or burn the removed batteries.

10. Technical data

Inputs

Nominal voltage:	57.7...400 V _{LN} , 100...693 V _{LL} ;
Measurement max.:	520 V _{LN} , 900 V _{LL} (Sinus)
Measurement category:	600V CAT III
Consumption:	≤ U ² / 1.54 MΩ per phase
Impedance:	1.54 MΩ per phase
Overload capacity:	continuous: 520 V _{LN} , 900 V _{LL} 10 x 1 s, interval 10s: 800 V _{LN} , 1386 V _{LL}
Measurement uncertainty:	0.1%

Current

a) Rogowski probe ACF 2004_1

Current range:	up to 3800A
Measurement category:	1000V CAT III, 600V CAT IV
Accuracy (25°C, 50Hz):	± 0.5% of reading
Interchangeability:	± 0.5% of reading
Linearity (10-100% MB):	± 0.2% of reading
Phase error (45-65 Hz):	<± 1°
Temperature coefficient:	± 0.05% of reading /°C
Position sensitivity:	± 2% of reading
External field:	± 5A
Frequency range:	10Hz up to 20kHz (-1dB)

b) Current clamps

Measurement category:	600V CAT III
Frequency range:	30Hz up to 10kHz

10A / 1V

Current range CR:	10mA up to 10A AC
Output sensitivity:	100mV / A

Uncertainty:

Primary current	10...50mA	50...100mA	0,1...10A
Accuracy (of reading)	±5%	±2%	±1%
Phase error (typically)	undefined	5°	3°

100A / 1V

Current range CR:	1A up to 120A AC
Output sensitivity:	10mV / A

Uncertainty:

Primary current	1...10A	10...25A	25...100A
Accuracy (of reading)	±2%	±1.5%	±1%
Phase error (typically)	undefined	2.2°	2°

1000A / 1V

Current range CR:	1A up to 1200A AC
Output sensitivity:	1mV / A

Uncertainty:

Primary current	1...10A	10...100A	100...1200A
Accuracy (of reading)	±3%+0.1mV	±1.5%	±1%
Phase error (typically)	undefined	0.5°	0.3°

Nominal frequency: 42...50...58Hz or 50.5...60...69.5Hz, configurable

Sampling rate: 18 kHz

Internal data memory: 16 GB

Systems: Single phase; Split phase (2-phase system); 3-wire balanced load;
3-wire unbalanced load; 3-wire unbalanced load in Aron connection;
4-wire, unbalanced load

Power supply via power adapter
 Rated voltage: 100 ... 240V AC
 Secondary: 12V DC, 1A
 Frequency: 47 ... 63 Hz

Uninterruptible power supply (UPS), from manufacturing date 20/15

Type: VARTA Easy Pack EZPackL, UL listed MH16707
 Nominal voltage: 3.7V
 Capacity: 1150 mAh min., 4.5 Wh
 Operating duration: 5 times 3 minutes
 Life time: 3 up to 5 years, depending on operating and ambient conditions

Zero suppression, range limitations

The measurement of specific quantities is related to a pre-condition which must be fulfilled, that the corresponding value can be determined and sent via interface or displayed. If this condition is not fulfilled, a default value is used for the measurement.

Quantity	Condition	Default
Voltage	$U_x < 1\% U_{x_{nom}}$	0.00
Current	$I_x < 0,1\% I_{x_{nom}}$	0.00
PF	$S_x < 1\% S_{x_{nom}}$	1.00
QF, LF, tanφ	$S_x < 1\% S_{x_{nom}}$	0.00
Frequency	voltage and/or current input too low ¹⁾	Nominal frequency
Voltage unbalance	$U_x < 5\% U_{x_{nom}}$	0.00
Current unbalance	mean value of phase currents $< 5\% I_{x_{nom}}$	0.00
Phase angle U	at least one voltage $U_x < 5\% U_{x_{nom}}$	120°
Harmonics U, THD-U	fundamental $< 5\% U_{x_{nom}}$	0.00

¹⁾ Specific levels depend on the device configuration

Communication

Ethernet via RJ45 socket
 Protocol: Modbus/TCP, NTP, http, https, IPv4, IPv6
 Physics: Ethernet 100BaseTX
 Mode: 10/100 Mbit/s, full/half duplex, auto-negotiation

WLAN via USB socket
 Protocol: Modbus/TCP, http
 Access Point: up to 10 clients

The EDIMAX N150 Wireless LAN USB Adapter is in compliance with the essential requirements and other relevant provisions of Directive 1999/5/EC, 2009/125/EC.

FOR USE IN

Internal clock (RTC)

Uncertainty: ± 2 minutes / month (15 up to 30°C)
 Synchronization: none, via Ethernet ([NTP protocol](#)) or [GPS](#)
 Running reserve: > 10 years

Ambient conditions, general information

Operating temperature:	• Device without UPS: –10 up to <u>15 up to 30</u> up to + 55°C • Device with UPS: 0 up to <u>15 up to 30</u> up to + 35°C (if used outside this operating temperature range, it is not ensured that the UPS battery pack is recharged).
Storage temperature:	Base device: -25 up to + 70°C; Battery pack UPS: -20...60°C (<1 month); -20°...45°C (< 3 months); -20...30°C (< 1 year)
Temperature influence:	0.5 x measurement uncertainty per 10 K
Long term drift:	0.5 x measurement uncertainty per year
Usage group:	II (acc. EN 60 688)
Relative humidity:	< 95% no condensation
Altitude:	≤ 2000 m max.

Safety

Protection class:	II (protective insulation, voltage inputs via protective impedance)
Pollution degree:	2
Protection:	IP65 (closed housing)

Power Quality

Type of device:	(IEC 62586-1) PQI-A FI2: Power Quality Instrument – Class A; Fixed installation; Indoor environment with controlled temperature variations (2)
Measurement cycle:	200ms (50Hz: 10 cycles; 60Hz: 12 cycles)
Flagging concept:	Multiphase approach in accordance with IEC 61000-4-30
Certification:	According to IEC62586-2 (for verifying compliance with IEC 61000-4-30)
Certification body:	Federal Institute of Metrology METAS, an independent and accredited laboratory
Test records:	Conformity was proven at 230V / 50Hz and 120V / 60Hz

Conformity assessment against IEC 62586-2:2017

Clause	PQ parameter	Compliance 120 V- 60 Hz	Compliance 230 V – 50 Hz
6.1	Power frequency	Yes	Yes
6.2	Magnitude of the supply voltage	Yes	Yes
6.3	Flicker	Yes (class F1)	Yes (class F1)
6.4	Supply voltage interruptions, dips and swells	Yes	Yes
6.5	Supply voltage unbalance	Yes	Yes
6.6	Voltage harmonics	Yes	Yes
6.7	Voltage interharmonics	Yes	Yes
6.8	Mains signalling voltage of the supply voltage	Yes	Yes
6.9	Measurement of underdeviation / overdeviation parameters	Yes	Yes
6.10	Flagging	Yes	Yes
6.11	Clock uncertainty testing	Yes	Yes
6.12	Variations due to external influence quantities	Yes	Yes
6.13	Rapid voltage changes (RVC)	Yes	Yes
6.14	Magnitude of current	Yes	Yes
6.15	Harmonic current	Yes	Yes
6.16	Interharmonic currents	Yes	Yes
6.17	Current imbalance	Yes	Yes

Applied regulations, standards and directives

IEC/EN 61010-1	Safety regulations for electrical measuring, control and laboratory equipment
IEC/EN 61000-4-30 Ed.3	Power quality measurement methods
IEC/EN 61000-4-7	General guide on harmonics and interharmonics measurements
IEC/EN 61000-4-15	Flickermeter - Functional and design specifications
IEEE 1159.3	Recommended Practice for the Transfer of Power Quality Data
IEC 62586-1 Ed.2	Power quality measurement in power supply systems – Power quality instruments (PQI)
IEC 62586-2 Ed.2	Power quality measurement in power supply systems – Functional tests and uncertainty requirements
EN50160	Voltage characteristics of electricity supplied by public distribution systems
DIN 40110	AC quantities
IEC/EN 60068-2-1/ -2/-3/-6/-27:	Ambient tests -1 Cold, -2 Dry heat, -3 Damp heat, -6 Vibration, -27 Shock
IEC/EN 61000-6-4	Electromagnetic compatibility (EMC): Emission standard for industrial environments
IEC/EN 61000-6-5	Electromagnetic compatibility (EMC): Immunity for equipment used in power station and substation environment
IEC/EN 60529	Protection type by case
UL94	Tests for flammability of plastic materials for parts in devices and appliances
2011/65/EU (RoHS)	EU directive on the restriction of the use of certain hazardous substances

Warning

This is a class A product. In a domestic environment this product may cause radio interference in which case the user may be required to take adequate measures.

This device complies with part 15 of the FCC:

Operation is subject to the following two conditions: (1) This device may not cause harmful interference, and (2) this device must accept any interference received, including interference that may cause undesired operation.

This Class A digital apparatus complies with Canadian ICES-003.

FCC statement

The following statement applies to the products covered in this manual, unless otherwise specified herein. The statement for other products will appear in the accompanying documentation.

NOTE: This equipment has been tested and found to comply with the limits for a Class A digital device, pursuant to Part 15 of the FCC Rules and meets all requirements of the Canadian Interference-Causing Equipment Standard ICES-003 for digital apparatus. These limits are designed to provide reasonable protection against harmful interference in a residential installation. This equipment generates, uses, and can radiate radio frequency energy and, if not installed and used in accordance with the instructions, may cause harmful interference to radio communications. However, there is no guarantee that interference will not occur in a particular installation. If this equipment does cause harmful interference to radio or television reception, which can be determined by turning the equipment off and on, the user is encouraged to try to correct the interference by one or more of the following measures:

- Reorient or relocate the receiving antenna.
- Increase the separation between the equipment and receiver.
- Connect the equipment into an outlet on a circuit different from that to which the receiver is connected.
- Consult the dealer or an experienced radio/T.V. technician for help.

Camille Bauer Metrawatt AG is not responsible for any radio television interference caused by unauthorized modifications of this equipment or the substitution or attachment of connecting cables and equipment other than those specified by Camille Bauer Metrawatt AG. The correction of interference caused by such unauthorized modification, substitution or attachment will be the responsibility of the user.

Annex

A Description of measured quantities

Used abbreviations

1L	Single phase system
2L	Split phase; system with 2 phases and center tap
3Lb	3-wire system with balanced load
3Lu	3-wire system with unbalanced load
3Lu.A	3-wire system with unbalanced load, Aron connection (only 2 currents connected)
4Lu	4-wire system with unbalanced load

Incoming / outgoing / inductive / capacitive

The device provides information for all four quadrants. Quadrants are normally identified using the roman numbers I, II, III and IV, as shown in the adjacent graphic. Depending on whether the system is viewed from the producer or consumer side, the interpretation of the quadrants is changing: The energy built from the active power in the quadrants I+IV can either be seen as delivered or consumed active energy.

By avoiding terms like incoming / outgoing energy and inductive or capacitive load when displaying data, an independent interpretation of the 4-quadrant information becomes possible. Instead the quadrant numbers I, II, III or IV, a combination of them or an appropriate graphical representation is used. You can select your own point of view by selecting the reference arrow system (load or generator) in the settings of the measurement.

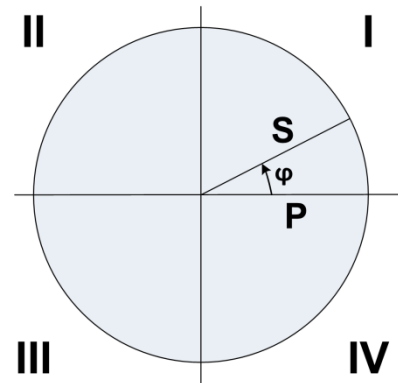

A1 Basic measurements

The basic measured quantities are calculated each 200ms by determining an average over 10 cycles at 50Hz resp. 12 cycles at 60Hz. If a measurement is available depends on the selected system.

Depending on the measured quantity also minimum and maximum values are determined and non-volatile stored with timestamp. These values may be reset by the user via display, see [resetting of measurements](#) (7.3).

Measurement	present	max	min	1L	2L	3Lb	3Lu	3Lu.A	4Lu
Voltage U	•	•	•	√	√				
Voltage U _{1N}	•	•	•		√				√
Voltage U _{2N}	•	•	•		√				√
Voltage U _{3N}	•	•	•						√
Voltage U ₁₂	•	•	•			√	√	√	√
Voltage U ₂₃	•	•	•			√	√	√	√
Voltage U ₃₁	•	•	•			√	√	√	√
Voltage U _{NE} ¹⁾	•	•		√	√	√	√	√	√
Current I	•	•		√		√			
Current I1	•	•			√		√	√	√
Current I2	•	•			√		√	√	√
Current I3	•	•					√	√	√
Neutral current I _N	•	•		√	√				√
Earth current I _{PE} (calculated)	•	•							√
Active power P	•	•		√	√	√	√	√	√
Active power P1	•	•			√				√
Active power P2	•	•			√				√
Active power P3	•	•							√
Fundamental active power P(H1)	•	•		√	√	√	√	√	√
Fundamental active power P1(H1)	•	•			√				√
Fundamental active power P2(H1)	•	•			√				√
Fundamental active power P3(H1)	•	•							√
Total reactive power Q	•	•		√	√	√	√	√	√
Total reactive power Q1	•	•			√				√
Total reactive power Q2	•	•			√				√
Total reactive power Q3	•	•							√
Distortion reactive power D	•	•		√	√	√	√	√	√
Distortion reactive power D1	•	•			√				√
Distortion reactive power D2	•	•			√				√
Distortion reactive power D3	•	•							√
Fundamental reactive power Q(H1)	•	•		√	√	√	√	√	√
Fundamental reactive power Q1(H1)	•	•			√				√
Fundamental reactive power Q2(H1)	•	•			√				√
Fundamental reactive power Q3(H1)	•	•							√
Apparent power S	•	•		√	√	√	√	√	√
Apparent power S1	•	•			√				√
Apparent power S2	•	•			√				√
Apparent power S3	•	•							√
Fundamental apparent power S(H1)	•	•		√	√	√	√	√	√
Fundamental apparent power S1(H1)	•	•			√				√
Fundamental apparent power S2(H1)	•	•			√				√
Fundamental apparent power S3(H1)	•	•							√
Frequency F	•	•	•	√	√	√	√	√	√
Power factor PF	•			√	√	√	√	√	√
Power factor PF1	•				√				√
Power factor PF2	•				√				√
Power factor PF3	•								√
PF quadrant I			•	√	√	√	√	√	√
PF quadrant II			•	√	√	√	√	√	√
PF quadrant III			•	√	√	√	√	√	√
PF quadrant IV			•	√	√	√	√	√	√

Measurement	prese	max	min	1L	2L	3Lb	3Lu	3Lu.A	4Lu
Reactive power factor QF	•			√	√	√	√	√	√
Reactive power factor QF1	•				√				√
Reactive power factor QF2	•				√				√
Reactive power factor QF3	•								√
Load factor LF	•			√	√	√	√	√	√
Load factor LF1	•				√				√
Load factor LF2	•				√				√
Load factor LF3	•								√
cosφ (H1)	•			√	√	√	√	√	√
cosφ L1 (H1)	•				√				√
cosφ L2 (H1)	•				√				√
cosφ L3 (H1)	•								√
cosφ (H1) quadrant I			•	√	√	√	√	√	√
cosφ (H1) quadrant II			•	√	√	√	√	√	√
cosφ (H1) quadrant III			•	√	√	√	√	√	√
cosφ (H1) quadrant IV			•	√	√	√	√	√	√
tanφ (H1)	•			√	√	√	√	√	√
tanφ L1 (H1)	•				√				√
tanφ L2 (H1)	•				√				√
tanφ L3 (H1)	•								√
$U_{mean}=(U1N+U2N)/2$	•				√				
$U_{mean}=(U1N+U2N+U3N)/3$	•								√
$U_{mean}=(U12+U23+U31)/3$	•					√	√	√	
$I_{mean}=(I1+I2)/2$	•				√				
$I_{mean}=(I1+I2+I3)/3$	•						√		√
IMS, Average current with sign of P	•			√	√	√	√	√	√
Phase angle between U1 and U2	•					√	√	√	√
Phase angle between U2 and U3	•					√	√	√	√
Phase angle between U3 and U1	•					√	√	√	√
Angle between U and I	•			√		√	√	√	
Angle between U1 and I1	•				√				√
Angle between U2 and I2	•				√				√
Angle between U3 and I3	•								√
Maximum ΔU <> Um	•	•			√	√	√	√	√
Maximum ΔI <> Im	•	•			√		√		√

• Available via communication interface only

¹⁾ For 3-wire systems: Homopolar voltage, only if its measurement has been activated

Power factors

The **power factor PF** gives the relation between active and apparent power. If there are no harmonics present in the system, it corresponds to the $\cos\phi$ or displacement power factor. The PF has a range of $-1...0...+1$, where the sign gives the direction of energy flow.

The **load factor LF** is a quantity derived from the PF, which allows making a statement about the load type. Only this way it's possible to measure a range like 0.5 capacitive ... 1 ... 0.5 inductive in a non-ambiguous way.

The **reactive power factor QF** gives the relation between reactive and apparent power.

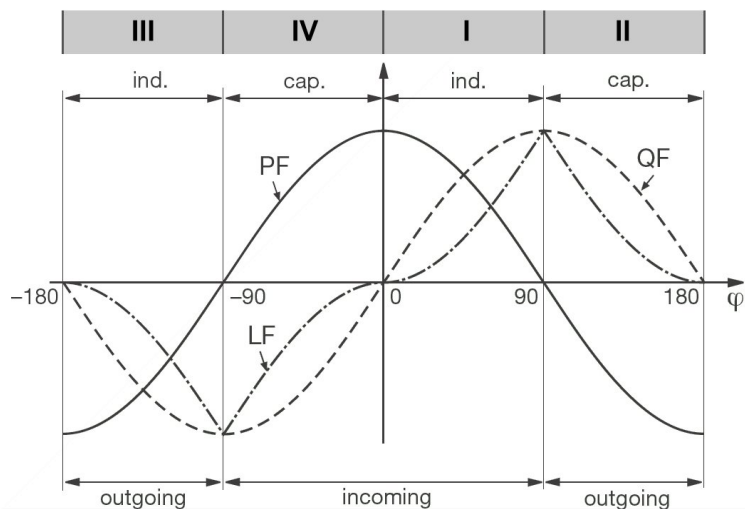

Example from the perspective of an energy consumer

Reactive power

Most of the loads consume a combination of ohmic and inductive current from the power system. Reactive power arises by means of the inductive load. But the number of non-linear loads, such as RPM regulated drives, rectifiers, thyristor controlled systems or fluorescent lamps, is increasing. They cause non-sinusoidal AC currents, which may be represented as a sum of harmonics. Thus the reactive power to transmit increases and leads to higher transmission losses and higher energy costs. This part of the reactive power is called distortion reactive power.

Normally reactive power is unwanted, because there is no usable active component in it. Because the transmission of reactive power over long distances is uneconomic, it makes sense to install compensation systems close to the consumers. So transmission capacities may be used better and losses and voltage drops by means of harmonic currents can be avoided.

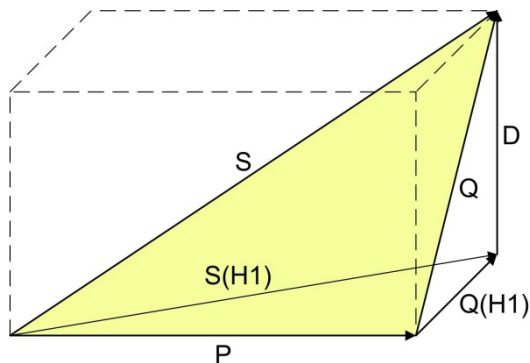

- P: Active power
- S: Apparent power including harmonic components
- S1: Fundamental apparent power
- Q: Total reactive power
- Q(H1): Fundamental reactive power
- D: Distortion reactive power

The reactive power may be divided in a fundamental and a distortion component. Only the fundamental reactive power may be compensated directly by means of the classical capacitive method. The distortion components have to be combated using inductors or active harmonic conditioners.

The **load factor PF** is the relation between active power P and apparent power S, including all possibly existing harmonic parts. This factor is often called $\cos\varphi$, which is only partly correct. The PF corresponds to the **cosφ** only, if there is no harmonic content present in the system. So the **cosφ** represents the relation between the active power P and the fundamental apparent power S(H1).

The **tanφ** is often used as a target quantity for the capacitive reactive power compensation. It corresponds to the relation of the fundamental reactive power Q(H1) and the active power P.

Zero displacement voltage U_{NE}

Starting from the generating system with star point E (which is normally earthed), the star point (N) on load side is shifted in case of unbalanced load. The zero displacement voltage between E and N may be determined by a vectorial addition of the voltage vectors of the three phases:

$$\underline{U}_{NE} = - (\underline{U}_{1N} + \underline{U}_{2N} + \underline{U}_{3N}) / 3$$

A displacement voltage may also occur due to harmonics of order 3, 9, 15, 21 etc., because the dedicated currents add in the neutral wire.

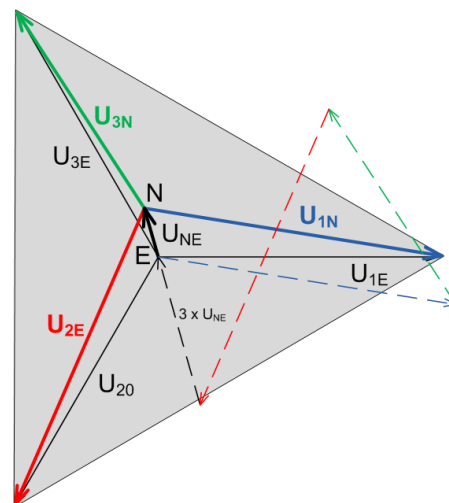

A2 Harmonic analysis

The harmonic analysis is performed according IEC 61000-4-7 over 10 cycles at 50Hz resp. 12 cycles at 60Hz. If a measured quantity is available depends on the selected system.

Measurement	prese	max	1L	2L	3Lb	3Lu	3Lu.A	4Lu
THD Voltage U1N/U	•	•	√	√				√
THD Voltage U2N	•	•		√				√
THD Voltage U3N	•	•						√
THD Voltage U12	•	•			√	√	√	
THD Voltage U23	•	•			√	√	√	
THD Voltage U31	•	•			√	√	√	
THD Current I1/I	•	•	√	√	√	√	√	√
THD Current I2	•	•		√		√	√	√
THD Current I3	•	•				√	√	√
TDD Current I1/I	•	•	√	√	√	√	√	√
TDD Current I2	•	•		√		√	√	√
TDD Current I3	•	•				√	√	√
Harmonic contents 2 nd ...50 th U1N/U	•	•	√	√				√
Harmonic contents 2 nd ...50 th U2N	•	•		√				√
Harmonic contents 2 nd ...50 th U3N	•	•						√
Harmonic contents 2 nd ...50 th U12	•	•			√	√	√	
Harmonic contents 2 nd ...50 th U23	•	•			√	√	√	
Harmonic contents 2 nd ...50 th U31	•	•			√	√	√	
Harmonic contents 2 nd ...50 th I1/I	•	•	√	√	√	√	√	√
Harmonic contents 2 nd ...50 th I2	•	•		√		√	√	√
Harmonic contents 2 nd ...50 th I3	•	•				√	√	√

Harmonic contents are available up to the 89th (50Hz) or 75th (60Hz) on the Modbus interface

• Available via communication interface only

Harmonics

Harmonics are multiples of the fundamental resp. system frequency. They arise if non-linear loads, such as RPM regulated drives, rectifiers, thyristor controlled systems or fluorescent lamps are present in the power system. Thus undesired side effects occur, such as additional thermal stress to operational resources or electrical mains, which lead to an advanced aging or even damage. Also the reliability of sensitive loads can be affected and unexplainable disturbances may occur. In industrial networks the image of the harmonics gives good information about the kind of loads connected. See also:

► [Increase of reactive power due to harmonic currents](#) (annex A1)

TDD (Total Demand Distortion)

The complete harmonic content of the currents is calculated additionally as Total Demand Distortion, briefly TDD. It is related to the maximum load current in accordance with IEEE 519. Only this way it's possible to estimate the influence of the current harmonics on the connected equipment correctly. The TDD value is especially used for conformity assessment in accordance with IEEE 519.

Maximum values

The maximum values of the harmonic analysis arise from the monitoring of THD and TDD. The maximum values of individual harmonics are not monitored separately, but are stored if a maximum value of THD or TDD is detected. The image of the maximum harmonics therefore always corresponds to the dedicated THD resp. TDD.

A3 System imbalance

Measured quantity	present	max	1L	2L	3Lb	3Lu	3Lu.A	4Lu
UR1: Positive sequence [V]	•				√	√	√	√
UR2: Negative sequence [V]	•				√	√	√	√
U0: Zero sequence [V]	•							√
U: Imbalance UR2/UR1	•	•			√	√	√	√
U: Imbalance U0/UR1	•	•						√
IR1: Positive sequence [A]	•					√		√
IR2: Negative sequence [A]	•					√		√
I0: Zero sequence [A]	•							√
I: Imbalance IR2/IR1	•	•				√		√
I: Imbalance I0/IR1	•	•						√

• Available via communication interface only

Imbalance in three-phase systems may occur due to single-phase loads, but also due to failures, such as e.g. the blowing of a fuse, an earth fault, a phase failure or an isolation defect. Also harmonics of the 3rd, 9th, 15th, 21st etc. order, which add in the neutral wire, may lead to imbalance. Operating resources dimensioned to rated values, such as three-phase generators, transformers or motors on load side, may be excessively stressed by imbalance. So a shorter life cycle, a damage or failure due to thermal stress can result. Therefore monitoring imbalance helps to reduce the costs for maintenance and extends the undisturbed operating time of the used resources.

Imbalance or unbalanced load relays use different measurement principles. One of them is the approach of the symmetrical components, the other one calculates the maximum deviation from the mean-value of the three phase values. The results of these methods are not equal and don't have the same intention. Both of these principles are implemented in the device.

Symmetrical components (acc. Fortescue)

The imbalance calculation method by means of the symmetrical components is ambitious and intensive to calculate. The results may be used for disturbance analysis and for protection purposes in three-phase systems. The real existing system is divided in symmetrical system parts: A positive sequence, a negative sequence and (for systems with neutral conductor) a zero sequence system. The approach is easiest to understand for rotating machines. The positive sequence represents a positive rotating field, the negative sequence a negative (braking) rotating field with opposite sense of direction. Therefore the negative sequence prevents that the machine can generate the full turning moment. For e.g. generators the maximum permissible current imbalance is typically limited to a value of 8...12%.

Maximum deviation from the mean value

The calculation of the maximum deviation from the mean value of the phase currents resp. phase voltages gives the information if a grid or substation is imbalanced loaded. The results are independent of rated values and the present load situation. So a more symmetrical system can be aspired, e.g. by changing loads from one phase to another.

Also failure detection is possible. The capacitors used in compensation systems are wear parts, which fail quite often and then have to be replaced. When using three phase power capacitors all phases will be compensated equally which leads to almost identical currents flowing through the capacitors, if the system load is comparable. By monitoring the current imbalance it's then possible to estimate if a capacitor failure is present.

The maximum deviations are calculated in the same steps as the instantaneous values and therefore are arranged there ([see A1](#)).

A4 Mean values and trend

Measured quantity		Present	Trend	max	min	History
Active power I+IV	10s...60min. ¹⁾	•	•	•	•	5
Active power II+III	10s...60min. ¹⁾	•	•	•	•	5
Reactive power I+II	10s...60min. ¹⁾	•	•	•	•	5
Reactive power III+IV	10s...60min. ¹⁾	•	•	•	•	5
Apparent power	10s...60min. ¹⁾	•	•	•	•	5
Mean value quantity 1	10s...60min. ²⁾	•	•	•	•	1
.....						
Mean value quantity 12	10s...60min. ²⁾	•	•	•	•	1

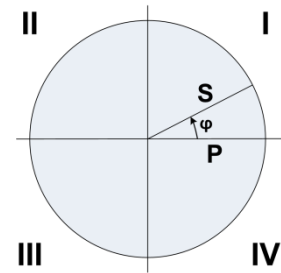

¹⁾ Interval time t1 ²⁾ Interval time t2

The device calculates automatically the mean values of all system power quantities. In addition up to 12 further mean value quantities can be freely selected.

Calculating the mean-values

The mean value calculation is performed via integration of the measured instantaneous values over a configurable averaging interval. The interval time may be selected in the range from 10 seconds up to one hour. Possible interim values are set the way that a multiple of it is equal to a minute or an hour. Mean values of power quantities (interval time t1) and free quantities (interval time t2) may have different averaging intervals.

Synchronization

For the synchronization of the averaging intervals the internal clock is used. It should be synchronized via GPS or NTP to avoid drifting of the intervals.

Trend

The estimated final value (trend) of mean values is determined by weighted addition of measurements of the past and the present interval. It serves for early detection of a possible exceeding of a given maximum value. This can then be avoided, e.g. by switching off an active load.

History

For mean values of system powers the last 5 interval values may be displayed on the device or read via interface. For configurable quantities the value of the last interval is provided via communication interface.

Bimetal current

This measured quantity serves for measuring the long-term effect of the current, e.g. for monitoring the warming of a current-carrying line. To do so, an exponential function is used, similar to the charging curve of a capacitor. The response time of the bimetal function can be freely selected, but normally it corresponds to the interval for determining the power mean-values.

Measured quantity	Present	max	1L	2L	3Lb	3Lu	3Lu.A	4Lu
Bimetal current IB, 1...60min. ³⁾	•	•	√		√			
Bimetal current IB1, 1...60min. ³⁾	•	•		√		√	√	√
Bimetal current IB2, 1...60min. ³⁾	•	•		√		√	√	√
Bimetal current IB3, 1...60min. ³⁾	•	•				√	√	√

³⁾ Interval time t3

A5 Meters

Measured quantity		1L	2L	3Lb	3Lu	3Lu.A	4Lu
Active energy I+IV, high tariff		•	•	•	•	•	•
Active energy II+III, high tariff		•	•	•	•	•	•
Reactive energy I+II, high tariff		•	•	•	•	•	•
Reactive energy III+IV, high tariff		•	•	•	•	•	•
User configured meter 1	Only basic quantities can be selected which are supported in the present system.						
User configured meter 2							
User configured meter 3							
User configured meter 4							
User configured meter 5							
User configured meter 6							
User configured meter 7							
User configured meter 8							
User configured meter 9							
User configured meter 10							
User configured meter 11							
User configured meter 12							

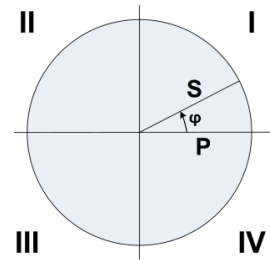

Standard meters

The meters for active and reactive energy of the system are always active.

User configured meters

To each of these meters the user can freely assign a basic quantity.

Programmable meter resolution



For all meters the resolution (displayed unit) can be selected almost freely. This way, applications with short measurement times, e.g. energy consumption of a working day or shift, can be realized. The smaller the basic unit is selected, the faster the meter overflow is reached.

B Network settings in Windows

Depending on the Windows version used network settings and network status are arranged differently. The below images are created using Windows 7.

Display / change network settings



Via control panel select **Network and Sharing Center**

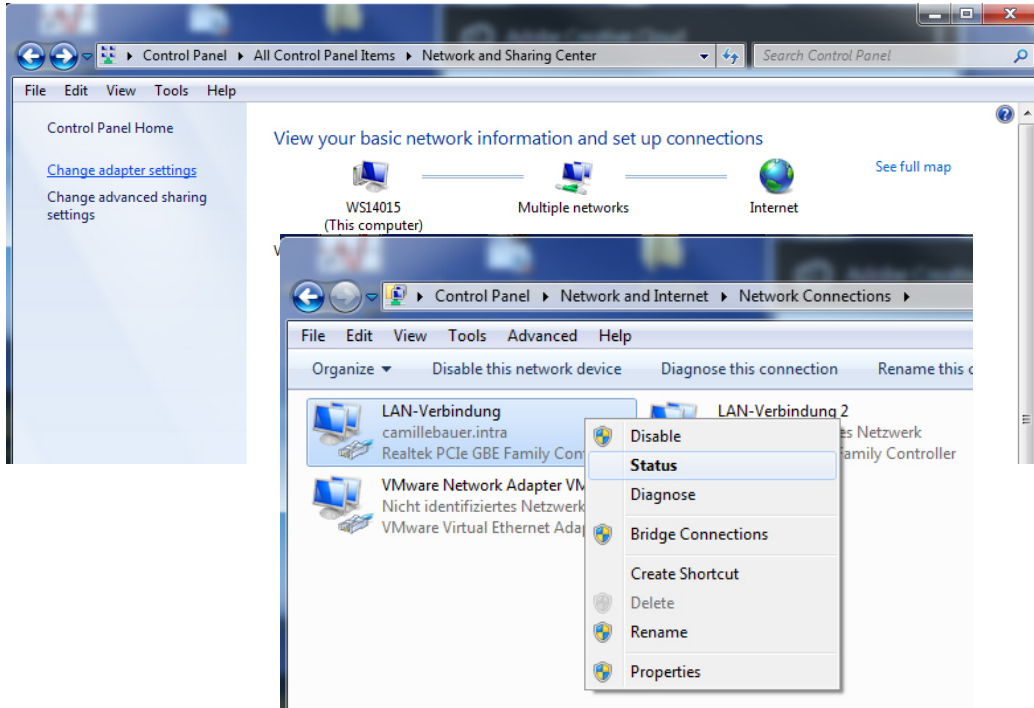

Via **Status** the active settings of the selected LAN interface can be displayed:

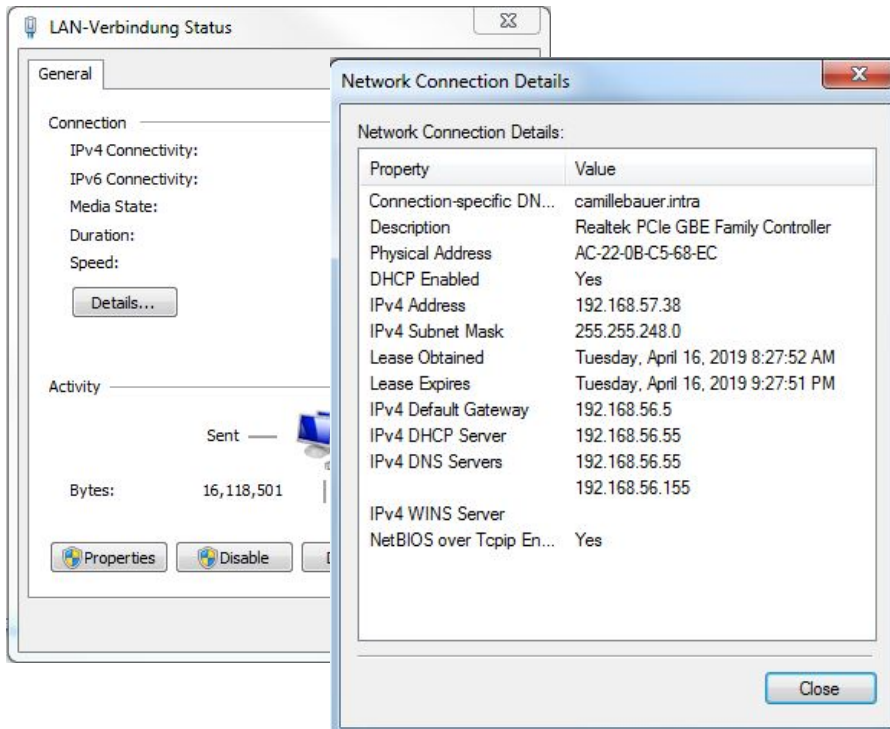

For changing the settings of the LAN interface, display the settings of the selected LAN interface via **Properties** first:

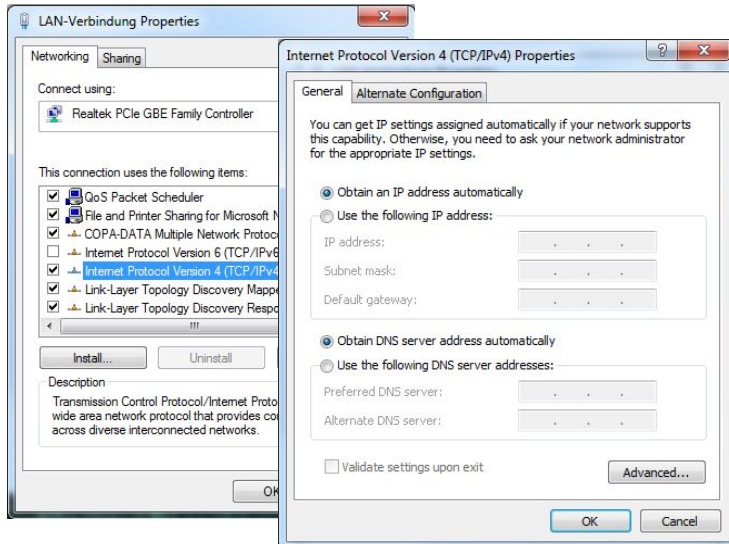

The setting **Obtain IP address automatically** indicates that the network settings are obtained from a DHCP server on the network.

If the PC is connected directly to the measurement device or the network does not have a DHCP server, the network settings are undefined.

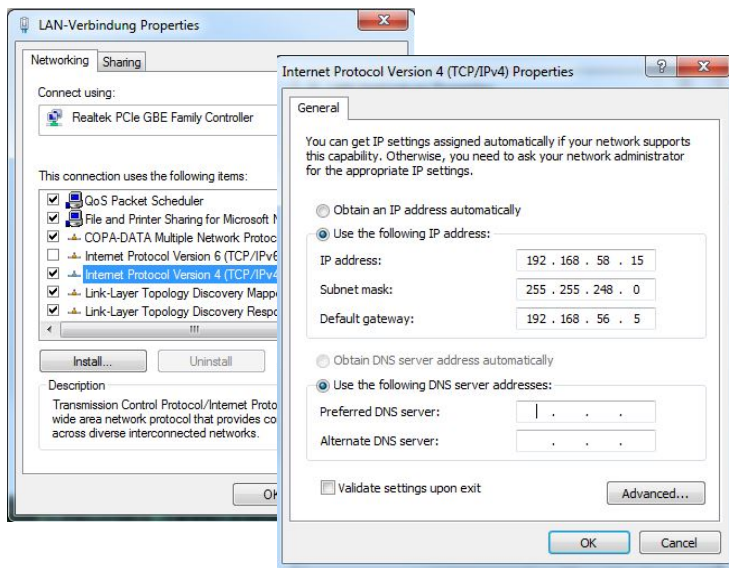

The network settings may be specified manually. Entered settings are activated after confirmation with <OK>.

The current settings of all LAN connections of a computer can also be queried via the DOS command prompt. A DOS window can be opened in two ways:

- Start | Execute**, type **cmd** as command
- Start | All programs | Accessories | command prompt**

In the DOS windows enter the command **ipconfig**.

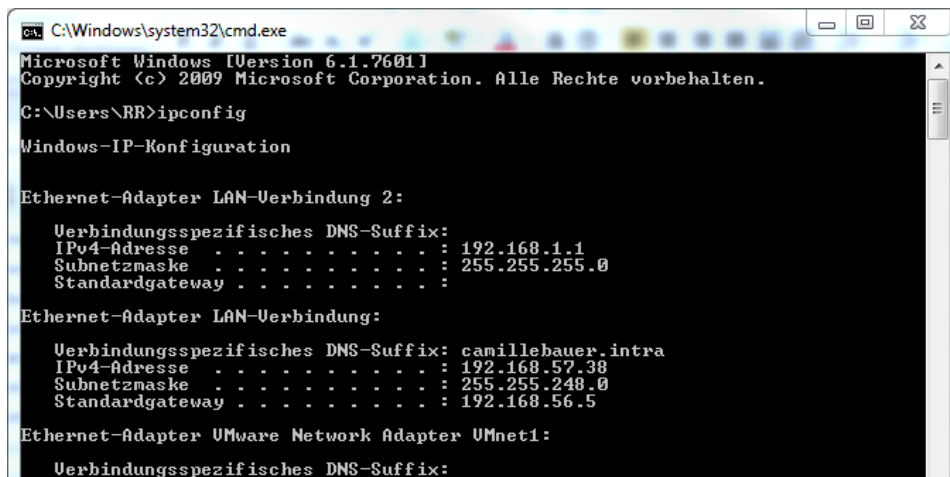

ACF 2004_1

IP65 rated FLEXIBLE AC CURRENT PROBE



SAFETY

The following symbols appear on the product:



Attention! Refer to Manual.



Do not apply around or remove from HAZARDOUS LIVE conductors without additional protective means. "Additional protective means" can be de-energizing the circuit or wearing protective clothing suitable for high voltage work.



Double/Reinforced Insulation.



Complies with the relevant European standards.



Do not dispose of this product as unsorted municipal waste. Contact a qualified recycler for disposal.



Read all instructions completely before using this product.

To avoid electric shock:

- Use caution during installation and use of this product. High voltages and currents may be present in circuit under test.
- This product must be used only by qualified personnel practicing applicable safety precautions.
- Do not install this product on live conductors.
- Always de-energize circuit under test before installing flexible measuring head. Always inspect connecting cable and flexible probe for damage before using this product.
- Do not use product if damaged.
- Always connect electronics unit to display device before installing the flexible measuring head.
- Always wear protective clothing and gloves if hazardous live parts are present in the installation where the measurement is carried out.
- If the probe is used in a manner not specified by the manufacturer the protection provided by the equipment may be impaired.

MAINTENANCE



Do not use ACF 2004_1 if damaged

- Always inspect connecting cable and flexible probe for damage before use.
- To avoid electric shock, keep the ACF clean and free of surface contamination.
- Use Isopropyl alcohol to clean the probe.
- Make sure the flexible probe and the connecting cable are dry before further use.

OPERATION



Read safety section of instructions before operating this product.



Ensure conductor to be tested is de-energized

Connect the output of the probe to the input of a measurement device.



The flexible current probe is not for use on conductors with a potential of over 1000V (CAT III) or 600V (CAT IV).

Wrap the flexible probe around the conductor to be tested, close coupling. Energize the circuit under test. Locate the coupling away from nearby conductors.



Always use appropriate equipment for personal protection. Do not use the flexible current probe to measure bare conductors unless wearing protective clothing suitable for high voltage work.

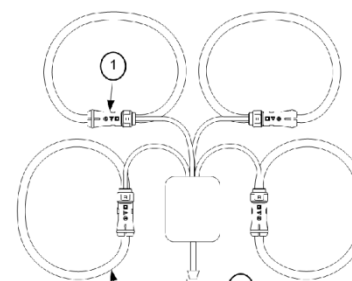
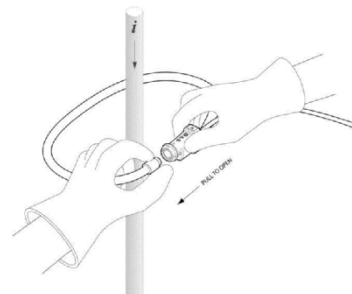

1. Probe Coupling
2. Probe Output Cable
3. Flexible Current Probe

INDEX

A	
Alarming	28
C	
Commissioning	42
Compliance report.....	55
cosφ.....	66
D	
Data recording start	45
Device overview.....	8
E	
Ethernet installation	10
F	
FCC statement.....	63
Firewall	12
G	
GPS	40
H	
HTTPS.....	22
I	
I, II, III, IV	64
Installation check	42
M	
Measurements	64
Basic quantities.....	65
Bimetal current.....	70
Harmonic analysis.....	68
Load factors	66
Mean values and trend.....	70
Meters.....	71
Reset	44
System imbalance.....	69
Zero displacement voltage	67
N	
NTP	12
P	
PQ event recordings	51
PQ monitoring.....	25
PQ statistic.....	53
PQDIF.....	31, 57
PQ-Easy Report.....	55
R	
Reactive power	67
Reset of measurements	44
Roman numbers	64
S	
Safety instructions.....	33
Scope of supply	6
Security system.....	18
Service and maintenance.....	59
Summary alarm.....	30
Symmetrical components.....	69
SYSLOG	23
T	
Technical data.....	60
Time synchronization	
GPS	40
NTP.....	12
W	
Whitelist	22
Z	
Zero suppression	61