

# LINAX 4000M

14082B  
1 / 12.95

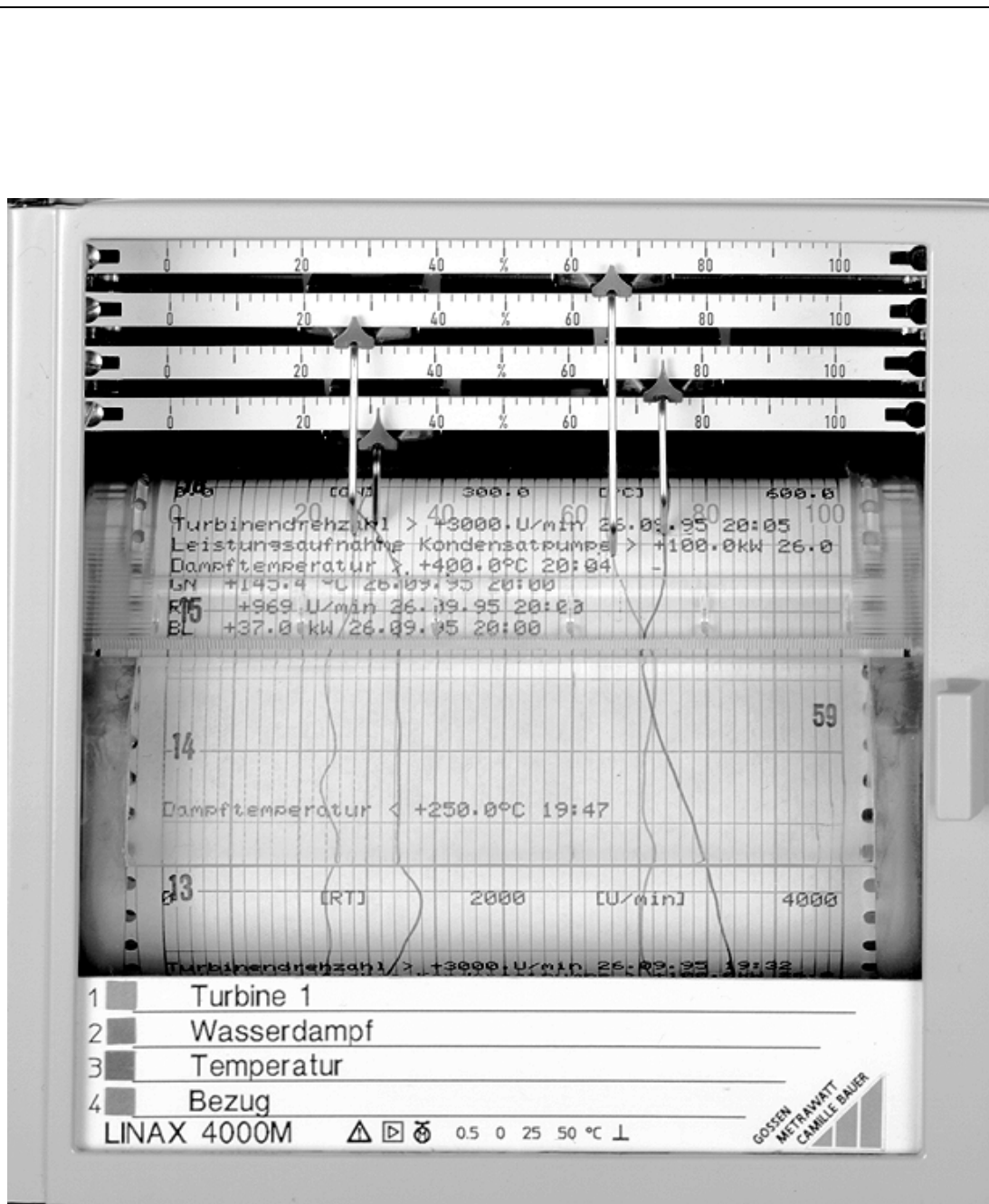

# Contents

	Page
1 Installation and startup . . . . .	3
1.1 Scope of delivery . . . . .	3
1.2 Choosing the mounting site . . . . .	3
1.3 Installation. . . . .	3
1.4 Connection . . . . .	4
1.4.1 Connecting the input signals . . . . .	4
1.4.2 Connecting the power supply . . . . .	4
1.5 Chart loading . . . . .	5
1.5.1 Recording table for roll chart . . . . .	5
1.5.2 Recording table for fanfold chart . . . . .	5
1.6 Installing the fiber pen insert / print insert . . . . .	6
1.7 Switching the recorder on. . . . .	6
1.8 Positioning the recording chart . . . . .	6
2 Operation . . . . .	7
2.1 Removing the recording chart . . . . .	7
2.2 Removing the recording chart from the take-up roll. . . . .	7
2.3 Changing the chart speed. . . . .	7
2.4 Standby function. . . . .	7
3 Reconfiguration . . . . .	8
3.1 Changing the measuring ranges . . . . .	8
3.1.1 Hardware matching by means of jumpers . . . . .	8
3.2 Replacing scales. . . . .	9
3.3 Replacing the label for the measuring points . . . . .	9
4 Maintenance. . . . .	10
4.1 Fuse replacement . . . . .	10
5 Technical data . . . . .	11
6 Packing . . . . .	14

## Important information for your safety! It must absolutely be read and followed!

A condition of correct and safe operation of the continuous-line recorder LINAX 400M is that it is transported and stored in a suitable manner, competently installed and started as well as correctly operated and carefully serviced.

Only those persons must work on the recorder who are familiar with installation, startup, operation and servicing of comparable equipment and who have the qualification required for their work.

The contents of these operating instructions and the safety notes affixed to the unit are to be observed.

The regulations, standards and directives mentioned in these operating instructions are for the Federal Republic of Germany. When using the recorder in other countries, relevant national rules must be followed.

The recorder is constructed and tested according to DIN EN 61 010-1 "Safety requirements for electronic measuring instruments", it left the factory in safe and proper condition. To maintain this condition and to ensure safe operation, the safety notes in these operating instructions with the heading "Caution" must be followed. Otherwise, persons could be endangered and the unit itself as well as other equipment and facilities could be damaged.

If the information contained in these operating instructions should not be sufficient in certain cases, the GOSSEN-METRAWATT Service will be glad to provide further information.

## Reference symbols in the text

<Key>	Designation of the keys in the display and control panel
Display	Non-flashing presentation on the display
<i>Display</i>	Flashing presentation on the display

The information "right", "left" or "top", "bottom" – unless otherwise stated – is on the understanding that the viewer looks at the front.

## Supplementary documents

Parameterizing instructions LINAX 4000M	14083B
Interface description LINAX 4000M	14084B

## Applications and brief description

The LINAX 4000M is a microprocessor-controlled continuous-line recorder. It comes in two different versions:

- 1 to 4 line channels,
- 1 to 3 line channels and a printer channel.

The printer channel permits the recording of a measured value and generates text printouts. The measuring channels are electrically isolated from each other and are floating. The recorder is connected to transducers and to sensors such as thermocouples or resistance thermometers. Standard temperature sensor curves are stored in the firmware of the recorder and linearized with high accuracy.

In the version "Standard measuring range", the recorder is matched to the measuring task by means of keys of the display and control panel or via the RS-485 interface. The version "Universal measuring range" requires additional hardware matching by means of jumpers.

# 1 Installation and startup

## 1.1 Scope of delivery

(see figure 1)

The continuous-line recorder LINAX 4000M comes with:

- 1 copy of operating instructions

- 2 fasteners **Be**
- 1 fiber pen insert **Fe** per measuring channel
- 1 print insert **De** (Option)
- 1 pack of fanfold chart **Fp** or 1 roll chart **Sr**
- 24 jumpers for universal version
- Depending upon the order, the respective number of screw-plug terminals **Sk**, Sub-D plug, 9-pin, and reading ruler(s).

- Be** Fastener
- De** Print insert (Option)
- Fe** Fiber pen inserts
- Fp** Fanfold chart
- Sk** Screw-plug terminals
- Sr** Chart roll

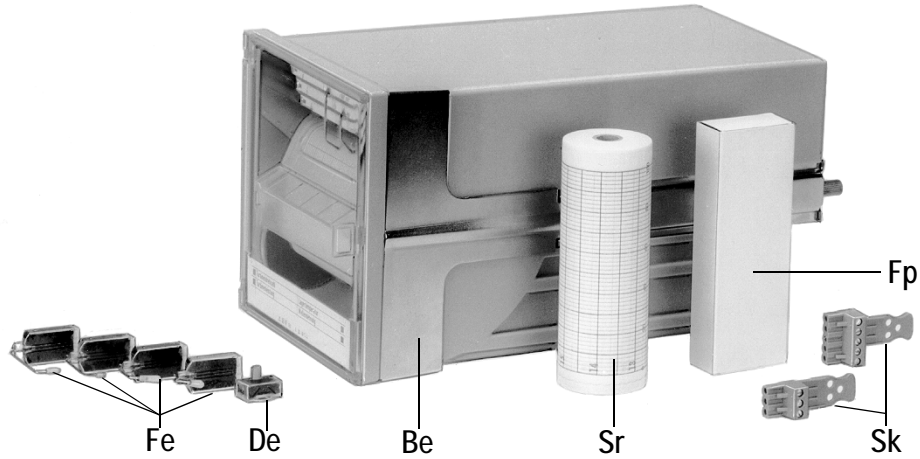

Figure 1 Scope of delivery of the LINAX 4000M

## 1.2 Selecting the mounting site

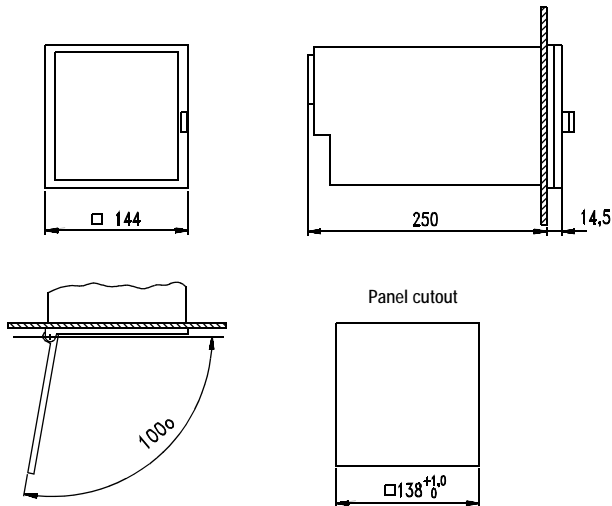

Figure 2 Dimensional drawing LINAX 4000M (dimensions in mm)

Position of use	Inclination to the side $-30^{\circ} \dots 0 \dots +30^{\circ}$ Inclination to the rear $20^{\circ}$ Inclination to the front $20^{\circ}$
Ambient temp.	$0 \dots 50^{\circ}\text{C}$
Relative humidity	$\leq 75\%$ annual average, max. $85\%$ . Prevent dewing!

## 1.3 Installation

(see figure 2 and figure 3)

### Installation in switchboards

1. Insert the recorder into the switchboard from the front.
2. At the sides of the case, slide the fasteners **Be** into the guide grooves (see figure 3).  
Note  
The fasteners **Be** are suited for side-by-side mounting in horizontal or vertical direction.
3. After aligning, equally tighten the fasteners **Be**.

Figure 3 Mounting the fasteners

## Installation in grid frames

1. Fasten 4 each centering angle bracket (Ordering number A416A) on the grid frame.
2. Slide the fasteners **Be** into the guide grooves at the sides of the case (see figure 3).
3. After alignment, equally tighten the fasteners **Be**.

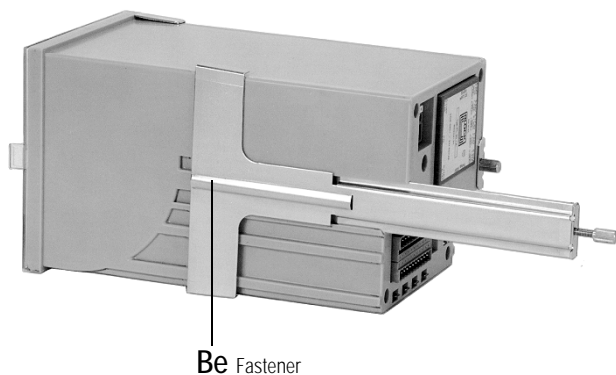

## 1.4 Connection

(see figure 4)

### ⚠ Caution

The connection between the protective conductor connection and a protective conductor must be made prior to all other connections.

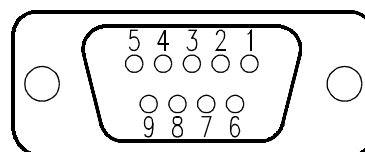
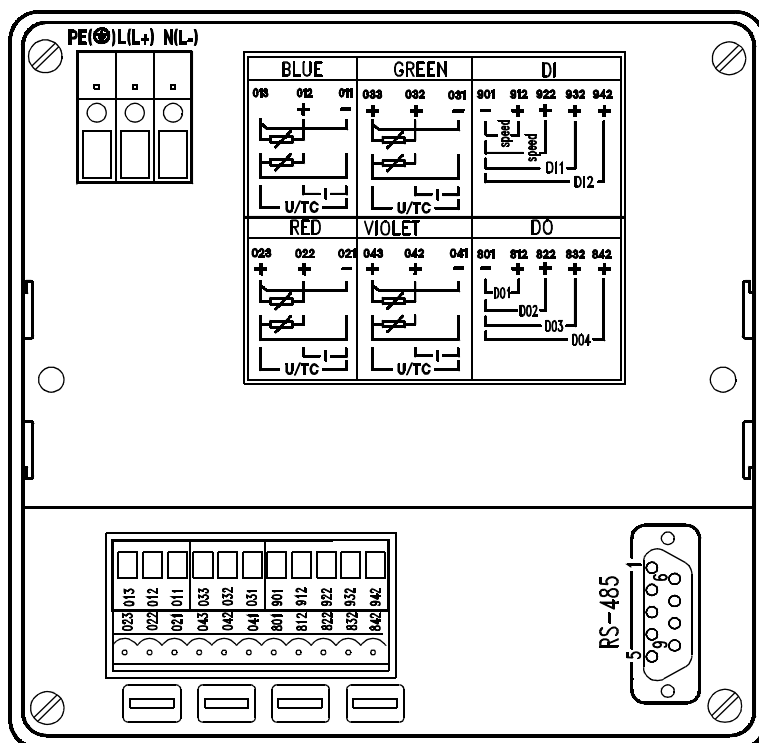

#### RS-485 interface

- Pin 1: Shield
- Pin 3: RXD (+)
- Pin 5: Gnd (reference potential)
- Pin 6: +5 V
- Pin 8: RXD (-)

#### For bus operation:

The voltage + 5V at pin 6 is required when the LINAX 4000M is used as bus end device.

The shield is attached to a plug-type connector on the recorder case.

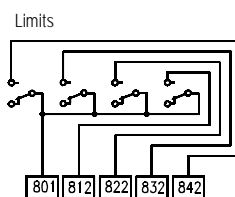
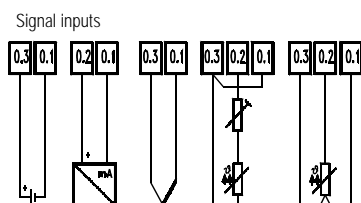

Chart speed circuit (terminals 901, 912, 922)  
Binary inputs = depending upon the parameterization  
for event markers / activation of text print  
(terminals 901, 932, 942)

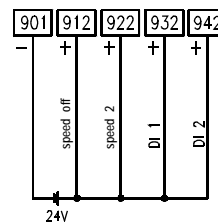

Figure 4 Rear panel and wiring diagrams

### 1.4.1 Connecting the input signals

- Fasten the signal leads in the screw-plug terminals, maximum cross section  $2 \times 1 \text{ mm}^2$ .

The recorder must only be operated in installed condition.

A power line connection switch of sufficient switching capacity, which permits all-pole disconnection of the recorder from the power line, must be provided within reach of the mounting site. It must not annul the protective effect of the protective conductor.

## 1.5 Chart loading

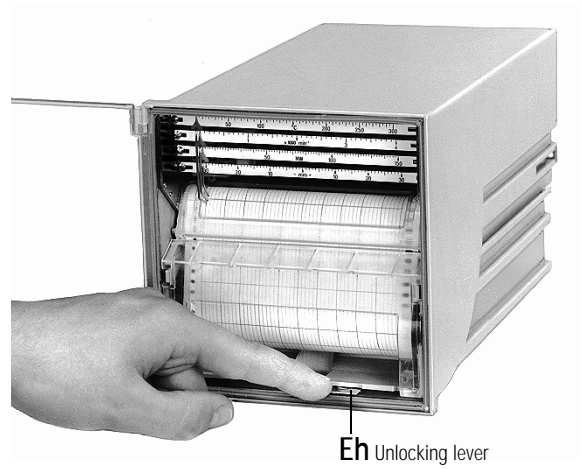

Figure 5 Unlocking the recording table

Ar Take-up roll  
 Ff Guide spring  
 Pa Paper holddown device  
 Pf Chart guide  
 Pm Chart compartment

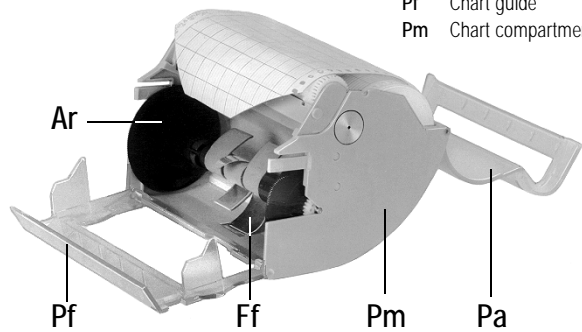

Figure 6 Recording table for roll chart

Pa Paper holddown device  
 Pf Chart guide  
 Pm Chart compartment

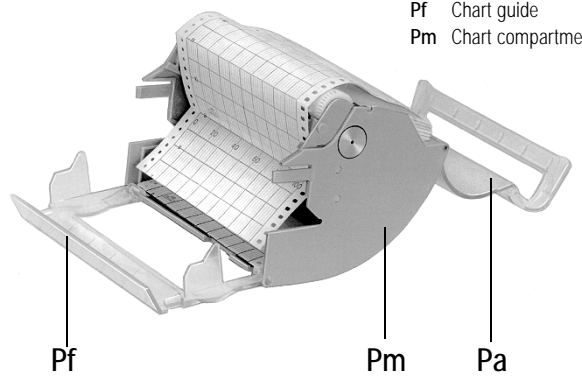

Figure 7 Recording table for fanfold chart

### 1.4.2 Connecting the power supply

- Fasten the power supply lines, max. cross section  $1 \times 4 \text{ mm}^2$  or  $2 \times 1.5 \text{ mm}^2$ , in the screw terminals. The cross section of the protective conductor must at least correspond to the cross section of the line power cable.

## 1.6 Installing the fiber pen insert / print insert

1. Fold the scales up.
2. Install the fiber pen insert / print insert according to figure 8.

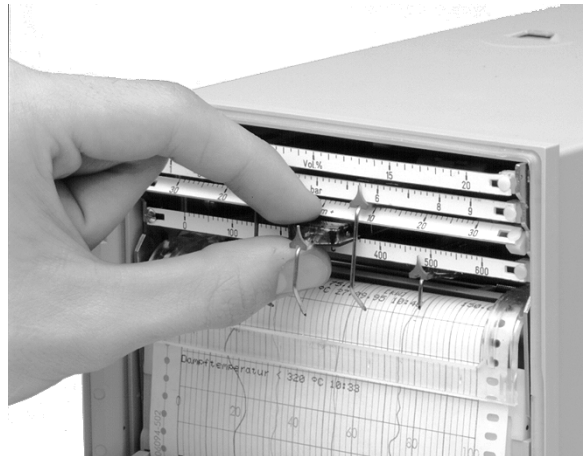

Figure 8 Installing the fiber pen insert / print insert

### 1.5.1 Recording table for roll chart

(see figure 5 and figure 6)

1. Unlock the recording table: Press the unlocking lever **Eh** downwards (see figure 5). The recording table tilts to the front. Remove the recording table.
2. Unfold the paper holddown device **Pa**.
3. Place the chart roll into the chart compartment **Pm**.
4. Pull the front end of the chart up to the pin platen and place the perforation onto the pins of the platen. Make sure chart and pin platen are in parallel!
5. Fold the paper holddown device **Pa** back.
6. Unfold the chart guide **Pf**.
7. Insert the take-up roll **Ar**
8. Fold the chart guide **Pf** back.  
**Note**  
When the recording table has been inserted into the recorder, the chart automatically winds onto the take-up roll.
9. Swing the recording table into the chassis until it engages.

### 1.5.2 Recording table for fanfold chart

(see fig. 5, fig. 6 and fig. 7)

When changing the recording table for roll chart to fanfold chart, remove the guide spring **Ff** (see figure 6).

1. Unlock the recording table: Press the unlocking lever **Eh** downwards (see figure 5). The recording table tilts to the front. Remove the recording table.
2. Unfold the paper holddown device **Pa**.
3. Place the fanfold pack into the chart compartment **Pm**.
4. Unfold the chart guide **Pf**.
5. Pull the front end of the chart up to the pin platen and place the perforation onto the pins of the platen. Two folded layers must rest on the bottom of the chart compartment. Make sure chart and pin platen are in parallel!
6. Fold the paper holddown device **Pa** back.
7. Fold the chart guide **Pf** back.
8. Swing the recording table into the chassis until it engages.

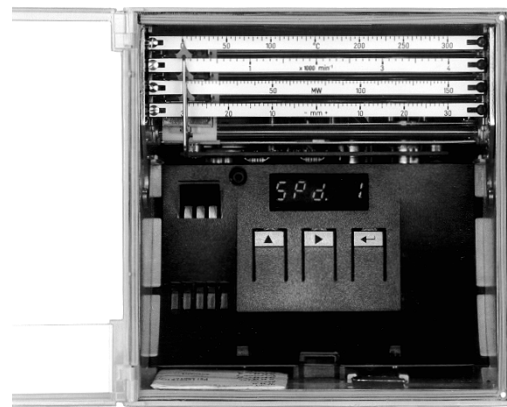

Figure 9 Display and control panel

It is easier to install the fiber pen inserts and the print insert when the recorder is switched on.

1. Unlock the recording table: Press the unlocking lever **Eh** downwards (see figure 5). The recording table tilts to the front.
2. Remove the recording table.
3. Press <▲>. The measuring systems travel to the park position.
4. Fold the scales up.
5. Install the fiber pen inserts and the print insert.
6. Fold the scales down.
7. Press <▶>.
8. Swing the recording table into the chassis until it engages.

## 1.7 Switching the recorder on

### **Caution**

Prior to switching the power supply on, verify that the operating voltage of the recorder (see nameplate) and the supply voltage agree.

A power line connection switch of sufficient switching capacity, which permits all-pole disconnection of the recorder from the power line, must be provided within reach of the mounting site. It must not annul the protective effect of the protective conductor.

Date and time are buffered via a capacitor (Super Cap). After longer periods without auxiliary voltage (e.g. when in stock), date and time are reset to a default value. At the next start, a note appears on the display (error message E150X). Date and time must then be set newly (see parameterizing instructions, ordering number 14083).

## 1.8 Positioning the recording chart

(see figure 10)

1. Press the lower grip boards of the recording table to the rear.  
The recording chart is transported with increased speed in the direction of flow.
2. Release the grip boards when the desired time line is reached.

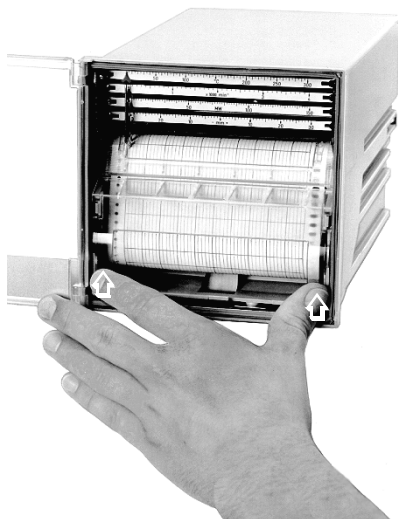

Figure 10 Positioning the recording chart

## 2 Operation

### 2.1 Removing the recording chart

(see figure 11)

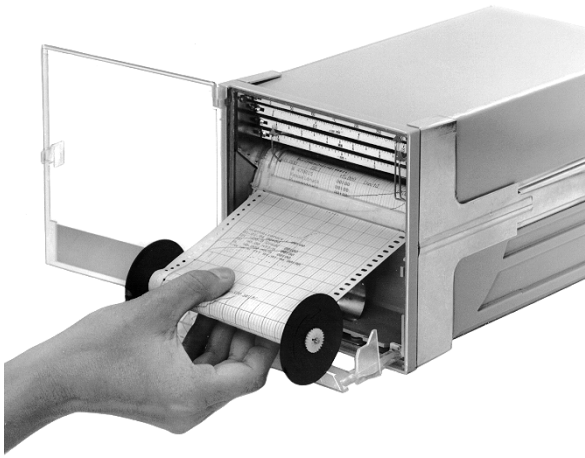

Figure 11 Removing the recording chart

## 2.2 Removing the rec. chart from the take-up roll

(see figure 12)



Figure 12 Removing the recording chart from the take-up roll

## 2.3 Changing the chart speed

When the recorder is fitted with the option "Limit monitor and binary inputs", two chart speeds are externally selectable. The desired values for speed 1 and speed 2 are selected in parameterization mode (see parameterizing instructions 14083).

Speed 1 is active after the recorder is switched on.  
Speed 2 becomes active by applying a voltage of 24 V DC between terminals 901 (-) and 922 (+).

The recording table may be left in the unit when removing the chart.

### Recording table for chart rolls

1. Unfold the chart guide downwards.
2. Remove the take-up roll.
3. Eventually separate the chart at the tear-off edge.

### Recording table for fanfold chart

1. Unfold the chart guide downwards.
2. Remove the recording chart.
3. Eventually separate the chart at a fold.

### Note

Two folded layers of the chart must rest in the chart compartment.

1. Turn the flange without drive pinion through 45° and remove it from the take-up roll.
2. Grip the chart as shown in figure 12 and pull it off the axle.
3. Re-attach the right flange to the take-up roll and secure it by turning it through 45°.
4. Insert the take-up roll into the recording table. The drive pinion must be on the right side.
5. Close the chart guide.

## 2.4 Standby function

When the recorder is fitted with the option "Limit monitor and binary inputs", the recorder can be switched to standby. This requires a voltage of 24 V DC to be applied between terminals 901 (-) and 912 (+).

In standby mode, the chart speed is switched off and is 1 mm/h (depending on the parameterization). The measuring systems are at the beginning of the scale. Processing of measured data and limit monitoring are active. When a limit is violated, or when the applied voltage is disconnected, the standby mode is inactivated. The recorder starts to record.



## 3 Reconfiguration

### 3.1 Changing measuring ranges

#### Standard version

In the version "Standard measuring range", the recorder is matched to the measuring task via keys of the display and control panel or via the RS-485 interface. See parameterizing instructions 14083.

#### Universal version

In the version "Universal measuring range", the recorder is matched to the measuring task via keys of the display and control panel or via the RS-485 interface. See parameterizing instructions 14083.

In addition, hardware matching by means of jumpers is required on the channel card.

#### 3.1.1 Hardware matching by means of jumpers (see figure 13))

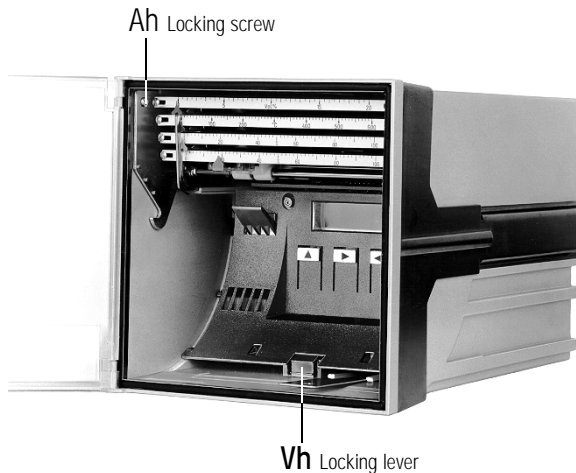

Figure 13

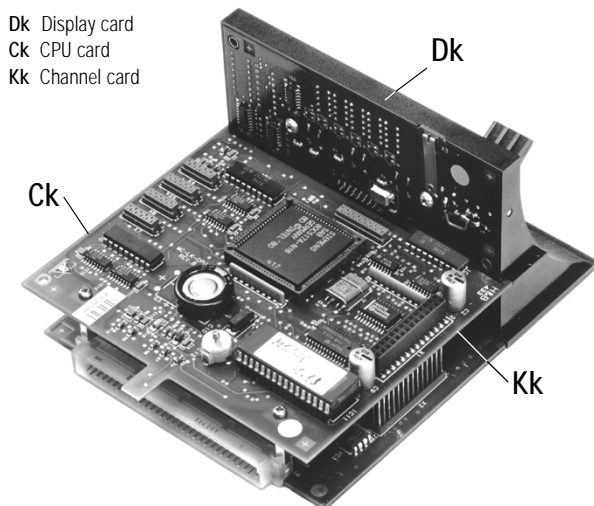

Figure 14 Electronic unit removed (rear view)

#### Removing the electronic unit

1. Undo the locking screw **As** (see figure 13) and pull the carrier of the measuring systems about 2 cm to the front.
2. Lift the locking lever **Vh** (see figure 13) and at the same time pull the assembly group to the front.

3. Unplug the plug to the measuring systems (max. 1...4) and the plug for the printer channel.
4. Remove the electronic unit (see figure 14).

#### Removing the channel card (lower circuit board)

1. Undo 4 screws **SI** (see figure 15).
2. Arrange the jumpers on the wiring side of the channel card in a channel-specific manner. Figure 16 shows the jumper fields that are assigned to the channels (X3...X6).
3. Arrange the jumpers in line with the desired measuring mode and the desired nominal measuring range (see figure 17).
4. Fasten the channel card **Kk** with the 4 screws **SI** (see figure 15).
5. Restore the plug connection to the measuring systems.
6. Insert the electronic unit into the recorder.
  - Securely engage the locking lever **Vh**.
7. Slide the carrier of the measuring systems into the case and tighten the locking screw **As** (see figure 13).
8. Switch the power supply on and parameterize the desired measuring ranges (see parameterizing instructions 14083).

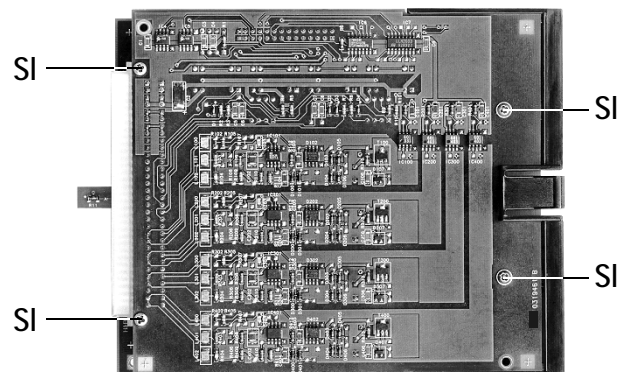

Figure 15 Undo the screws **SI** of the channel card (bottom view)

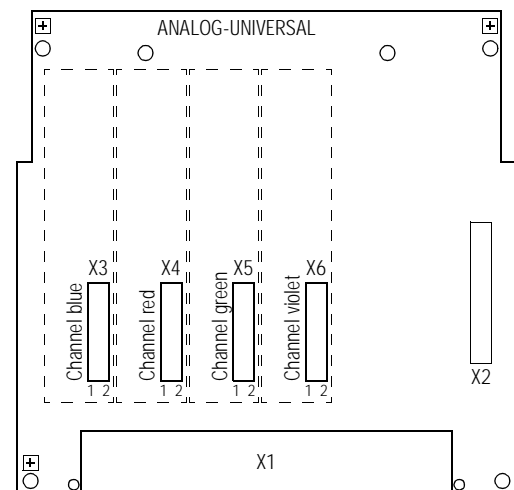

Figure 16 Arrangement of the jumper fields

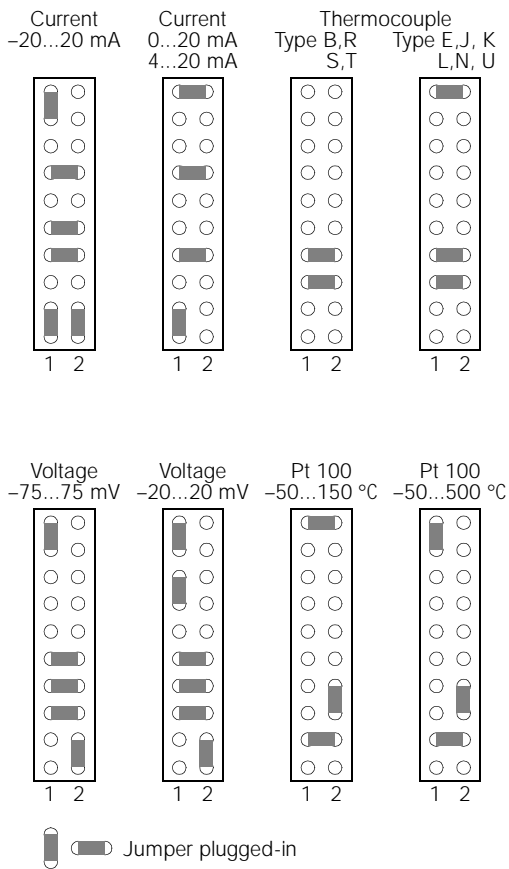

Figure 17 Arrangement of jumpers as a relation of measuring mode and nominal measuring range

### 3.2 Replacing scales

(see figure 18)

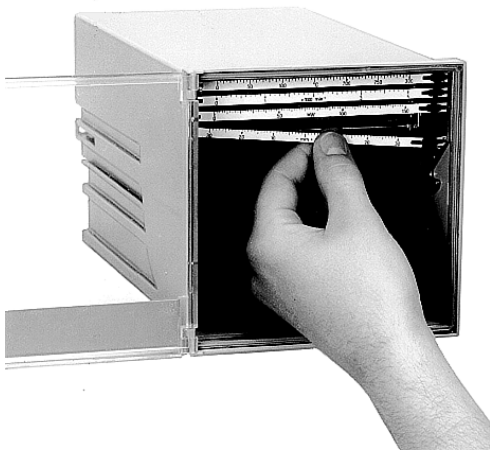

Figure 18 Replacing scales

1. Withdraw the fiber pen inserts.
2. Undo the scale screws at left.
3. Slide the scales to the right and disengage them from the scale screw.
4. Remove the scales to the left.
5. Install the scales in reverse order.
6. Install the fiber pen inserts.

7. Check the measuring system zero with beginning of scale.
  - a. Remove the recording table.
  - b. Press <J>. "SYS" is displayed.  
The measuring systems travel to electrical zero.
  - c. Align scale with pointer and tighten the scale screw.
  - d. Insert the recording table.

### 3.3 Replacing the label for the measuring points

(see figure 19)



Figure 19 Replacing the label for the measuring points

- Remove the flexible label for the measuring points from its holder and replace it with a new one.

## 4 Maintenance

### 4.1 Fuse replacement

(see figure 20)

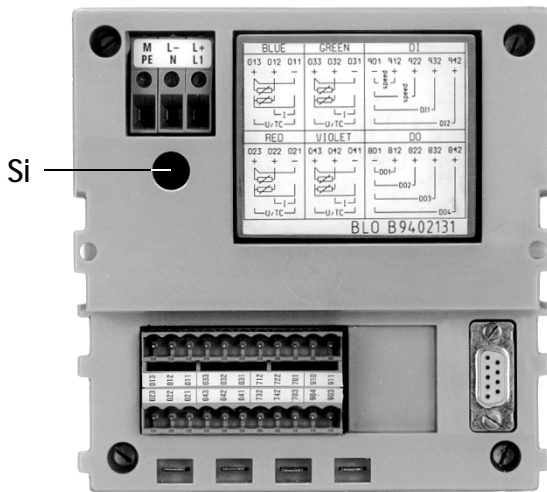

Figure 20 Replacing fuse Si

### Caution

Make sure that replacement fuses are of the specified type and the specified nominal current rating only. The use of mended fuses or shorting of the fuse holder is not permissible.

Live parts can be exposed when opening covers or removing parts, except where this is possible manually. Also connection points may be live.

1. Unscrew the fuse holder.
2. Replace fuse Si with a new one.
3. Replace the fuse holder.

#### Fuse values

230 V	M 0.16 C
115 V	M 0.315 C
24 V	M 1.6 E

## 5 Technical data

### Applied rules and standards

#### A) International standards

IEC 484	Potentiometric recorders
IEC 1010-1	Electrical safety (test voltages)
IEC 664	Overvoltage category, degree of pollution
IEC 66-2-6	Mechanical stress (vibrations)
IEC 68-2-27	Mechanical stress (shock)
IEC 529	Degrees of protection provided by enclosures
IEC 801, EN 60801	Immunity to interference of electromagnetic influences
EN 55011	Radio interference suppression
EN 61010	Safety requirements of measurement and control equipment
IEC 721-3-3	Climatic environmental conditions
IEC 742	Classification VDE 0551 safety transformers

#### B) German standards

DIN 43802	Scales
DIN 16234	Recording paper
DIN 43831	Cases

### Symbols and their meaning

Symbol	Meaning
X1n / X1	Lower range limit nominal range / lower range limit
X2n / X2	Upper range limit nominal range / upper range limit
X2n – X1n / X2 – X1	Range span nominal range / range span

### Analog inputs

#### Standard version

DC current	0...20 mA; Ri = 50 Ω 4...20 mA; Ri = 50 Ω ± 20 mA; Ri = 50 Ω
DC voltage	± 10 V; Ri = 1 MΩ

#### Universal version

DC current	0...20 mA; Ri = 50 Ω 4...20 mA; Ri = 50 Ω ± 20 mA; Ri = 50 Ω
DC voltage	± 10 V; Ri = 1 MΩ
DC voltage	± 10 V; Ri = 1 MΩ ± 60 mV; Ri ≥ 2 MΩ
Thermocouples, Ri ≥ 2 MΩ	Type T 0 ... +400 °C Type J 0 ... +1200 °C
Thermocouples, Ri ≥ 2 MΩ	Type L 0 ... +900 °C Type K 0 ... +1372 °C Type E 0 ... +1000 °C Type S 0 ... +1769 °C Type R 0 ... +1769 °C Type B 100 ... +1820 °C  Cold junction compensation internally or externally parameterizable
Resistance thermometer Pt 100	–50 ... +500 °C; –50 ... 150 °C
With 2-wire connection	Lead resistance 10 Ω max.
With 3-wire connection	Lead resistance 40 Ω max.

Lower range limit parameterizable from X1n ... X1n + 0.8 (X2n – X1n) and range span parameterizable from 0.2 (X2n – X1n) ... (X2n – X1n).

Deadband 0.25 % of range span

Setting time 2 s

Attenuation of the meas. value with low-pass filter of 1st order; Time constant 0 ... 60 s per measuring channel, can be parameterized.

Root-extraction function can be parameterized with DC current and DC voltage measuring ranges.

### Accuracy

Deviation for line channels according to IEC 484	Class 0.5 referred to range span
With displacement of lower range limit and/or upper range limit additionally	$\pm 0.1 \% \times \frac{X1}{X2 - X1}$ [mV; mA; Ω]
Data recording with printer system according to IEC 484	Class 1 referred to range span
With internal cold junction compensation	± 4 K, additionally

### Variations

Temperature	0.2 % / 10 K, additionally 0.1 % / 10 K with conn. to thermocouple
Humidity	Note infl. on rec. paper acc. to DIN 16234
Auxiliary voltage Hn	0.1 % at 24 V DC ± 20 % 0.1 % at 24 V AC +10 % / –15 % 0.1 % at 110 V AC +10 % / –15 % 0.1 % at 230 V AC +10 % / –15 %
AC interference voltages (see perm. interference voltages)	0.5 % of range span
Magnetic field of external origin 2 mT	0.5 % of range span
Mechanical stress according to DIN IEC 68-2-6/27 Transport Impact: 30 g/18 ms Vibration: 2 g/5 ... 150 Hz In function Vibration: 0.5 g/± 0,04 mm/ 5...150 Hz/3 × 2 cycles	During and after the effect ± 0.5 % of range span

### Reference conditions

Ambient temperature	25 °C ± 1 K
Relative humidity	45 ... 75 %
Auxiliary voltage	Hn ± 2 %, nominal frequency ± 2 %
Mounting position	Front upright ± 2°
Warm-up time	30 min

### Binary inputs

Number	4
Designation	speed 2, speed off, DI 1, DI 2
Auxiliary voltage	DC 20 ... 24 ... 30 V
Input current	6 mA
H signal	20 ... 30 V
L signal	0 ... 1.3 V

### Outputs for limit monitors (option)

Four potential-free relay contacts (connected with each other on one side), contact load 30 VA / 100 mA.

Two limits per channel for absolute value monitoring. The four internal relays can freely be correlated with the limits. Hysteresis 2 % of range span.

### Event markers (option)

Only for version with printer channel

Two markers possible

Recording at approx. 2 % and 5 % of the recording width

Control voltage 24 V DC / 6 mA, external

## Display

### Scale

- One graduation per measuring system
- Scale face 5 mm wide
- Character size 2 mm





### Control and display table (only for parameterizing)

- Display
- 5-digit 7-segment display
- Size of characters 4 × 7 mm
- Operation via 3 keys

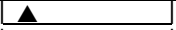

## Recording

### Arrangement of measuring systems and color correlation

#### Version without printer channel

		1	2	3	4	No. of line channels
	green			x	x	
	red		x	x	x	
	blue	x	x	x	x	
	violet				x	

#### Version with printer channel

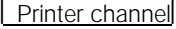
		1	2	3		No. of line channels
	green			x		
	red		x	x		
	blue	x	x	x		
	violet					

#### 1. Line recording

Fiber recording pen with inkwell of approximately 1.4 ml, line length approximately 1300 m, distance between the tips of the fiber recording pens 2 mm.

#### 2. Printing

A printer system for printing of texts can be installed in place of the lower measuring system. Distance between blue fiber pen and print head 6 mm.

In addition to the text printout, a measured value can be recorded with the printer system.

Recording of the measured value is made in the form of a dotted line with equidistant dot spacing.

Color supply of the print head approx.  $1.5 \times 10^6$  dots.

#### Text printout for:

- Eight text lines of 16 characters each.  
Each text line is supplemented with time printout. Cyclic initiation, in parameterizable intervals or event-depending by internal limits or external stimulation (binary inputs).
- Printout of chart speed, date and time.  
Initiation with recorder ON and with a change in chart speed.
- Printout of time and date.  
Cyclic initiation, in parameterizable time intervals or event-depending by external stimulation.
- Printout of actual measured values  
Cyclic initiation, in parameterizable time intervals or event-depending by internal/external stimulation.
- Printout of double lines correlated with the individual measuring points.  
First line:  
Scaling line with channel designation and printout of the unit.  
Second line:  
Text specific to the measuring point, max. 32 characters.
- Listing of all active parameters  
Manual initiation in parameterizing mode.

### Text printout/recording

Maximum possible chart speed	240 mm/h
Size of characters	ca. 1.5 × 2 mm
Chart speed	2 chart speeds can be parameterized in mm/h: 0/2,5/5/10/20/60/120/240/300/600/1200; can be changed-over and disconnected externally (24 V DC/6 mA)
Recording chart	32 m roll chart or 16 m fanfold chart
Visible chart length	60 mm
Recording width	100 mm (chart width 120 mm, DIN 16230)
Chart intake (with roll chart)	Via automatic paper take-up device (daily tear-off or wind-up of the 32 m possible)

## Auxiliary voltage

24 V DC ± 20 % or

24/115/230 V AC +10 %/-15 %

Frequency range 47.5 ... 63 Hz

Power consumption with max. fitting approx. 20 W/27 VA

## RS-485 interface (optionally RS-232 with adapter)

a) For parameterizing

b) Linking to host systems for bidirectional data transmission.  
Data protocol with reference to the PROFIBUS standard.

## Climatic suitability

Ambient temperature	0 ... <u>25</u> ... 50 °C
Transport and storage temperature	-40 ... +70 °C
Relative humidity	≤ 75 % annual average max. RH ≤ 85 % in function
Climatic class	3K3 acc. to IEC 721-3-3

## Electrical safety

Test according to DIN EN 61010-1 (classification VDE 0411) and/or IEC 1010-1

Protection class I

Overvoltage category III at the power input and degree of pollution 2 according to VDE 0110 parts 1 and 2

Test voltage

3.75 kV measuring channels to energy supply

2.20 kV protective conductor to energy supply

## Functional extra low voltage with protective isolation (PELV according to DIN EN 60950)

Between power input – measuring channels, control leads, interface cables acc. to VDE 0100 part 410 and VDE 0106 part 101

## Electromagnetic compatibility

The protection goals of the EMC directive 89/336/EWG as to radio interference suppression according to EN 55011 and as to immunity to interference according to EN 50082-2 are complied with.

Radio interference suppression

Limit class B according to EN 55011 and/or

Post Office decree 243/92.

Immunity to interference: Test according to IEC 801

Type of test	Test severity	Variation	Severity level
ESD (1/30 ns)	6 kV	≤ 1 %	3
HF field			
Radiated 25 MHz ... 1 GHz	10 V/m	≤ 1 %	3
Line-guided 0.15 ... 80 MHz	10 V	≤ 1 %	3
Burst (5/50 ns) on			
Power line	2 kV	≤ 1 %	3
Test lead	1 kV	≤ 1 %	3
Surge (1.2/50 μs) on			
Power line common	2 kV	≤ 1 %	3
differential	1 kV	≤ 1 %	2
1 MHz pulse on			
Power line common	2 kV	≤ 1 %	3
differential	1 kV	≤ 1 %	3

The NAMUR industry standard EMC is met (Interface cables shielded).

Permissible interference voltages

Perm. interference voltage	Standard version	Universal version
Series mode interference voltage peak-to-peak	≤ 0.3 × meas. span max. 3 V	≤ 3 × meas. span max. 3 V
Push-pull rejection	35 dB	35 dB
Common mode interference voltage	60 V DC/42 V AC	60 V DC/42 V AC
Common mode rejection	70 dB	70 dB

### Default parameter setting

If individual parameter setting is not specified when ordering a recorder, the LINAX 4000M is delivered with the following default parameter setting:

All measuring channels with 0 ... 20 mA measuring range  
 Chart speed 1: 20 mm/h  
 Chart speed 2: 120 mm/h  
 Chart speed 3: Off  
 Limits are set to end positions (0 and 20 mA).  
 Attenuation of measured value, zoom, printer and limit functions are switched off.  
 No password entered.  
 This default parameter setting can be re-initialized independent of the actually set parameters.

### Connection, case and installation

Electrical connections

Protection type IP 20  
 Screw-plug terminals for signal inputs, control inputs and limit relay outputs  
 Max. wire cross section 2 x 1 mm<sup>2</sup>  
 Screw terminals for line connection  
 Max. wire cross section 4 mm<sup>2</sup>  
 RS-485 interface via 9-pin SUB-D plug

Case

Molded material for installation in panels or mechanical grids (see dimensional drawing for dimensions)

Protection type of case according to DIN 40050

IP 54 for the front  
 IP 20 for the rear

Color of case

Silica-gray according to RAL 7032

Door of case

Molded material

Fastening of case

With 2 fasteners (optionally for installation in panel or mechanical grid), centering angle brackets are required for installation in mechanical grids, (Ordering Number A416A)

Position of use

Inclined to the side [-30° ... 0 ... +30°]  
 Inclined to the rear 20°  
 Inclined to the front 20°

Mounting distance

Horizontal or vertical 0 mm, it must be possible to open the door of the case through 100°

Weight

3.5 kg, approx.

## 6 Packing

The fiber pen inserts must be removed before the recorder is transported.

If the original packaging material is no longer available, wrap the recorder in air-cushion foil or corrugated paper and pack it in a sufficiently large crate which is lined with shock-absorbing material (foam rubber or similar material). The thickness of the padding must be matched to the weight of the device and the type of packaging. The crate must be marked "Fragile".

When shipped overseas, air-tight welding of the recorder into a 0.2 mm thick polyethylene foil which contains a drying agent is additionally required. The quantity of the drying agent is to be chosen in line with the packaging volume and the expected duration of the transport (at least 3 months). The crate must additionally be lined with a layer of double bituminous paper.

---

Printed in Germany • Subject to change without notice

GOSSEN-METRAWATT GMBH  
D-90327 Nürnberg

Company address:  
Thomas-Mann-Straße 16-20  
D-90471 Nürnberg  
Telefon (0911) 8602-0  
Telefax (0911) 8602-669

