

# Operating Instructions

2/10.22

3-447-121-03



## ENERGYMID

MULTIFUNCTIONAL ENERGY METERS

EM2281, EM2289 – DIRECT CONNECTION

EM2381, EM 2387, EM2389 – TRANSFORMER CONNECTION

# CONTENTS

<b>1</b>	<b>Safety Instructions</b> .....	<b>5</b>
<b>2</b>	<b>Applications</b> .....	<b>6</b>
2.1	Intended Use / Use for Intended Purpose .....	6
2.2	Use for Other than Intended Purpose .....	6
2.3	Liability and Guarantee .....	6
<b>3</b>	<b>Documentation</b> .....	<b>7</b>
3.1	Information Concerning these Instructions .....	7
3.2	Identification of Warnings .....	7
3.3	Identifiers .....	8
3.4	Definition of Terms .....	8
<b>4</b>	<b>Getting Started</b> .....	<b>9</b>
<b>5</b>	<b>The Instrument</b> .....	<b>10</b>
5.1	Scope of Delivery .....	10
5.2	Optional Accessories .....	10
5.3	Instrument Overview .....	10
5.3.1	Front .....	10
5.3.2	Side View .....	11
5.4	Dimensional Drawing .....	11
5.5	Tamper-Proof Sealing .....	12
5.6	Connections .....	12
5.7	Symbols on the Instrument and the Included Accessories .....	13
5.8	Relevant Standards, Regulations and Directives .....	14
5.9	Technical Data .....	15
5.10	Characteristic Values .....	18
5.10.1	Measuring ranges .....	18
5.10.2	Inputs, outputs and interfaces .....	18
5.10.3	Tariff Inputs .....	18
5.10.4	Pulse Outputs .....	18
5.10.5	Bus Interfaces .....	19
5.10.6	Block Diagram for Safety Specification .....	20
5.11	OBIS Figures .....	20
<b>6</b>	<b>Initial Startup</b> .....	<b>21</b>
6.1	Unpacking .....	21
6.2	Installation .....	21
6.2.1	Mounting .....	22
6.2.2	Connection .....	23
6.2.3	Display of Connection Errors and Troubleshooting .....	28
6.2.4	Sealing .....	28
6.3	Connection to Your Equipment (interfaces) .....	28
6.3.1	LON Installation (feature W1) .....	28
6.3.2	M-Bus Installation (feature W2) .....	29
6.3.3	TCP/IP – BACnet, Modbus TCP, HTTP (feature W4) .....	29
6.3.4	Modbus RTU (feature W7) .....	29

<b>7</b>	<b>Display and Operation</b> .....	<b>30</b>
7.1	Display .....	30
7.2	Test LEDs .....	32
7.3	Keys .....	32
7.3.1	UP and ENTER .....	32
7.3.2	Enable Key .....	33
<b>8</b>	<b>Configuration and Operation</b> .....	<b>34</b>
8.1	Display of Active and Reactive Energy, as well as Active and Reactive Power .....	35
8.1.1	Displaying Inductive Reactive Energy and Reactive Power (only with feature M2/M3) .....	35
8.1.2	Displaying Active Energy and Active Power Export.....	35
8.1.3	Displaying Capacitive Reactive Energy and Reactive Power (only with feature M2/M3).....	35
8.1.4	Displaying Total Active Energy Import (all) and Reactive Energy Import (only with feature M2/M3).....	36
8.1.5	Displaying Total Active Energy Export (all) and Reactive Energy Import (only with feature M2/M3).....	36
8.2	Switching Amongst Tariffs.....	36
8.2.1	Displaying Active Energy and Reactive Energy (only with feature M2, M3) .....	36
8.2.2	Displaying Total Active Energy and Total Reactive Energy Import (only with feature M2, M3) .....	38
8.3	Power Displays (feature M1/M3 only) .....	40
8.3.1	4-Wire Displays.....	40
8.3.2	3-Wire Displays.....	41
8.3.3	2-Wire Displays.....	41
8.4	Mains Monitor (only with feature M1/M3).....	42
8.4.1	4-Wire Displays.....	42
8.4.2	3-Wire Displays.....	43
8.4.3	2-Wire Displays.....	43
8.5	S0 Pulse Output (only with feature W0) .....	44
8.5.1	Displaying Pulse Frequency .....	44
8.5.2	Adjusting Pulse Frequency (only with feature V2, V4).....	44
8.5.3	Displaying Pulse Duration.....	45
8.5.4	Adjusting Pulse Duration (only with feature V2, V4).....	45
8.5.5	Displaying the Pulse Source.....	45
8.5.6	Selecting Pulse Sources (only with feature V2, V4) .....	46
8.6	Transformation Ratio (EM2381, EM2387 and EM2389 only) .....	47
8.6.1	Displaying the Current Transformation Ratio (CT) .....	47
8.6.2	Setting the Current Transformation Ratio (CT) (only with feature Q1) .....	47
8.6.3	Displaying the Voltage Transformation Ratio (VT).....	47
8.6.4	Setting the Voltage Transformation Ratio (VT) (only with feature Q1).....	48
8.7	Bus Connections (features W1, W2,W4, W7) .....	49
8.8	Meter Reading Profile.....	49
8.8.1	Meter Reading Profile Z1.....	49
8.8.2	Meter Reading Profile Z2.....	50
8.9	Firmware Version .....	51
8.10	Display Test .....	51
8.11	Calibration Display .....	52
8.11.1	Activating the Calibration Display .....	52
8.11.2	Pinned Calibration Display / Live Values .....	52

---

<b>9</b>	<b>Error .....</b>	<b>53</b>
9.1	Power Failure .....	53
9.2	Fault Conditions and Troubleshooting .....	53
<b>10</b>	<b>Maintenance .....</b>	<b>54</b>
10.1	Cleaning .....	54
10.2	Recalibration .....	54
10.3	Repairs .....	56
<b>11</b>	<b>Removal from Service and Dismantling .....</b>	<b>57</b>
11.1	Disconnection from the Power Supply .....	57
11.2	Dismantling .....	58
<b>12</b>	<b>Transport and Storage .....</b>	<b>59</b>
<b>13</b>	<b>Contact, Support and Service .....</b>	<b>60</b>
<b>14</b>	<b>Disposal and Environmental Protection .....</b>	<b>61</b>
<b>15</b>	<b>Certifications .....</b>	<b>62</b>
15.1	CE Declaration .....	62
15.2	Calibration Certificate (with feature P9 only) .....	62
15.3	Prototype Test Certificate .....	62
15.4	National Declaration of Conformity .....	62

# 1 SAFETY INSTRUCTIONS



Read and follow these instructions carefully and completely in order to ensure safe and proper use.

Keep for future reference.

## General

- Carefully and completely read and adhere to these operating instructions. The respective document can be found at <http://www.gossenmetrawatt.com>. Retain the document for future reference.
- The instrument may only be used for the measurements described in the documentation for the instrument.

## Work Performed on the Instrument

- Work performed on the instrument may only be carried out by a qualified electrician.
- Wear suitable and appropriate personal protective equipment (PPE) whenever working with the instrument.
- Observe and comply with all safety regulations which are applicable for your work environment.
- The respective system, as well as all connection cables and leads, must be voltage-free before any work is performed on the instrument.
- When performing work on the instrument, observe the five safety rules in accordance with DIN VDE 0105-100, Operation of electrical installations – Part 100: General requirements (1. Shut down entirely. 2. Secure against restart. 3. Assure absence of voltage at all poles. 4. Ground and short circuit. 5. Cover neighboring live components, or make them inaccessible.).

## Operation

- Only operate the instrument if it's in good working order. Inspect the instrument at regular intervals. Pay particular attention to damage.
- Connection cables and leads must be damage-free. Inspect connection cables and leads at regular intervals. Pay particular attention to damage, interrupted insulation or kinked cables.
- The instrument may only be operated in environments which comply with the specified technical data and conditions (ambient conditions, IP protection code, measuring category, nominal voltage etc.).
- The instrument must not be exposed to direct sunlight.
- Do not operate the instrument in potentially explosive atmospheres.
- If the instrument doesn't function flawlessly, permanently remove it from operation and secure it against inadvertent use.

## Data Security and Protection

- The instrument determines values with relevance for billing. Observe and comply with currently valid regulations for data security and protection.

---

## 2 APPLICATIONS

---

Please read this important information!

### 2.1 INTENDED USE / USE FOR INTENDED PURPOSE

ENERGYMID EM2281, EM2289, EM2381, EM2387 and EM2389 instruments are multifunctional energy meters (certified in accordance with MID – Measuring Instruments Directive 2014/32/EU).

They're used for the acquisition and billing of active energy, e.g. in industrial, household, commercial and building management applications. Integrated 4-quadrant measurement permits measurement of energy import and export. 4 tariffs (hardware-controlled as standard feature) and, depending on model or version, 4 additional tariffs (software-controlled) can be selected.

Thanks to MID certification, acquired data (display) can also be used for the purpose of billing energy costs to third parties.

- EM2281 (article no. U2281): for 2 wire system, 230 V, direct connection, 5(80) A
- EM2289 (article no. U2289): for 4-wire system, any load, direct connection, 5(80) A
- EM2381 (article no. U2381): for 2 wire system, 230 V, transformer connection 1(6) A (including 5(6) A)
- EM2387 (article no. U2387): for 3-wire system, any load, transformer connection, 1(6) A (including 5(6) A)
- EM2389 (article no. U2389): for 4-wire system, any load, transformer connection, 1(6) A (including 5(6) A)

Technical properties and other functions are defined via configurable features (e.g. pulse output, type of bus connection and meter reading profile). This results in individualized, device-specific variants when placing orders. Refer to the data sheet and your order for your instrument variant and its features.

All instruments include measures for protection against tampering (tamper-proof cover and configuration disabling).

Values are also forwarded to superordinate management systems via feature-dependent communication interfaces, e.g. for acquisition and optimization, as well as for building automation and control technology).

ENERGYMID energy meters are ideally suited for use with other components included in GOSSEN METRAWATT's Energy Control System (ECS) for the implementation of comprehensive systems for energy data collection: data from ENERGYMID energy meters can be retrieved by means of summators and data loggers, e.g. the SU1604 or SMARTCONTROL, and can be consolidated in energy management software, e.g. EMC 5.x. All relevant consumption data can then be archived, displayed, analyzed and billed.<sup>1</sup>

Safety of the operator, as well as that of the instrument, is only assured when it's used for its intended purpose.

### 2.2 USE FOR OTHER THAN INTENDED PURPOSE

Using the instrument for any purposes other than those described in the condensed operating instructions or these instrument operating instructions is contrary to use for intended purpose.

### 2.3 LIABILITY AND GUARANTEE

Gossen Metrawatt GmbH assumes no liability for property damage, personal injury or consequential damage resulting from improper or incorrect use of the product, in particular due to failure to observe the product documentation. Furthermore, all guarantee claims are rendered null and void in such cases.

Nor does Gossen Metrawatt GmbH accept any liability for data loss.

---

1. Refer to <https://www.gmc-instruments.de/en/> for information concerning additionally available components.

## 3 DOCUMENTATION

### 3.1 INFORMATION CONCERNING THESE INSTRUCTIONS

Read these instructions attentively and carefully. They include information which protects your and others from injury, and prevents damage to the instrument.

#### Descriptions of Instrument Variants

This documentation describes the following instruments and their variants: ENERGYMID EM2281, EM2289, EM2381, EM2387 und EM2389.

As a result, features and functions may be described which do not apply to your instrument. Furthermore, images may differ from your instrument or represent only one of several possible variants. Illustrations must therefore be regarded as representative examples.

#### Errors and Suggestions for Improvement

These instructions have been prepared with utmost care in order to ensure correctness and completeness. Unfortunately, errors can never be entirely avoided. Continuous improvement is part of our quality goal, so we always appreciate your comments and suggestions.

#### Gender Equality

For better readability, only the masculine form is used in these instructions in a grammatically impartial sense. The female and diverse forms are of course always implied as well.

#### Trademark Law

Product designations used in this document may be subject to trademark law, brand law and patent law. They are the property of their respective owners.

#### Copyright

This document is protected by copyright. Content modifications, reproduction, duplication, processing or translation in any form (including excerpts) are only permissible after obtaining written permission from Gossen Metrawatt GmbH. This applies in particular to storage and processing in electronic systems.

### 3.2 IDENTIFICATION OF WARNINGS

Instructions for your safety and for the protection of the instrument and its environment are provided as warnings and notes at certain points within these instructions. They're laid out as shown below and are graded in terms of the severity of the respective hazard. They also describe the nature and cause of the hazard and what must be done to avoid it.

	<b>DANGER</b>
Death or serious injury is almost certain.	

	<b>WARNING</b>
Death or serious injury is possible.	

	<b>CAUTION</b>
Minor or moderate injury is possible.	

<b>ATTENTION</b>
Damage to the product or the environment is possible.

**Note**

Important information

**Tip**

Useful additional information or application tip

### 3.3 IDENTIFIERS

The following identifiers are used in this documentation:

Identifier/Symbol	Meaning
<b>Control Element</b>	Keys, buttons, menus and other controls
✓ Prerequisite	A condition etc. which must be fulfilled before a given action can be taken
▶ <b>Procedure</b>	Beginning of a procedural instruction
1. Procedural step	Steps of a procedure which must be completed in the specified order
↳ Result	Result of a procedural step
■ Enumeration	Bullet lists
• Enumeration	
<i>Figure 1: Caption</i>	Description of the content of a figure
<i>Table 1: Table 1:</i>	Description of the content of a table
Footnote	Comment

### 3.4 DEFINITION OF TERMS

Instrument	Energy meters ENERGYMID EM2281, EM2289, EM2381, EM2387 und EM2389.
Feature	Product feature (e.g. bus connection type, pulse output, measurement of reactive energy) – used to configure the instrument variant and is specified when the order is placed
Meter reading profile	A series of meter readings taken every 15 minutes with a discrete time interval and a time-stamp Feature Z1: Adjustable time interval Feature Z2: Fixed time interval, every 15 minutes (in accordance with PTB-A 50.7 and PTB-A 50.7-1) – with operating logbook and calibration logbook (recorded for 4 years)



---

## 4 GETTING STARTED

---

1. Read and adhere to the product documentation. In particular observe all safety information in the documentation, on the tester and on the packaging.
  - Safety Instructions ⇨ 5
  - Applications ⇨ 6
  - Documentation ⇨ 7
2. Familiarize yourself with the instrument and its features ⇨ 10.
3. Start up the instrument ⇨ 21.
4. Familiarize yourself with the display and instrument operation ⇨ 30.
5. Configuration and operation ⇨ 34:
  - Display of active and reactive energy, as well as active and reactive power ⇨ 35
  - Switching amongst tariffs ⇨ 36
  - Power displays (feature M2/M3 only) ⇨ 40
  - Mains monitor (only with feature M1/M3) ⇨ 42
  - S0 pulse output (only with feature W0) ⇨ 44
  - Transformation ratio (EM2381, EM2387 and EM2389 only) ⇨ 47
  - Bus connections (features W1, W2, W4, W7) ⇨ 49
  - Meter reading profile ⇨ 49
  - Firmware version ⇨ 51
  - Display test ⇨ 51
  - Calibration display ⇨ 52

Further topics of interest: Maintenance ⇨ 54

## 5 THE INSTRUMENT

### 5.1 SCOPE OF DELIVERY

Please check for completeness.

- 1 Energy meter
- 2 Condensed operating instructions (German, English)
- 1 Calibration certificate (with feature P9 only)

### 5.2 OPTIONAL ACCESSORIES

U270B Door mounting kit for energy meter, 4 or 7 standard width units

### 5.3 INSTRUMENT OVERVIEW

#### 5.3.1 FRONT

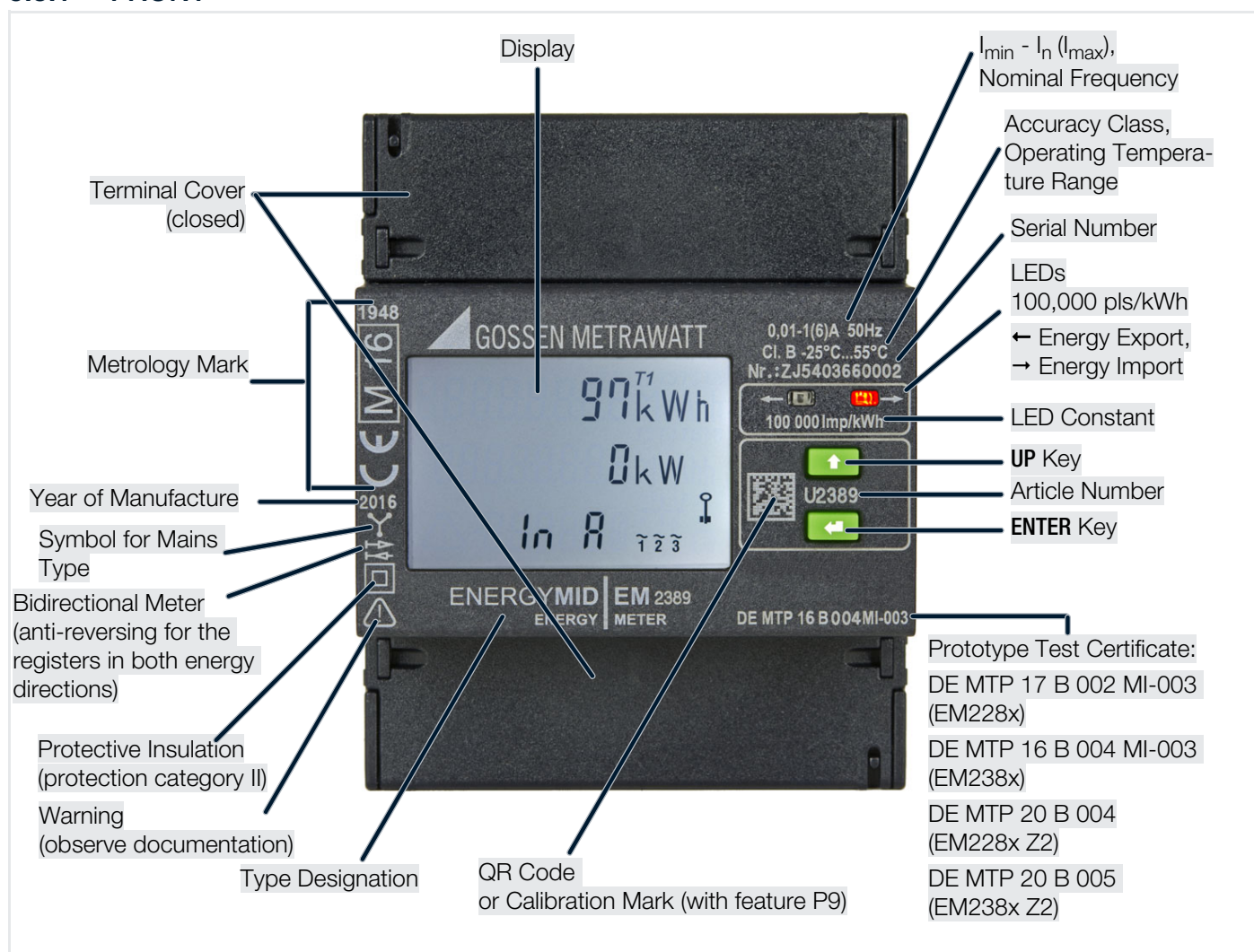

Figure 6: Front Panel

### 5.3.2 SIDE VIEW

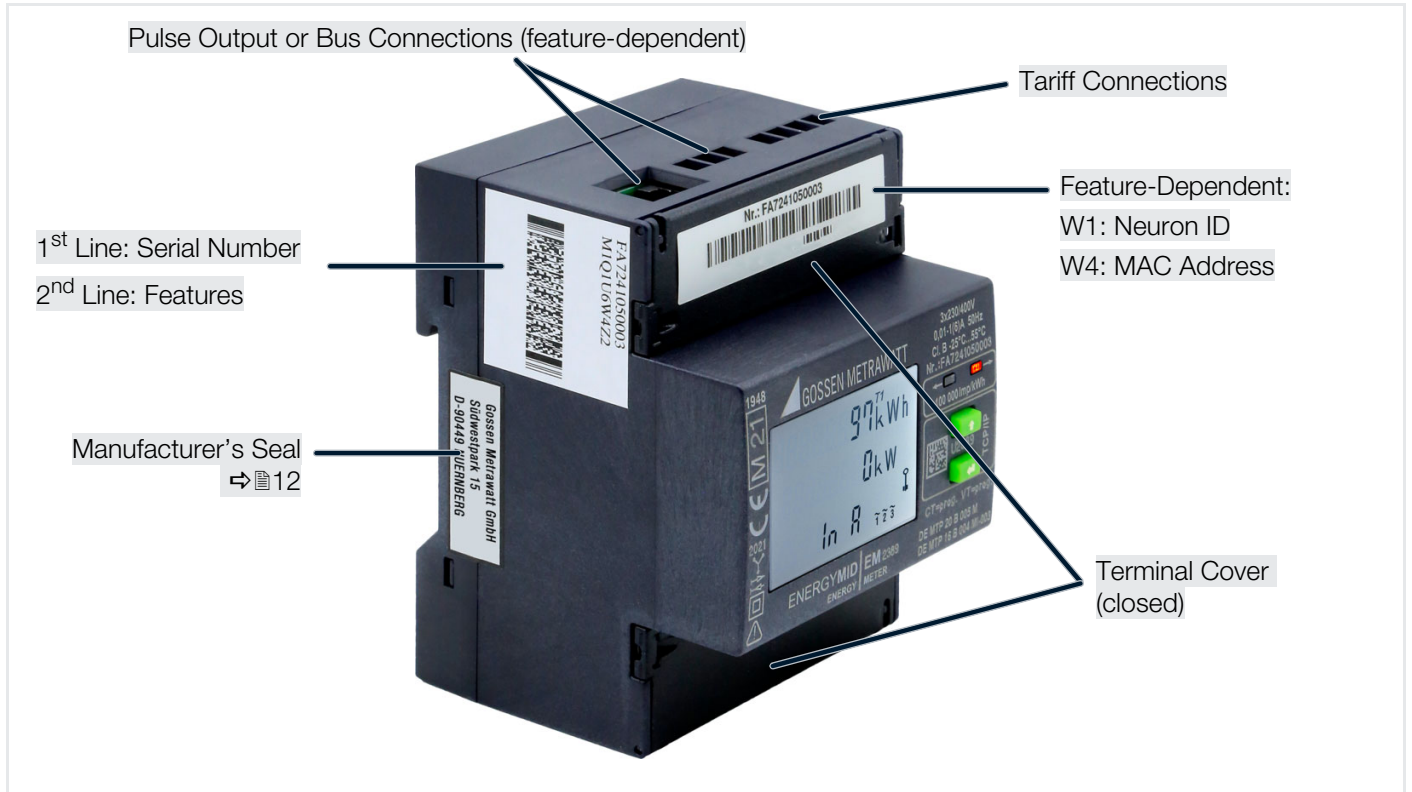
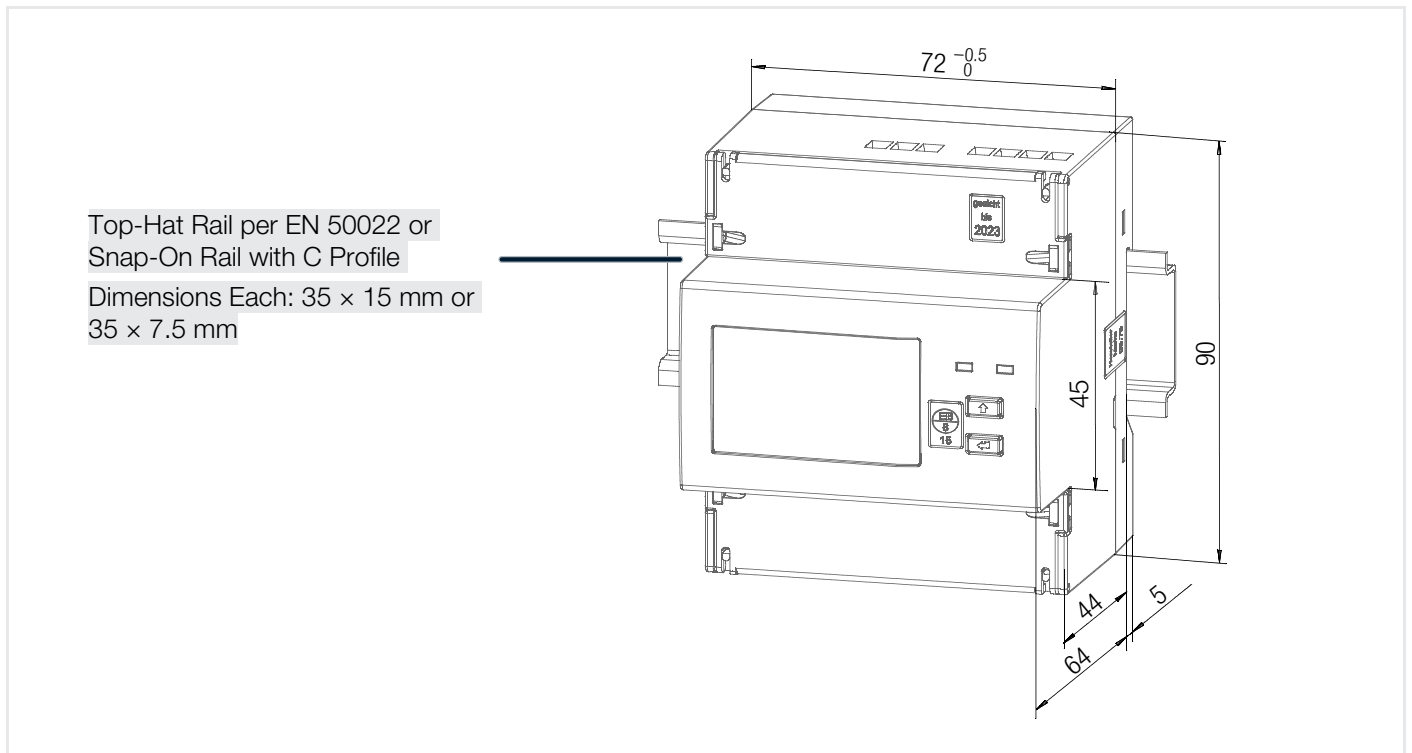

Figure 7: Instrument, Side View

### 5.4 DIMENSIONAL DRAWING



### 5.5 TAMPER-PROOF SEALING

The instrument is provided with various seals in order to protect it against unauthorized modifications.

One manufacturer's seal on the side:

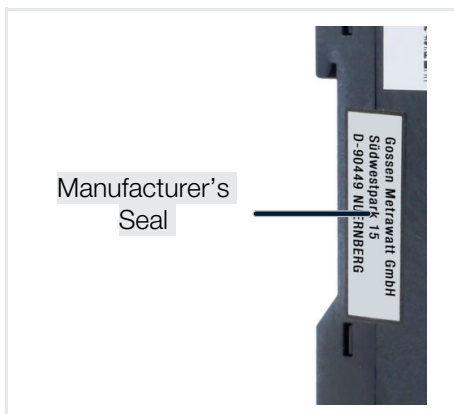

The manufacturer's seal serves as the instrument's calibration and guarantee seal.

## ATTENTION

### Violation of Calibration Law

An instrument with a broken manufacturer's seal may not be used for billing purposes.

Never break or damage the manufacturer's seal.

Four tamper-proof seals for the terminal cover (can be mounted to the left and right of each terminal cover):

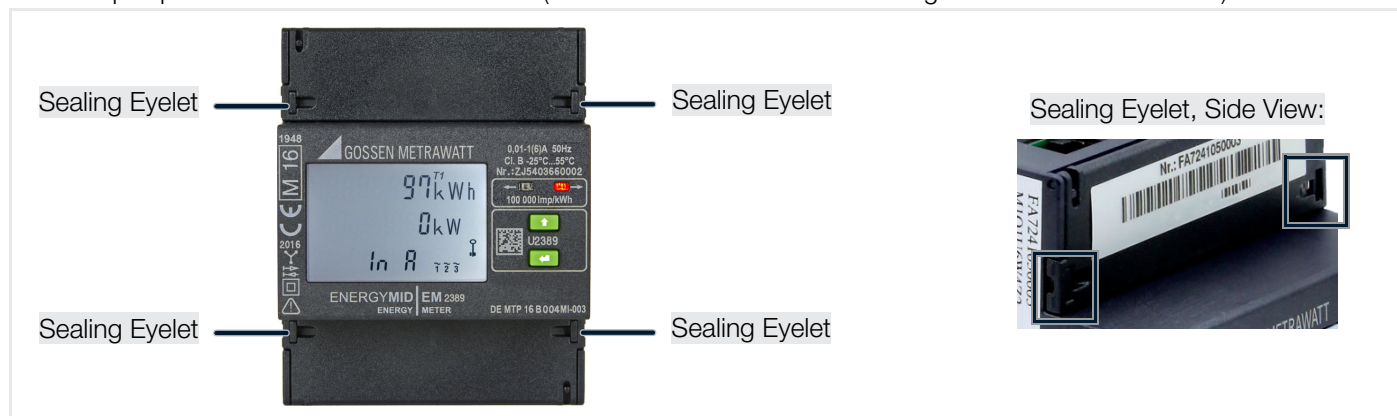

### 5.6 CONNECTIONS

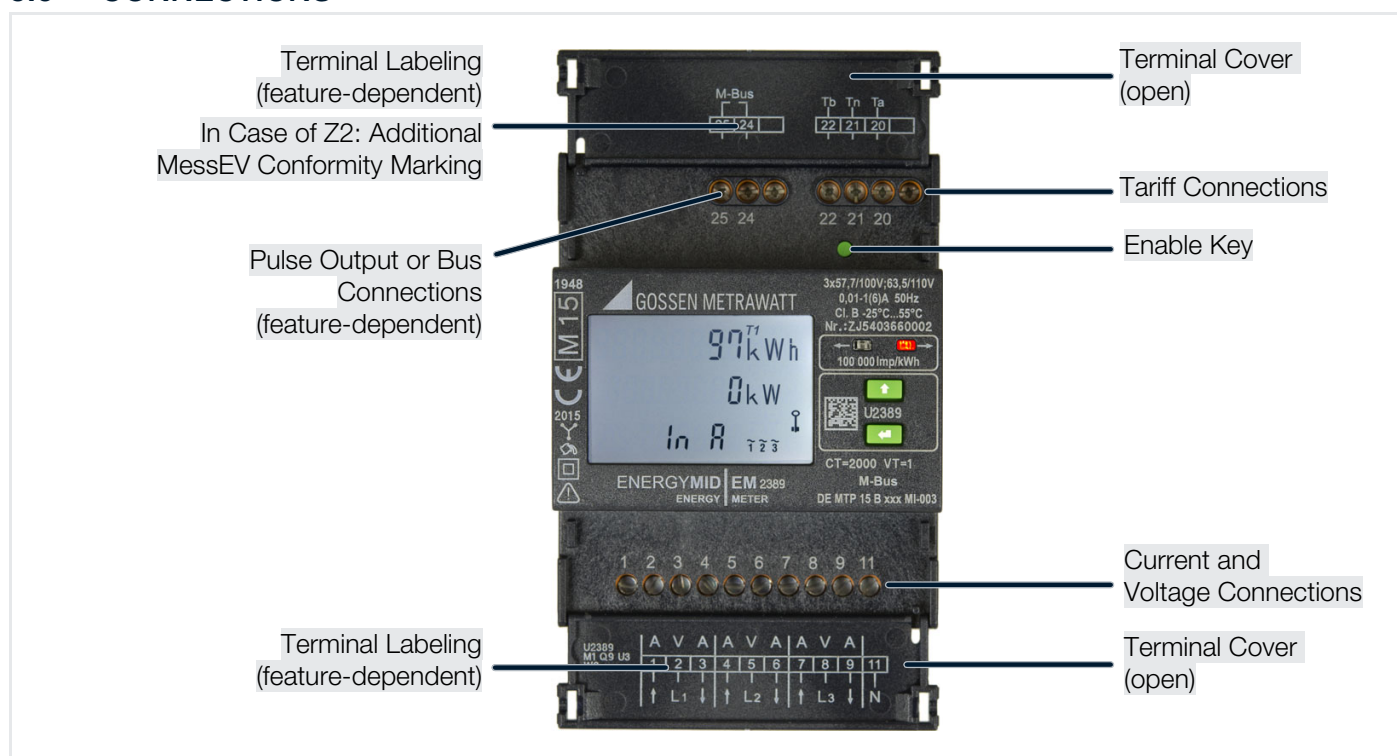
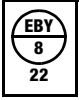

Figure 8: Instrument Connections (here: EM2389 with W2 M-Bus interface)

5.7 SYMBOLS ON THE INSTRUMENT AND THE INCLUDED ACCESSORIES



Marking with stamp of the federally approved test laboratory (for verification only / with feature P9)



CE and metrology mark with indication of year (M22) and registration number of the notified body for module D, country-specific calibration validity period



Metrological symbol for national approval in Germany (DE = Germany, M = Metrology) with indication of year (22) and registration number of the notified body

DE MTP XX B XXX

Prototype Test Certificate:

DE MTP XX B XXX MI-XXX

DE MTP 17 B 002 MI-003 = EM2281, EM2289

DE MTP 16 B 004 MI-003 = EM2381, EM2387, EM2389

DE MTP 20 B 004 = EM2281, EM2289 each with Z2

DE MTP 20 B 005 = EM2381, EM2387, EM2389 each with Z2



Meter type: bidirectional meter

➡ Energy received at the measuring point (i.e. import)

⬅ Energy supplied at the measuring point (i.e. export)



Anti-reversing



Mains type:

3-wire energy meter



Mains type:

2-wire energy meter



Double insulation (protection category II)



Warning concerning a point of danger (attention, observe documentation!)



European conformity marking



The tester may not be disposed of with household trash "Disposal and Environmental Protection" ⇒ 61.

## 5.8 RELEVANT STANDARDS, REGULATIONS AND DIRECTIVES

The instrument has been manufactured and tested in accordance with the following safety regulations.

### ATTENTION

**The design of the device does not release the user from the obligation to comply with legal regulations.**

Violation of legal regulations.

Always comply with all relevant legal regulations, for example the German weights and measures act (MessEG) and the German measuring and verification act (MessEV).

### Note

The currently valid version of the respective standard always applies unless a revision level is specified.

Directive 2014/32/EU of the European Parliament and of the Council of 26 February 2014 on the harmonisation of the laws of the Member States relating to the making available on the market of measuring instruments (revision) text with EEA relevance

DIN 43856	Electricity meters, tariff time switches and ripple control receivers; connection diagrams, terminal marking, circuit diagrams
DIN 43880	Built-in equipment for electrical installations; overall dimensions and related mounting dimensions
DIN 46200	Current carrying connection bolts up to 1600 A; design and assignment of current intensities
EN 50470-1:2006	Electricity metering equipment (a.c.) – Part 1: General requirements, tests and test conditions – Metering equipment (class indexes A, B and C)
EN 50470-3:2006	Electricity metering equipment (a.c.) – Part 3: Particular requirements – Static meters for active energy (class indexes A, B and C)
EN 55022	Information technology equipment – Radio disturbance characteristics – Limits and methods of measurement
EN 60529	Test instruments and test procedures – Degrees of protection provided by enclosures (IP code)
EN 61326-1	Electrical equipment for measurement, control and laboratory use – EMC requirements – Part 1: General requirements
EN 62052-1	Electricity metering equipment – General requirements, tests and test conditions – Part 11: Metering equipment
EN 62053-23	Electricity metering equipment (a.c.) - Particular requirements – Part 23: Static meters for reactive energy (classes 2 and 3)
EN 62053-31	Electricity metering equipment (a.c.) – Particular requirements – Pulse output devices for electro-mechanical and electronic meters (two wires only)
EN 62056-61	Electricity metering – Data exchange for meter reading, tariff and load control – Part 61: Object identification system (OBIS)
PTB-A 50.7	Requirements for electronic and software-controlled measuring instruments and ancillary equipment for electricity, gas, water and heat
PTB-A 50.7-1	Software requirements for measuring instruments and ancillary equipment according to PTB-A 50.7 equipment class 1: Simple instrument

## 5.9 TECHNICAL DATA

Some of the technical data are model and feature-dependent: You selected the device type and (optional) features when you placed your order. All options are listed with corresponding identification in the following table. The features included with your instrument can be found on the label on its side (⇒ 10) or in your order documents. A breakdown of the features can be found in the appendix ⇒ 63.

Tab. 2: Technical Data

<b>Connection</b>	EM2281, EM2289: Direct EM2381, EM2387, EM2389: Via transformer	
<b>Measurement type</b>	4-quadrant measurement	
<b>Multifunctional version</b>	Optional: U, I, P, Q, S, PF, f, THD, $I_N$ (M1) / reactive energy (M2) / U, I, P, Q, S, PF, f, THD, $I_N$ , THD, $I_N$ , reactive energy (M3) <sup>a</sup>	
<b>Meter reading profile</b>	Optional: meter reading profile (Z1) / certified meter reading profile PTB-A 50.7 (Z2)	
<b>Approval</b>	MID (conformity assessment procedure modules B and D) Optional: additional calibration certificate (P9)	
<b>Accuracy class</b>	B for industrial and commercial use, as well as for household use with highly demanding requirements	
<b>Mains type</b>	EM2281, EM2381: 2-wire system EM2289, EM2389: 4-wire system EM2387: 3-wire system	
<b>Current and voltage ranges</b>	Input voltage (reference voltage $U_n$ AC):	EM2281: 230 V L–N (U5) EM2289: 400 V L–L (U6) EM2381: 230 V L–N (U5) EM2387: 100 ... 110 V L–L (U3) / 400 V L–L (U6) / 500 V L–L (U7) EM2389: 100 ... 110 V L–L (U3) / 400 V L–L (U6)
	Nominal current (current limit value):	EM2281, EM2289: 5 (80) A EM2381, EM2387, EM2389: 1(6) A (including 5(6) A)
<b>Power consumption</b>	Total:	Single-phase: < 2 W (at nominal voltage) 3-phase: < 2 W (at nominal voltage) (where line frequency = 45 ... 65 Hz)
	Internal power supply:	From measuring voltage U: 80 to 115% $U_r$ 3.3 V / 100 mA With W4: 3.3 V / 200 mA (plus 100 mA for Ethernet)
	Voltage path, total (including supply):	< 2 VA
	Per current path:	At $I_{max}$ : < 1 VA for direct meter / < 0.2 VA for transformer meter At $I_{ref}$ : < 0.02 VA for direct meter / < 0.005 VA for transformer meter
<b>Ambient conditions</b>	Starting current:	Direct meter: approx. 17 mA at 0.1 - 5(80) A Transformer meter: approx. 1.5 mA at 0.01 - 1(6) A
	Operating temperature:	-25 ... +55 °C
	Storage temperature:	-25 ... +70 °C
	Relative atmospheric humidity:	Max. 95%, no condensation allowed Max. 75% annual average and non-condensing
<b>Place of use</b>	Elevation: Max. 2000 m	
	Indoors	

a. Not approved in Switzerland

Continued on next page.

<b>Electrical safety</b>	Pollution degree:	2
	Protection category:	II
	Insulating group:	II
	Utilization category (electrical switchgear):	(only for meters with direct connection) UC-2 (per EN 60947)
	Nominal insulation voltage:	Inputs: 300 V <sub>AC</sub> Output: 50 V <sub>DC</sub> (bus/S0) with V0, V1, V2, V7, V8, V9 230 V <sub>AC</sub> (pulse) with V3, V4
	Insulation test voltage:	Input ↔ output/housing: 4 kV <sub>AC</sub> Output ↔ housing: 500 V (bus/S0) with V0, V1, V2, V7, V8, V9 4 kV (pulse) with V3, V4
	Overload capacity:	All meters: continuous 1.15 U <sub>r</sub> and I <sub>max</sub> Direct connection: 5 × 3 s, U <sub>r</sub> and 100 A (5 min. interval) Direct connection: 1 × 1 s, U <sub>r</sub> and 250 A, 10 ms 2400 A Current transformer connection: 0.5 s and 20 × I <sub>max</sub>
	Overvoltage category:	III (per EN 62052-31) for feature U3: 63.5 (110) VAC feature U5 / U6: 230 (400) VAC
	Rated impulse voltage:	4 kV with basic insulation and 6 kV with reinforced insulation
<b>Electromagnetic compatibility (EMC)</b>	Interference emission:	EN 55022, class B
	Interference immunity:	EN 61326-1
	Electromagnetic classification	E2
<b>Mechanical design</b>	Mechanical classification:	M1
	Protection:	Front (panel-mount instrument): IP 51 (protection against ingress of solid foreign objects: protected against harmful amounts of dust, protection against ingress of water: protection against dripping water) Terminals: IP 20 (protection against ingress of solid foreign objects: ≥ 12.5 mm dia., protection against ingress of water: not protected) (per EN 60529 / IEC 60529)
	Housing (W × H × D):	4 standard width units, approx. 72 × ≤ 90 × ≤ 70 mm
	Housing material:	Lexan polycarbonate per UL94 V0
	Weight:	< 0.3 kg
	Mounting:	Top-hat rail per EN 50022 or snap-on rail with c profile, dimensions each: 35 × 15 mm or 35 × 7.5 mm
	Screw terminals:	Slotted screws, 16 mm <sup>2</sup> cross-section
	Display:	LCD, approx. 28 × 42 mm, 7-segment characters (0 ... 99,999,999 digits) 1 main display: max. 8-place, height: 5.6 mm, 2 auxiliary displays: 8-place, height: 5 mm Refresh: approx. 6 times per second
	Protection against tampering:	Tamper-proof cover, configuration disabling

Continued on next page.



<b>Interfaces</b>	Pulse output:	<p>The energy meters are equipped with two pulse outputs or one bus output as a standard feature.</p> <p>Model and feature-dependent, as well as optional:                  S0 standard, calibrated, 1000 pls/kWh (V1) /                  S0 programmable, 1 ... 1000 pls/kWh sec. (V2 with EM2281, EM2289) /                  S0 programmable, 1 ... 50,000 pls/kWh sec. (V2 with EM2381, EM2387, EM2389) /                  Switching output up to 230 V, calibrated, 1000 pls/kWh (V3)/                  Switching output up to 230 V, programmable, 1 ... 1000 pls/kWh (V4 with EM2281, EM2289) /                  Switching output up to 230 V, programmable, 1 ... 50,000 pls/kWh (V4 with EM2381, EM2387, EM2389) /                  S0 130 ms, calibrated, 100 pls/kWh (V7 with EM2281, EM2289) /                  S0 130 ms, calibrated, 100 pls/kWh, in combination with Q9 depending on CT × VT (V7 with EM2381, EM2387, EM2389) /                  S0 130 ms, calibrated, 1000 pls/kWh (V8) /                  Customer-specific S0, calibrated (V9)</p> <p>See "Pulse Outputs" ⇨ 18 for further information.</p>
	Bus connection:	<p>Optional:                  LON (W1) / M-Bus (W2) / Modbus RTU (W7) /                  TCP/IP (BACnet, Modbus TCP, HTTP) (W4)</p> <p>See "Bus Interfaces" ⇨ 19 for further information.</p>
	Tariff interface:	<p>4 tariffs (hardware controlled) and 4 additional tariffs via bus as option <sup>a</sup></p> <p>Power utility pulse:</p>
<b>Transformer ratio</b>	<p>EM2381, EM2387 and EM2389 only:                  default: CT = VT = 1, main display for secondary, calibrated (Q0)                  Feature-dependent alternative: CT and VT programmable, auxiliary display for secondary, calibrated (Q1) / fixed CT and VT, main display for primary, calibrated (Q9)</p>	

a. The 4 additional tariffs via bus are not included in the scope of MID approval.

## 5.10 CHARACTERISTIC VALUES

### 5.10.1 MEASURING RANGES

Voltage	Reference voltage $U_n$ AC:	U3: 100 ... 110 V L-L U5: 230 V L-N U6: 400 V L-L U7: 500 V L-L
	Allowable deviation:	-20% ... +15%
Current	$I_{ref}$	Direct connection: 5 A Transformer connection: 1 A
	Starting current	Direct connection: 20 mA Transformer connection: 2 mA
	$I_{min}$	Direct connection: 0.1 A Transformer connection: 0.01 A
	$I_{max}$	Direct connection: 80 A Transformer connection: 6 A
Frequency range	Nominal frequency:	50 Hz
	Cutoff frequency:	45 Hz ... 65 Hz
Accuracy	Active energy:	Class B per EN 50470-3
	Reactive energy:	Class 2 per EN 62053-23
Sampling rate	Continuous, 32 per period	

### 5.10.2 INPUTS, OUTPUTS AND INTERFACES

The energy meters are equipped with two pulse outputs or one bus output depending on model and variant.

#### Note

Circuit diagrams, terminal assignments etc. can be found under "Initial Startup" → 21.

### 5.10.3 TARIFF INPUTS

All instruments are equipped with 4 hardware-controlled tariff inputs. The tariffs are controlled via these tariff inputs by applying certain voltage levels:

- Level 0 = < 12 V<sub>AC</sub>
- Level 1 = 45 ... 265 V<sub>AC</sub>

Depending on the combination of levels 0 and 1, the values measured at the instrument are recorded in the corresponding tariff. Recording is thus possible in a daytime and a nighttime tariff, for example.

Instruments with bus (features W1, W2, W4, W7) have 4 additional software-controlled tariffs (not included in the scope of MID approval). Further information can be found in the respective interface description. See "Bus Connections (features W1, W2, W4, W7)" → 49.

The active tariff appears at the display → 30.

### 5.10.4 PULSE OUTPUTS

Pulses are transmitted via the pulse outputs (pulses per kWh). One of 4 pulse sources can be selected for each output: active energy import, active energy export, reactive energy import or reactive energy export. Pulse frequency and duration can also be adjusted on some models and variants.

Direct connection: Pulse frequency is proportional to measured energy.

Transformer connection: Primary values are transmitted. Pulse frequency is proportional to primary energy and the selected CT value (current transformer ratio) is taken into consideration.

The pulse outputs are electrically isolated from the measuring circuit by means of an optocoupler.

**Electrical Values**

Pulse frequency:	With direct connection: 1000 pls/kWh (adjustable with V2/V4) With transformer connection: 1000 pls/kWh (adjustable with V2/V4)
Pulse duration:	30 ms (adjustable up to 3 s with V2, V4)
Interpulse period:	> 30 ms
U <sub>ext</sub> :	Max. 40 V (375 V with V3, V4)
Switching current:	Max. 27 mA (100 mA with V3, V4)

**Feature Q1**

Only the auxiliary display is calibrated. As a result, only the secondary values (menu selection) can be used for billing purposes.

**Feature Q9**

Pulse rates are specified in relation to the primary side.

CT x VT	In combination with V1 / V3, calibrated	In combination with V7	In combination with V2 / V4, not calibrated
	Fixed	Fixed	Programmable
2 ... 10	1000 pls/kWh	100	1 ... 1000 pls/kWh
11 ... 100	100 pls/kWh	10	0.1 ... 100 pls/kWh
101 ... 1000	10 pls/kWh	1	0.01 ... 10 pls/kWh
1001 ... 10,000	1000 pulses per MWh	100	1 ... 1000 pls/MWh
10,001 ... 100,000	100 pulses per MWh	10	0.1 ... 100 pls/MWh
100,001 ... 1,000,000	10 pulses per MWh	1	

**5.10.5 BUS INTERFACES**

Interface	Feature	Note
LON-Bus	W1	
M-Bus	W2	The standard M-Bus secondary address consists of the last 8 digits of the serial number.
TCP/IP (BACnet, Modbus TCP, HTTP)	W4	
Modbus RTU	W7	

Interface descriptions can be found at

<https://www.gmc-instruments.de/en/services/download-center/>



5.10.6 BLOCK DIAGRAM FOR SAFETY SPECIFICATION

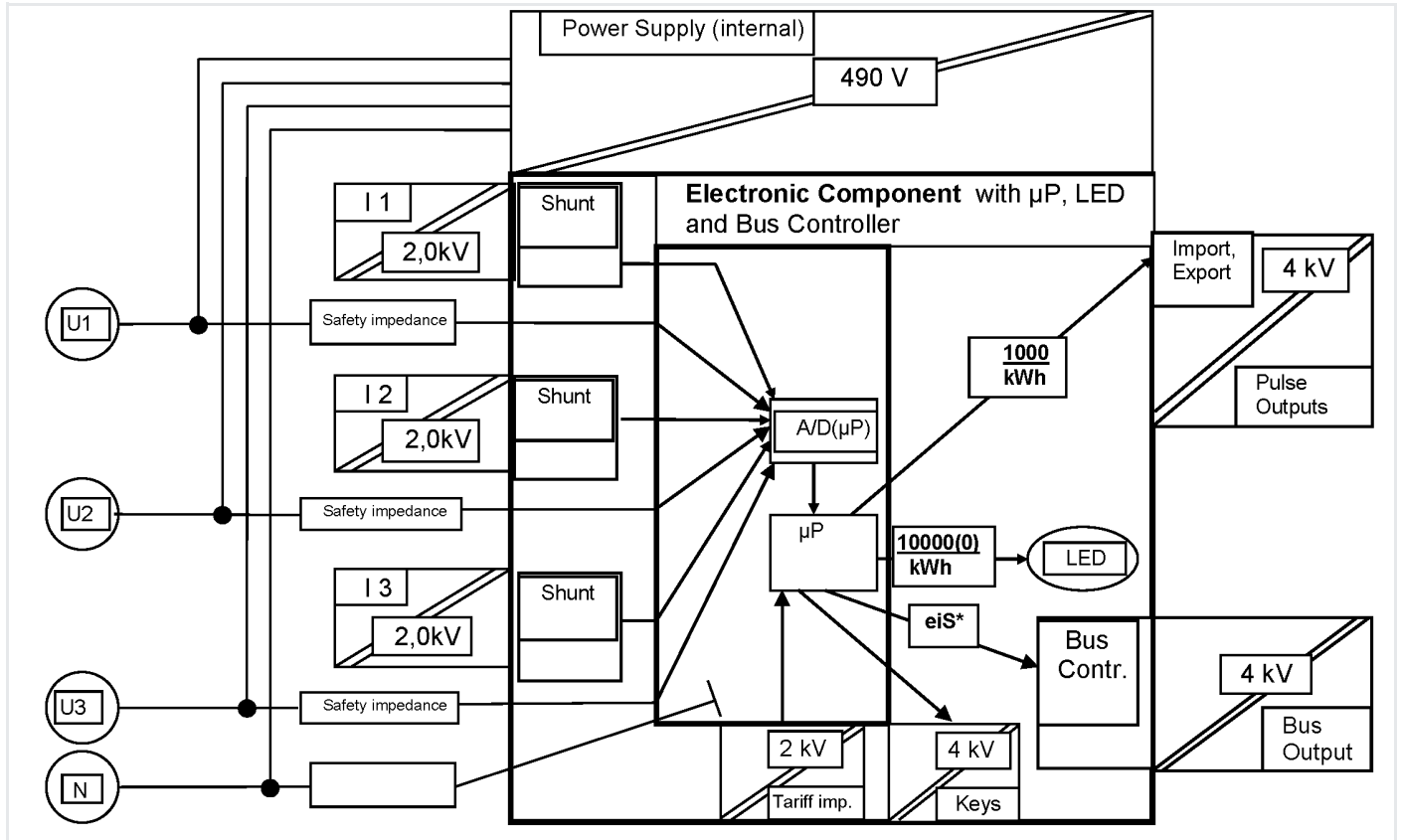

\* Uniform internal interface

5.11 OBIS FIGURES

Tab. 3: OBIS Figures (object identification system) per EN 62056-61

Measured Quantity		OBIS Figure	Measured Quantity		OBIS Figure
Active energy – import	Total	1.8.0	Active energy – export	Total:	2.8.0
	Tariff 1:	1.8.1		Tariff 1:	2.8.1
	Tariff 2:	1.8.2		Tariff 2:	2.8.2
	Tariff 3:	1.8.3		Tariff 3:	2.8.3
	Tariff 4:	1.8.4		Tariff 4:	2.8.4
	Tariff 5:	1.8.5		Tariff 5:	2.8.5
	Tariff 6:	1.8.6		Tariff 6:	2.8.6
	Tariff 7:	1.8.7		Tariff 7:	2.8.7
	Tariff 8:	1.8.8		Tariff 8:	2.8.8
Reactive energy (M2/M3) – import	Total:	3.8.0	Reactive energy (M2/M3) – export	Total:	4.8.0
	Tariff 1:	3.8.1		Tariff 1:	4.8.1
	Tariff 2:	3.8.2		Tariff 2:	4.8.2
	Tariff 3:	3.8.3		Tariff 3:	4.8.3
	Tariff 4:	3.8.4		Tariff 4:	4.8.4
	Tariff 5:	3.8.5		Tariff 5:	4.8.5
	Tariff 6:	3.8.6		Tariff 6:	4.8.6
	Tariff 7:	3.8.7		Tariff 7:	4.8.7
	Tariff 8:	3.8.8		Tariff 8:	4.8.8

## 6 INITIAL STARTUP

Initial instrument startup includes installation at the place of use as well as connection to your equipment:

- ⇨ "Unpacking" 21
- ⇨ "Installation" 21
- ⇨ "Connection to Your Equipment (interfaces)" 28

### Note

This document only describes technical startup of the instrument. Inform yourself about further measures that may have to be taken into account during initial startup, for example, documentation (installation verifications, meter numbers, meter readings etc.) or other administrative requirements (photos, inspections etc.).

### 6.1 UNPACKING

Check the entire scope of delivery for transport damage, in particular the instrument.

### Note

We recommend keeping the packaging and using it when sending the instrument in for recalibration, as well as for storage if the instrument is not going to be used for a lengthy period of time. See "Transport and Storage" ⇨ 59.

### 6.2 INSTALLATION

Installation is broken down into individual steps that have to be carried out in a specific order. They're explained in the following sections:

1. Mounting of the instrument onto a top-hat rail or snap-on rail with C-profile, e.g. in the control cabinet ⇨ "Mounting" 22
2. Connecting the instrument to supply power and for data communication ⇨ "Connection" 23
3. As soon as the instrument is supplied with power, any connection errors are detected automatically. Instructions on how to interpret and rectify such errors are provided in ⇨ "Display of Connection Errors and Troubleshooting" 28.

*At this point, the device must first be configured. Corresponding information can be found under ⇨ "Configuration and Operation" 34.*

4. Attaching seals to the instrument ⇨ "Sealing" 28



## DANGER

### Danger of Injury

Installation involves risks which may not be recognized as such by inadequately trained persons (e.g. electric shock and arcing).

- Installation may only be performed by a qualified electrician.
- Observe and comply with all safety regulations which are applicable for your work environment.
- Wear suitable and appropriate personal protective equipment (PPE) whenever working with the instrument.

## 6.2.1 MOUNTING

The instrument may only be mounted inside an external housing, e.g. switch cabinet or meter cabinet. The housing must provide at least IP 51 protection and must be located indoors. Only in this case is protection against dust and water ingress guaranteed in accordance with the EN 50470-1.

The instrument is mounted on a top-hat rail in accordance with EN 50022 or on a snap-on rail with C-profile. The rail must measure 35 × 15 mm or 35 × 7.5 mm.

If no corresponding rail is available, a door mounting kit (U270B) is required.

Dimensions with relevance for mounting can be found in the dimensional drawing ↗ 11.



### DANGER

#### Electric shock due to live components!

#### Life endangering due to electric arcs!

Touching voltage conducting components is life endangering!

During installation, the installation environment must be voltage-free.

When disconnecting, observe the five safety rules in accordance with DIN VDE 0105-100, Operation of electrical installations – Part 100: General requirements:

1. Shut down entirely.
2. Secure against restart.
3. Assure absence of voltage at all poles.
4. Ground and short circuit.
5. Cover neighboring live components, or make them inaccessible.

### ATTENTION

#### Incorrect Installation Site

Faulty installation can cause damage to the product due to environmental influences – either immediately or in the long term.

Your system can also be damaged by faulty installation.

- Install the instrument only in environments that meet the specified conditions (temperature etc.) ↗ "Technical Data" 15.
- Do not install the instrument in locations where it may be exposed to direct sunlight.
- Do not install the instrument in potentially explosive atmospheres.

### ATTENTION

#### Damaged Instrument

A faulty instrument can damage your system.

Moreover, it cannot be used for billing purposes.

- Only install the device if it's in good working order. Inspect the instrument before installation. Pay particular attention to damage.
- Do not install the instrument after long periods of storage under unfavorable conditions (e.g. humidity, dust or extreme temperature).
- Do not install the instrument after extraordinary stressing due to transport.

### Rail Mounting

Required tool: small slotted screwdriver

- ✓ The installation location is an enclosure with IP 51 protection located indoors.
  - ✓ A top-hat rail in accordance with EN 50022 or a snap-on rail with C-profile (dimensions: 35 × 15 mm or 35 × 7.5 mm) is available at the installation site.
  - ✓ All cables have been removed from the instrument.
1. Position the instrument at the desired location on the top-hat rail or snap-on rail with C-profile. Hook the two protruding hooks on the back of the housing into the top of the rail to this end.
  2. Use the slotted screwdriver to pull down the snap connector on the bottom of the unit at the back, and hold it there. Push the slotted screwdriver into the slot and pull down to this end.
  3. Push the instrument down onto the rail with your other hand and allow the snap connector to slide up. The locking mechanism latches into place.
- ↳ The instrument is firmly mounted on the top-hat rail or snap-on rail with C-profile.  
You can now proceed with connection ⇨ "Connection" 23.

### Door Mounting Kit (U270B)

Required tool: small slotted screwdriver

- ✓ A door mounting kit (U270B) is available.
- ✓ All cables have been removed from the instrument.

Observe and follow the instructions in the product documentation for the door mounting kit (U270B). To mount the device on the respective rail, follow the instructions provided above under ⇨ "Rail Mounting" 23.

## 6.2.2 CONNECTION

First of all, familiarize yourself with the connections and all associated information: all necessary information can be found in the tables and figures included below. Instructions for the procedure are provided at the end of the section.

### Wire Gauge and Torque

Connection	Direct Meter (EM2281, EM2289)	Transformer Meter (EM2381, EM2387, EM2389)
Current input	Fine wire: 6 to 16 mm <sup>2</sup> Solid wire: 6 to 25 mm <sup>2</sup> With wire end ferrule: 6 to 16 mm <sup>2</sup>  Torque: 3 Nm	Fine wire: 0.5 to 4 mm <sup>2</sup> Solid wire: 0.5 to 6 mm <sup>2</sup> With wire end ferrule: 0.5 to 2.5 mm <sup>2</sup>  Torque: 0.5 Nm
Voltage input	–	Fine wire: 0.5 to 4 mm <sup>2</sup> Solid wire: 0.5 to 6 mm <sup>2</sup> With wire end ferrule: 0.5 to 2.5 mm <sup>2</sup>  Torque: 0.5 Nm
S0 pulse output, bus output, tariff input (power utility pulse)	Fine wire: Solid wire: With wire end ferrules:  Torque:	0.2 to 2.5 mm <sup>2</sup> 0.2 to 2.5 mm <sup>2</sup> 0.25 to 1.5 mm <sup>2</sup>  0.4 Nm
LON (W1) <sup>a</sup>	Twisted pair copper cable, recommended: JY (ST) Y 2 × 2 × 0.8 mm with twisted wire pairs (where 0.8 mm = wire diameter, wire cross-section = 0.5 mm <sup>2</sup> ), maximum cable length of 900 m with bus topology (bus terminator at both ends), 500 m with free topology (bus terminator at one end) or 320 m from device to device	
M-Bus (W2) <sup>a</sup>	2-wire twisted-pair	
TCP/IP (W4) <sup>a</sup>	RJ-45 (8P8C)	
Modbus (W7) <sup>a</sup>	2-wire twisted-pair, shielded if possible, maximum length of 1000 m (depending on cable thickness and transmission speed), cross-section of at least 0.22 mm <sup>2</sup> , wave impedance approx. 100 to 150 Ω, terminating resistors at both ends (the following applies: resistance value = line impedance)	

a. For detailed information, refer to the interface description for your instrument which can be found at:

<https://www.gmc-instruments.de/en/services/download-center/>



### Terminal Assignments

All connection elements are laid out as self-locking screw terminals (slotted screws, 16 mm<sup>2</sup> cross-section), except for the TCP/IP interface which is equipped with an RJ-45 connector.

EM2281, EM2289 – Direct Connection

Top terminals:

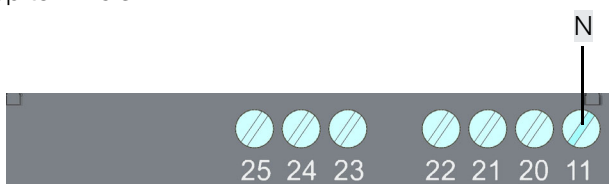

Bottom terminals:

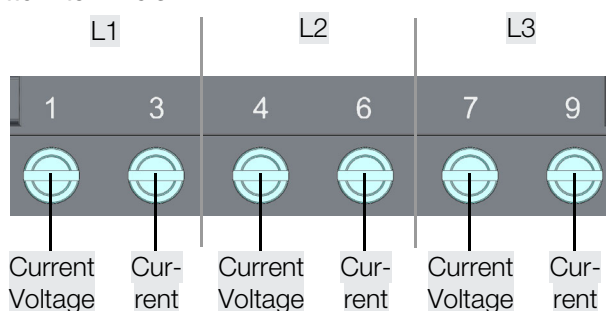

EM2381, EM2387, EM2389– Transformer Connection

Top terminals:

- W1: LON
- W2: M-Bus
- W4: TCP/IP
- W7: Modbus RTU
- V1 ... 9: S0 pulse output

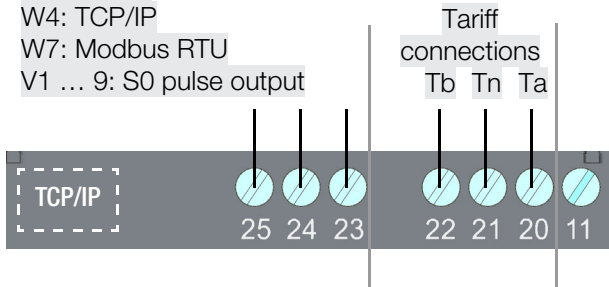

Bottom terminals:

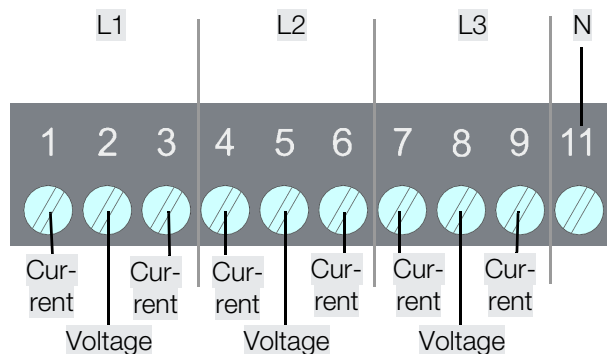

### Wiring Diagrams – Current and Voltage

EM2281 – Direct Connection

2-Wire AC System, Any Load

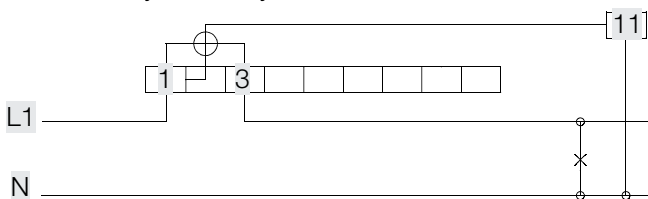

EM2289 – Direct Connection

4-Wire AC System, Any Load

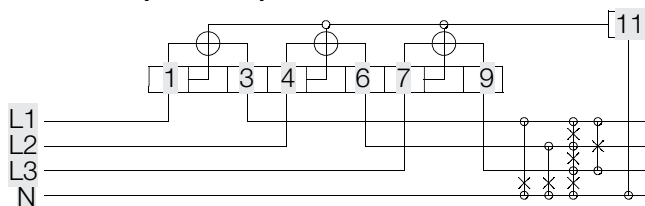



EM2381 – Transformer Connection  
2-Wire AC System, Any Load

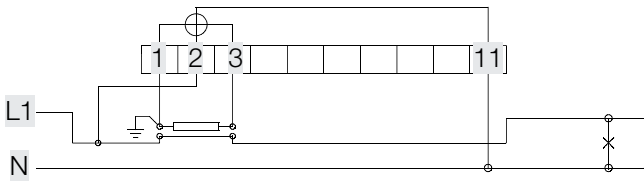

EM2387 – Transformer Connection  
3-Wire AC System, Any Load

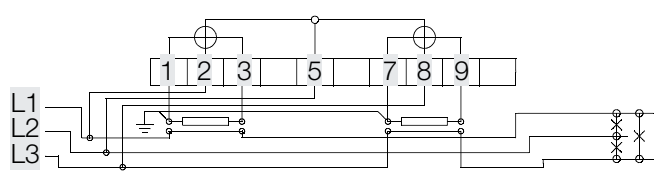

EM2389 – Transformer Connection  
4-Wire AC System, Any Load

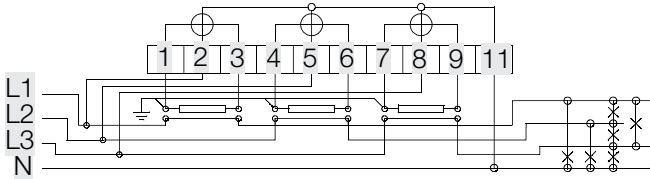

Wiring Diagrams – Pulse Output

Feature V1 / V2 / V7 / V8 / V9:

**I = max. 27 mA**

Energy type\* (can be selected with feature V2, V4)

Standard pulse duration: 30 ms + 5%, interpulse period: > 30 ms  
V7/V8 pulse duration: 130 ms + 5%, interpulse period: > 130 ms

Default setting: active energy  
Terminal 23 (S01): import, terminal 25 (S02): export

Feature V3 / V4:

**I = max. 100 mA**

Energy type\* (can be selected with feature V2, V4)

Standard pulse duration: 30 ms + 5%, interpulse period: > 30 ms  
V7/V8 pulse duration: 130 ms + 5%, interpulse period: > 130 ms

Default setting: active energy  
Terminal 23 (S01): import and terminal 25 (S02): export

## Tariff Connections

For the hardware-controlled tariff connections, tariff inputs Ta and Tb are each connected with reference to Tn.

Tariff Inputs	Tb	Ta	
Tariff 1	0	0	Level 0: < 12 V <sub>AC</sub>
Tariff 2	0	1	Level 1: 45 ... 265 V <sub>AC</sub>
Tariff 3	1	0	
Tariff 4	1	1	

### Procedure

Required tool: small slotted screwdriver

Required materials: Connecting cables or leads

- ✓ The instrument is mounted on the top-hat rail or snap-on rail ⇒ "Connection" ¶23.
- ✓ You have examined the terminal assignments and connection diagrams and are familiar with the wiring required for your instrument.

First of all, connect the instrument to the S0 pulse outputs or bus connections. Then supply the instrument with electrical power. This is described below. Skip the steps which do not apply to your instrument.



## DANGER

### Electric shock due to live components!

#### Life endangering due to electric arcs!

Touching voltage conducting components is life endangering!

- During installation, all lines connected to the meter must be voltage-free. When disconnecting, observe the five safety rules in accordance with DIN VDE 0105-100, Operation of electrical installations – Part 100: General requirements:
  1. Shut down entirely.
  2. Secure against restart.
  3. Assure absence of voltage at all poles.
  4. Ground and short circuit.
  5. Cover neighboring live components, or make them inaccessible.
- Observe all regulations and standards which apply to your installation and operating environment.

## ATTENTION

### Incorrect Installation

Incorrect installation may result in property damage to the product and/or the respective system.

Risk of operational malfunctions.

- Observe the specified technical data and characteristic values (nominal voltage, maximum pulse output voltage etc.). See ⇒ "Technical Data" ¶15 and ⇒ "Characteristic Values" ¶18.
- Comply with the respectively permissible torque value (see above). Excessive torque damages the terminals and/or connection cables or leads.
- Connection cables must be selected appropriately with regard to type, conductor cross-section, voltage, ambient conditions and maximum load.
- Connection cables must be voltage-free when wiring the instrument.
- Low-resistance contact must be ensured when connecting measuring current.

### Transformer Connection

- The secondary side of the current and voltage transformers must be grounded.

**Note**

The installation technician is responsible for:

- Coordination of the rated values and the characteristic values of the overcurrent protection devices on the supply side, including maximum current rating values.
- The rated utilization category of the metering equipment in case of directly connected meters.

1. Open both terminal covers by flipping them up or down respectively.
2. Connect the connection cables or leads to the S0 pulse output or bus output.
  - Loosen one screw terminal.
  - Insert the respective connection cable or lead into the corresponding terminal.
  - Retighten the screw terminal.
  - Repeat this procedure for all other necessary connection cables and/or leads.
  - With TCP/IP Interface: Plug the RJ-45 cable into the RJ-45 socket.
3. Connect the connection cables or leads to the tariff connections.
  - Loosen one screw terminal.
  - Insert the respective connection cables or leads into the corresponding terminals.
  - Retighten the screw terminals.
  - Repeat this procedure for all other necessary connection cables and/or leads.
4. Connect the connection cables or leads to the current and voltage terminals.
  - Loosen one screw terminal.
  - Insert the respective connection cables or leads into the corresponding terminals.
  - Retighten the screw terminals.
  - Repeat this procedure for all other necessary connection cables and/or leads.
5. Make sure that all connecting cables or leads are correctly connected: phase connections, neutral conductor, current flow direction etc. (model and feature-dependent).
6. Install conductor protection if necessary.
7. Close the two terminal covers in order to provide effective protection for the terminals in accordance with IP 20.

**Note**

Do not attach the seals until later.

You'll need access to the components under the terminal covers for configuration (⇒ 28) and, if necessary, for correcting installation errors (⇒ 28).

8. Supply the instrument with electrical power.  
The instrument is switched on automatically.
9. Check the installation and eliminate any possible errors:
  - One of the two LEDs (⇒ 10) must blink.
  - Any possible connection error is displayed. Display and troubleshooting is explained in the next section ⇒ "Display of Connection Errors and Troubleshooting" 28.

*Measured power can also be checked. The prevailing power factor  $\cos\phi$  must be known to this end: measure current and calculate power taking applied voltage into consideration. Compare the theoretically determined value with power indicated at the display (⇒ 30).*

- ↳ The instrument is ready for operation.  
You can reverse the disconnection measures.  
Familiarize yourself with ⇒ "Display and Operation" 30 and configure the instrument ⇒ 34. The instrument must be sealed after configuration in order to protect it from unauthorized changes or tampering ⇒ 28.

### 6.2.3 DISPLAY OF CONNECTION ERRORS AND TROUBLESHOOTING

In the event of a connection error, this is automatically detected and indicated by the display. Depending on the respective meaning, check your connections and correct any wiring errors. Observe and follow the instructions and safety information included in ⇨ "Connection" 23.

Display Performance	Meaning
Cyclical blinking of 1 and 2 and 3, display blinks red.	Incorrect phase sequence (rotating field direction)
1 and/or 2 and/or 3 are not displayed, display blinks red.	Phase failure or $U < 75\%$
1 and/or 2 and/or 3 blinks, display blinks red.	Negative power Reversed current transformer polarity at the respective phase (current transformer is incorrectly connected or defective)

### 6.2.4 SEALING

In order to protect the device against inadvertent changes or tampering, the instrument's terminal covers must be closed and sealed.

#### Note

Do not seal the device until after it has been configured! See "Configuration and Operation" ⇨ 34.

Otherwise the seals will have to be removed and replaced.

Required tools: Sealing pliers

Required materials: Sealing wire (< 1.7 mm), seals (plastic, metal)

1. Close both terminal covers.
  2. Attach seals to all 4 sealing eyelets. See "Tamper-Proof Sealing" ⇨ 12.  
Observe the product documentation for the sealing tool and materials, as well as your own work instructions and procedures.
- ↳ The instrument is protected.

## 6.3 CONNECTION TO YOUR EQUIPMENT (INTERFACES)

Connection to your equipment is established via (feature-dependent) interfaces. A description of the respective interface can be found in the following subsections.

Observe and follow the associated product documentation for connection to other components. For example, instructions for interaction with other components from the product range of Gossen Metrawatt GmbH – e.g. SMARTCONTROL and SU1604 summators or EMC 5.x energy management software – can be found in the respective product documentation.

### 6.3.1 LON INSTALLATION (FEATURE W1)

The LON interface has been electrically connected during installation (⇨ 21). In order to commission the interface, the instrument can be integrated into a LON network either manually or via an installer. All information and files required to this end can be found on the download page for your instrument at:

<https://www.gmc-instruments.de/en/services/download-center/>



### 6.3.2 M-BUS INSTALLATION (FEATURE W2)

The M-Bus interface has been electrically connected during installation (⇒ 21). The EnergyMID software tool provides assistance when starting up the interface. All information and files required to this end can be found on the download page for your instrument at:

<https://www.gmc-instruments.de/en/services/download-center/>



### 6.3.3 TCP/IP – BACNET, MODBUS TCP, HTTP (FEATURE W4)

The RJ-45 interface has been connected during installation ⇒ 21.

The instrument is equipped with an integrated web server. Further information concerning initial startup can be found on the download page for your instrument at:

<https://www.gmc-instruments.de/en/services/download-center/>



### 6.3.4 MODBUS RTU (FEATURE W7)

The Modbus interface has been electrically connected during installation (⇒ 21). All information and files required for initial startup of the interface can be found on the download page for your instrument at:

<https://www.gmc-instruments.de/en/services/download-center/>



## 7 DISPLAY AND OPERATION

### 7.1 DISPLAY

Measured quantities (e.g. active energy) and information (e.g. active tariff) appear at the instrument's display. Depending on the type of multifunctional variant, the instrument is capable of acquiring reactive power and indicating up to 33 additional measured quantities directly at the display.

This makes it possible to view information at any time concerning voltage levels, loads placed on individual phases, reactive power component and the functioning of compensation systems.

#### Significance of Symbols

Lock symbols (keys) for parameter settings:

with features Q1 and V2, V4:

 CT, VT and S0 parameters can be changed depending on features.

 CT, VT and S0 parameters disabled.

All other feature combinations:

 CT, VT or S0 parameters (which are or can be calibrated) are preset at the factory and can be queried in the display mode, other values are adjustable.

 Parameters which are or can be calibrated are preset\*\* at the factory; other parameters are disabled with the enable key and can be adjusted after reenabling.

Main display:

active energym\* in kWh or MWh  
(M2/M3: reactive energy\* in kVArh or MVArh)

 = main display is not calibrated  
(feature Q1, programmable CT/VT) (⇨ 47)

Auxiliary display 1:

active power\* in kW or MW  
(M2/M3: reactive energy or power in kVAr(h) or MVAr(h)\*)

Auxiliary display 2:

(e.g. IN, OUT for import or export)  
Error: error code alternates with momentary display

Display of instantaneous power in 4 quadrants: positive or negative active power P, positive or negative reactive power Q.

Correct connection:

Continuous illumination of the phase symbols where  $P \geq 0$

Phase failure:

Symbol for affected phase is cleared from the display.

Incorrect phase sequence:

Phase symbols blink in following order: 3 - 2 - 1, background illumination blinks red.

Negative power: respective phase symbol blinks.

T1 ... T8: active tariff

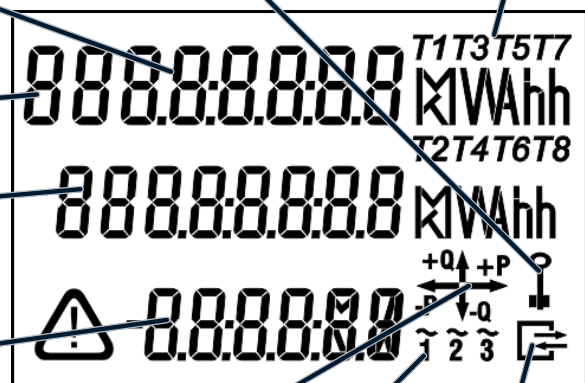

For bus connection:  
appears when the meter transmits a data packet.

\* Transformer meter EM238x: CT and VT are taken into consideration.  
Power: negative sign for export

\*\* Values which are preset at the factory are printed additionally on the rating plate.

Figure 3: Significance of Display Elements

### Background Illumination

The display is illuminated. Background illumination is activated whenever a key is pressed. It goes out if no keys are pressed for a duration of 2 minutes.

Colors indicate various display menus:

Table 4: Meanings of Background Illumination Colors

Color	Meaning
White	Retrieval menus for viewing values (⇒ "Configuration and Operation" 534)
Pink	Parameter display and setting menus (⇒ "Configuration and Operation" 534)
Red	Firmware version display (⇒ 51)
Blinking red:	Error (see below)

### Error Display

The display blinks red in the event of an error. An error code is also displayed, which consists of a triangle icon and text. Complete information concerning the individual codes and error elimination can be found in Kapitel "Fault Conditions and Troubleshooting" ⇒ 53.

### Main Display Resolution (first display line) – Energy Import

Internally, metering is executed with increased resolution. As a result, the last place in the overall register may be a few digits higher than the sum of the individual registers if multiple tariffs are used.

Table 5: Main Display Resolution

Pulse Rates	V1/V3, fixed	V7	V8	V9, fixed	V2/V4, programmable
	[pls/kWh]				
<b>Direct Meter</b>	<b>EM2281, EM2289</b>				
	1000	100	—	—	1 ... 1000 pls/kWh
<b>Transformer Meter</b>	<b>EM2381, EM 2387, EM2389</b>				
	<b>f (secondary)</b>				
				100 ...	
<b>CT x VT = 1 (Q0)</b>	1000	100	1000	50000	1... <u>1000</u> ...10,000 pls/kWh
<b>CTxVT=1(Q0)U6/7</b>	1000	100	1000	20000	1... <u>1000</u> ...10,000 pls/kWh
<b>CTxVT=1(Q0) U3</b>	1000	100	1000	50000	1... <u>1000</u> ...10,000 pls/kWh
<b>CT, VT, progr. (Q1)</b>	1000	100	1000	50000	1... <u>1000</u> ...50,000 pls/kWh
<b>CT, VT, progr. (Q1)U6/7</b>	1000	100	1000	20000	1... <u>1000</u> ...50,000 pls/kWh
<b>CT, VT, progr. (Q1)U3</b>	1000	100	1000	50000	1... <u>1000</u> ...50,000 pls/kWh
<b>CTxVT; CT, VT, fixed (Q9)</b>	<b>f (primary)</b>				<b>f (primary)</b>
2 ... 10	1000	100	—	—	1 ... <u>1000</u> pls/kWh
11 ... 100	100	10	—	—	0.1 ... <u>100</u> pls/kWh
101 ... 1000	10	1	—	—	0.01 ... <u>10</u> pls/kWh
1001 ... 10,000	1	100	—	—	1 ... <u>1000</u> pls/MWh
10,001 ... 100,000	0.1	10	—	—	0.1 ... <u>100</u> pls/MWh
100,001..1,000,000	0.01	1	—	—	0.01 ... <u>10</u> pls/MWh

Underlined values are default values.

**Standard Display and Calibration Display Resolution**

Table 6: Standard Display and Calibration Display

Meter / Feature		CT × VT min.	CT × VT max.	Standard display	Calibration display *	Unit
<b>Direct Meter</b> EM2281, EM2289		—	—	123456.78	23456.789	kWh
<b>Transformer Meter</b> EM2381, EM 2387, EM2389	<b>Q0</b>	1	1	12345.678	2345.6789	kWh
	<b>Q9</b>	2	4	12345.678	2345.6789	kWh
		5	40	123456.78	3456.7890	kWh
		41	400	1234567.8	34567.890	kWh
		401	4000	12345678	345678.90	kWh
		4001	40000	123456.78	3456.7890	MWh
		40001	400000	1234567.8	34567.890	MWh
		400001	1000000	12345678	345678.90	MWh
	<b>Q1 **</b>	1	4	u12345.67	**	kWh
		5	40	u123456.7	**	kWh
		41	400	u1234567	**	kWh
		401	4000	u12345.67	**	MWh
		4001	40000	u123456.7	**	MWh
		40001	100000	u1234567	**	MWh

\* An additional place to the right of the decimal point is included for the calibration display in the case of a main display which can be calibrated (Q0 or Q9). The leading digit is thus eliminated in the case of an 8-place display.

\*\* In the case of Q1, the secondary display can be calibrated  $\underline{\underline{\leq}}$  Q0, for which reason display overflow is based on the secondary display. The normal display is shifted one place to the left if necessary.

**7.2 TEST LEDS**

The test LEDs are located above the control keys. The left LED indicates energy export and the right LED indicates energy import. Blinking frequency accelerates as the measured power value increases. If all currents are smaller than starting current, both LEDs light up continuously.

**LED Constant**

Direct meters EM2281, EM2289: 10,000 pls/kWh  
 Transformer meters EM2381, EM2387, EM2389: 100,000 pls/kWh

**7.3 KEYS**

This chapter only describes the general functions of the various keys as required for basic understanding. Detailed procedures can be found in ⇨ "Configuration and Operation" 34.

**7.3.1 UP AND ENTER**

The **UP** and **ENTER** keys can be used to switch back and forth amongst the various displays (e.g. view of momentary values and selected parameter settings). If neither of the keys is pressed for a period of 1 minute, the meter is returned automatically to its standard display.

Depending on the instrument and its features, the two keys can also be used to adjust parameters (if the **enable key** has been pressed beforehand ⇨ 33).



### 7.3.2 ENABLE KEY

The enable key makes it possible to enable or disable parameter changes.

It's located behind the top terminal cover between terminals 21 and 22. See "Instrument Overview" → 10.

The enable key can be activated with a pointed object (e.g. an ESD safe screwdriver).

 **DANGER**

**Slipping and touching the screw terminals.**  
**Electric shock due to live components!**  
**Life endangering due to electric arcs!**





Touching voltage conducting components is life endangering!

- The terminal cover must be closed.
- Use an ESD safe screwdriver, another insulated tool or a non-conductive object.

**ATTENTION**

**Pointed Objects**

Pointed objects may damage the key.  
Be careful when pressing the enable key with a pointed object.

- |                |  |   |
|----------------|--|---|
| <b>Enable</b>  | Pressing the enable key activates the "change parameters" operating mode:      |  →  (key off) |
| <b>Disable</b> | Pressing the enable key again disables the "change parameters" operating mode: |  →  (key on)  |

If no keys are pressed for a period of about 2 minutes, the "change parameters" operating mode is exited automatically and disabled (key on).

## 8 CONFIGURATION AND OPERATION

The standard display (active energy and active power import) appears by default:

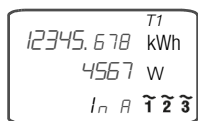

Accuracy of active energy  $EP_1 \dots EP_8, EP_{tot}$  (kWh):  $\pm 1\%$

Accuracy of active power  $P_1, P_2, P_3, P_{tot}$  (kW):  $1\% \pm 1 d$

The **ENTER** and **UP** keys ( $\Rightarrow$  32) can be used to switch from the standard display to other displays or menus. The following assumes that the standard display is active and describes how to “cycle through” the display from there.

### Note

The displays and menus are dependent on the included features and may thus not be available on your instrument.  
Feature-dependent displays and menus are identified in this section with a light gray color and the feature designation.

### Display (viewing values)

Different values can be displayed. Which values are displayed is feature-dependent.

Measuring Function	Accuracy	Display (feature)				
		M0	M1	M2 <sup>a</sup>	M3 <sup>b</sup>	
Measured Quantity	(at ref. cond.)					
Active energy (kWh) <sup>c</sup>	$EP_1 \dots EP_8, EP_{tot}$	$\pm 1\%$	•	•	•	•
Reactive energy (kVArh) <sup>d</sup>	$EQ_{tot}$	$\pm 2\%$	—	—	•	•
Star voltage (V)	$U_{1N}, U_{2N}, U_{3N}$	$0.5\% \pm 1 d$	—	•	—	•
Delta voltage (V)	$U_{12}, U_{23}, U_{13}$	$0.5\% \pm 1 d$	—	•	—	•
Current per phase (A)	$I_1, I_2, I_3$	$0.5\% \pm 1 d$	—	•	—	•
Neutral conductor current (A)	$I_N^e$	$1\% \pm 1 d$ , typical	—	•	—	•
Active power (kW)	$P_1, P_2, P_3, P_{tot}$	$1\% \pm 1 d$	—	•	—	•
Reactive power (kVAr)	$Q1, Q2, Q3, Q_{tot}$	$1\% \pm 1 d$	—	•	—	•
Apparent power (kVA)	$S_1, S_2, S_3, S_{tot}$	$1\% \pm 1 d$	—	•	—	•
Power factor (cos $\phi$ )	$PF_1, PF_2, PF_3, PF_{tot}$	$1\% \pm 1 d$	—	•	—	•
Frequency (Hz)	$f$	$0.05\% \pm 1 d$	—	•	—	•
RMS distortion value	THD $U_1, U_2, U_3$		—	•	—	•
	THD $I_1, I_2, I_3$		—	•	—	•

a. Not approved for billing purposes in Switzerland

b. Not approved for billing purposes in Switzerland

c. Total power (kW/kVAr) appears at auxiliary display 2 with plus or minus sign

d. Total power (kW/kVAr) appears at auxiliary display 2 with plus or minus sign

e. The greatest current value per phase is used as a reference value for accuracy.

When displaying values, the display is backlit in white (exception: red when displaying firmware version)  $\Rightarrow$  "Display" 30.

### Settings

The following parameters can be changed:

- All instruments with feature V2 or V4: S0
- EM2381 / EM2387 / EM2389 with feature Q1: CT and VT
- Further parameters in accordance with the instrument's interface (model and feature-dependent).

The display is backlit in pink in menus to which settings can be entered  $\Rightarrow$  "Display" 30.

**Which values do you want to display or which parameters do you want to adjust?**

- ⇨ "Transformation Ratio (EM2381, EM2387 and EM2389 only)" 47
- ⇨ "Switching Amongst Tariffs" 36
- ⇨ "Power Displays (feature M1/M3 only)" 40
- ⇨ "Mains Monitor (only with feature M1/M3)" 42
- ⇨ "SO Pulse Output (only with feature W0)" 44
- ⇨ "Transformation Ratio (EM2381, EM2387 and EM2389 only)" 47
- ⇨ "Bus Connections (features W1, W2, W4, W7)" 49
- ⇨ "Meter Reading Profile" 49
- ⇨ "Display Test" 51
- ⇨ "Firmware Version" 51
- ⇨ "Calibration Display" 52

**8.1 DISPLAY OF ACTIVE AND REACTIVE ENERGY, AS WELL AS ACTIVE AND REACTIVE POWER**

The various values are shown in successive displays. As a result, you may have to cycle through multiple displays. The linear path is described on the left. In contrast, the absolute number of keys required from the starting point to the desired display is shown on the right in the various sections.

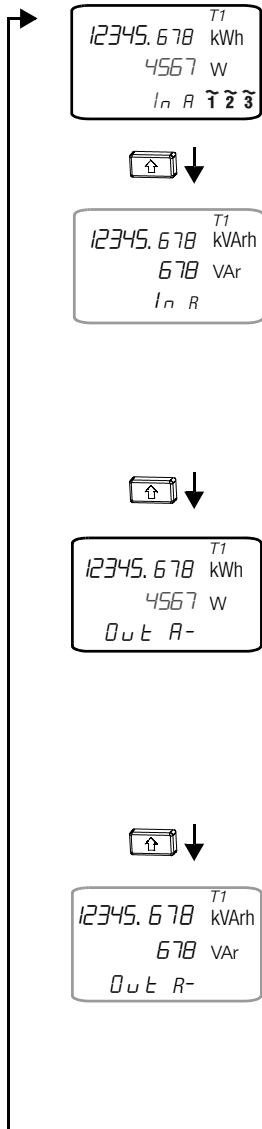

The standard display is the starting point.

**8.1.1 DISPLAYING INDUCTIVE REACTIVE ENERGY AND REACTIVE POWER (ONLY WITH FEATURE M2/M3)**

For the currently selected tariff.  
 Accuracy of reactive energy  $EQ_1 \dots EQ_8, EQ_{tot}$  (kVArh):  $\pm 2\%$   
 Accuracy of reactive power  $Q_1, Q_2, Q_3, Q_{tot}$  (kVAr):  $1\% \pm 1 d$

**► Procedure**

1. Briefly press the **UP** key.
- ↳ Inductive reactive energy and inductive reactive power are displayed.

**8.1.2 DISPLAYING ACTIVE ENERGY AND ACTIVE POWER EXPORT**

For the currently selected tariff.  
 Accuracy of active energy  $EP_1 \dots EP_8, EP_{tot}$  (kWh):  $\pm 1\%$   
 Accuracy of active power  $P_1, P_2, P_3, P_{tot}$  (kW):  $1\% \pm 1 d$

**► Procedure**

1. Briefly press the **UP** key.  
 For instruments with feature M2/M3: Briefly press the **UP** key twice in succession at short intervals.
- ↳ Active energy and active power export are displayed.

**8.1.3 DISPLAYING CAPACITIVE REACTIVE ENERGY AND REACTIVE POWER (ONLY WITH FEATURE M2/M3)**

For the currently selected tariff.  
 Accuracy of reactive energy  $EQ_1 \dots EQ_8, EQ_{tot}$  (kVArh):  $\pm 2\%$   
 Accuracy of reactive power  $Q_1, Q_2, Q_3, Q_{tot}$  (kVAr):  $1\% \pm 1 d$

**► Procedure**

1. Briefly press the **UP** key 3 times in succession at short intervals.
- ↳ Capacitive reactive energy and reactive power export are displayed.

Continued on next page.

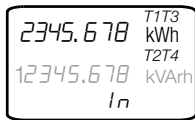

### 8.1.4 DISPLAYING TOTAL ACTIVE ENERGY IMPORT (ALL) AND REACTIVE ENERGY IMPORT (ONLY WITH FEATURE M2/M3)

For all tariffs.

Accuracy of active energy  $EP_1 \dots EP_8, EP_{tot}$  (kWh):  $\pm 1\%$

Accuracy of reactive energy  $EQ_1 \dots EQ_8, EQ_{tot}$  (kVArh):  $\pm 2\%$

► **Procedure**

1. Briefly press the **UP** key twice in succession at short intervals.  
For instruments with feature M2/M3: Briefly press the **UP** key 4 times in succession at short intervals.

↳ Total active energy import is displayed.  
In the case of instruments with feature M2/M3, total reactive energy import is also displayed.

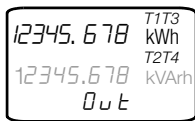

### 8.1.5 DISPLAYING TOTAL ACTIVE ENERGY EXPORT (ALL) AND REACTIVE ENERGY IMPORT (ONLY WITH FEATURE M2/M3)

For all tariffs.

Accuracy of active energy  $EP_1 \dots EP_8, EP_{tot}$  (kWh):  $\pm 1\%$

Accuracy of reactive energy  $EQ_1 \dots EQ_8, EQ_{tot}$  (kVArh):  $\pm 2\%$

► **Procedure**

1. Briefly press the **UP** key 3 times in succession at short intervals.  
For instruments with feature M2/M3: Briefly press the **UP** key 5 times in succession at short intervals.

↳ Total active energy export is displayed.  
In the case of instruments with feature M2/M3, total reactive energy export is also displayed.



Briefly press the **UP** key or wait for one minute in order to switch to the standard display.

## 8.2 SWITCHING AMONGST TARIFFS

All instruments are equipped with 4 hardware-controlled tariff inputs. Instruments with bus (features W1, W2, W4, W7) have 4 additional software-controlled tariffs (not included in the scope of MID approval).

### 8.2.1 DISPLAYING ACTIVE ENERGY AND REACTIVE ENERGY (ONLY WITH FEATURE M2, M3)

The various tariffs are shown in successive displays. As a result, you may have to cycle through multiple displays. Active energy is displayed for each tariff, and reactive energy is also displayed for instruments with feature M2 or M3.

Accuracy of active energy  $EP_1 \dots EP_8, EP_{tot}$  (kWh):  $\pm 1\%$

Accuracy of reactive energy  $EQ_1 \dots EQ_8, EQ_{tot}$  (kVArh):  $\pm 2\%$

The linear path is described at the left on the next page. In contrast, the absolute number of keys required from the starting point to the desired display is shown on the right in the various sections.

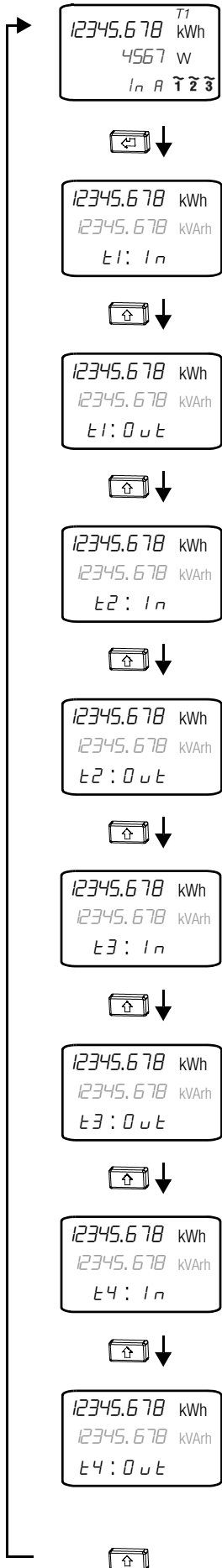

The standard display is the starting point.

► **Tariff 1 (T1) – Import**

1. Briefly press the **ENTER** key.
- ↳ Active energy import is displayed for tariff 1.  
In the case of feature M2/M3, reactive energy import is also displayed for tariff 1.

► **Tariff 1 (T1) – Export**

1. Briefly press the **ENTER** key.
2. Briefly press the **UP** key.
- ↳ Active energy export is displayed for tariff 1.  
In the case of feature M2/M3, reactive energy export is also displayed for tariff 1.

► **Tariff 2 (T2) – Import**

1. Briefly press the **ENTER** key.
2. Press the **UP** key twice in succession at short intervals.
- ↳ Active energy import is displayed for tariff 3.  
In the case of feature M2/M3, reactive energy import is also displayed for tariff 2.

► **Tariff 2 (T2) – Export**

1. Briefly press the **ENTER** key.
2. Press the **UP** key 3 times in succession at short intervals.
- ↳ Active energy export is displayed for tariff 2.  
In the case of feature M2/M3, reactive energy export is also displayed for tariff 2.

► **Tariff 3 (T3) – Import**

1. Briefly press the **ENTER** key.
2. Press the **UP** key 4 times in succession at short intervals.
- ↳ Active energy import is displayed for tariff 3.  
In the case of feature M2/M3, reactive energy import is also displayed for tariff 3.

► **Tariff 3 (T3) – Export**

1. Briefly press the **ENTER** key.
2. Press the **UP** key 5 times in succession at short intervals.
- ↳ Active energy export is displayed for tariff 3.  
In the case of feature M2/M3, reactive energy export is also displayed for tariff 3.

► **Tariff 4 (T4) – Import**

1. Briefly press the **ENTER** key.
2. Press the **UP** key 5 times in succession at short intervals.
- ↳ Active energy import is displayed for tariff 4.  
In the case of feature M2/M3, reactive energy import is also displayed for tariff 4.

► **Tariff 4 (T4) – Export**

1. Briefly press the **ENTER** key.
2. Press the **UP** key 6 times in succession at short intervals.
- ↳ Active energy export is displayed for tariff 4.  
In the case of feature M2/M3, reactive energy export is also displayed for tariff 4.

► **Use the same procedure for tariffs 5, 6, 7 and 8.**

Briefly press the **UP** key or wait for one minute in order to switch to the standard display.

## 8.2.2 DISPLAYING TOTAL ACTIVE ENERGY AND TOTAL REACTIVE ENERGY IMPORT (ONLY WITH FEATURE M2, M3)

The various tariffs are shown in successive displays. As a result, you may have to cycle through multiple displays. Total active energy import is displayed for each tariff, and total reactive energy import is also displayed for instruments with feature M2 or M3. In combination with feature Q1, this secondary display is calibrated.

Accuracy of active energy  $EP_1 \dots EP_8, EP_{tot}$  (kWh):  $\pm 1\%$

Accuracy of reactive energy  $EQ_1 \dots EQ_8, EQ_{tot}$  (kVAh):  $\pm 2\%$

The linear path is described on the left. In contrast, the absolute number of keys required from the starting point to the desired display is shown on the right in the various sections.

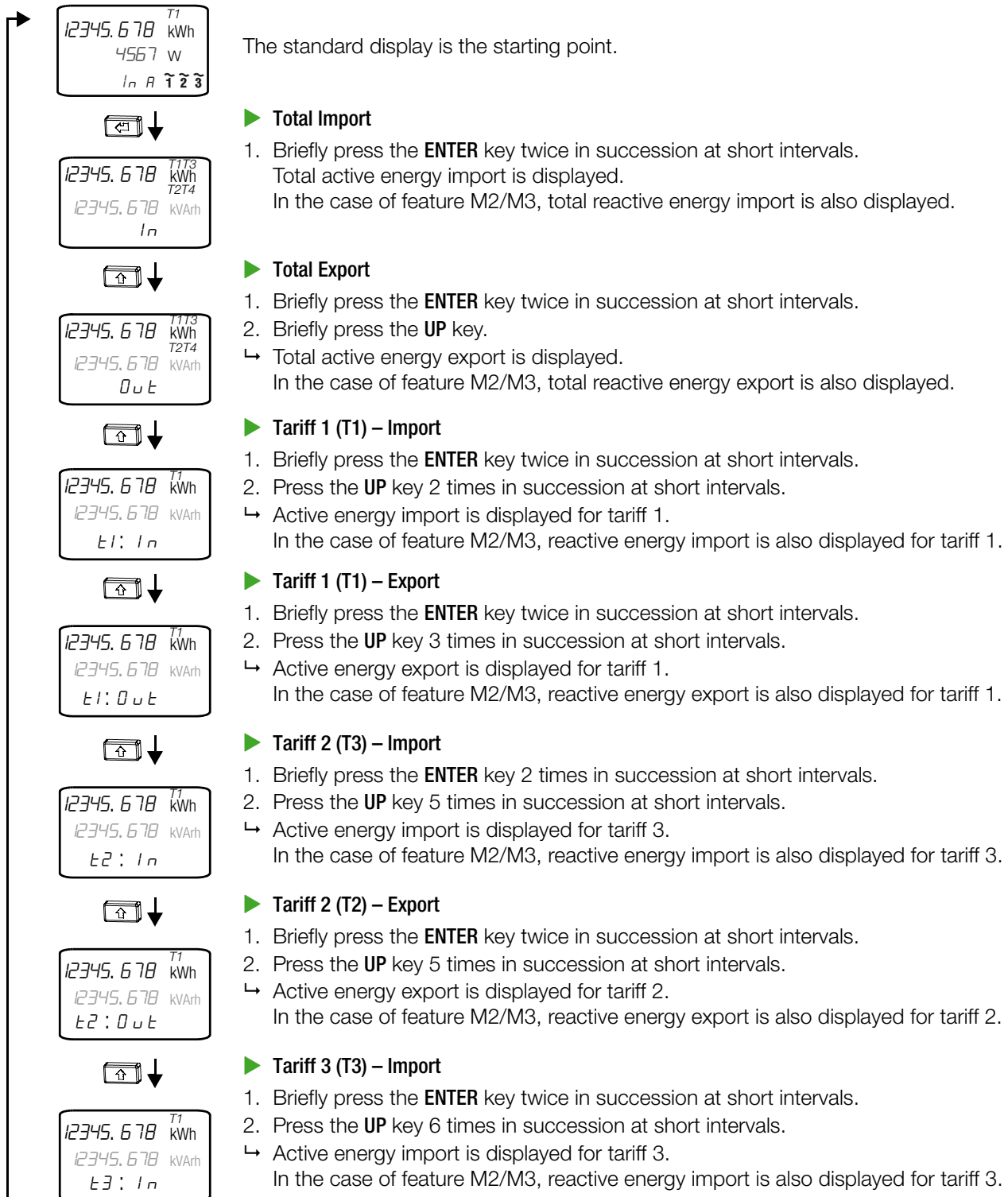

Continued on next page.



► **Tariff 3 (T3) – Export**

1. Briefly press the **ENTER** key twice in succession at short intervals.
  2. Press the **UP** key 6 times in succession at short intervals.
- ↳ Active energy export is displayed for tariff 3.  
In the case of feature M2/M3, reactive energy export is also displayed for tariff 3.



► **Tariff 4 (T4) – Import**

1. Briefly press the **ENTER** key twice in succession at short intervals.
  2. Press the **UP** key 7 times in succession at short intervals.
- ↳ Active energy import is displayed for tariff 3.  
In the case of feature M2/M3, reactive energy import is also displayed for tariff 3.

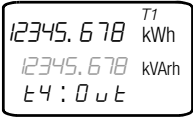

► **Tariff 4 (T4) – Export**

1. Briefly press the **ENTER** key twice in succession at short intervals.
  2. Press the **UP** key 8 times in succession at short intervals.
- ↳ Active energy export is displayed for tariff 3.  
In the case of feature M2/M3, reactive energy export is also displayed for tariff 3.

► **Use the same procedure for tariffs 5, 6, 7 and 8.**



Briefly press the **UP** key or wait for one minute in order to switch to the standard display.

### 8.3 POWER DISPLAYS (FEATURE M1/M3 ONLY)

Available displays differ according to the number of conductors.

#### 8.3.1 4-WIRE DISPLAYS

The various values are shown in successive displays. As a result, you may have to cycle through multiple displays.

The linear path is described on the left. In contrast, the absolute number of keys required from the starting point to the desired display is shown on the right in the various sections.

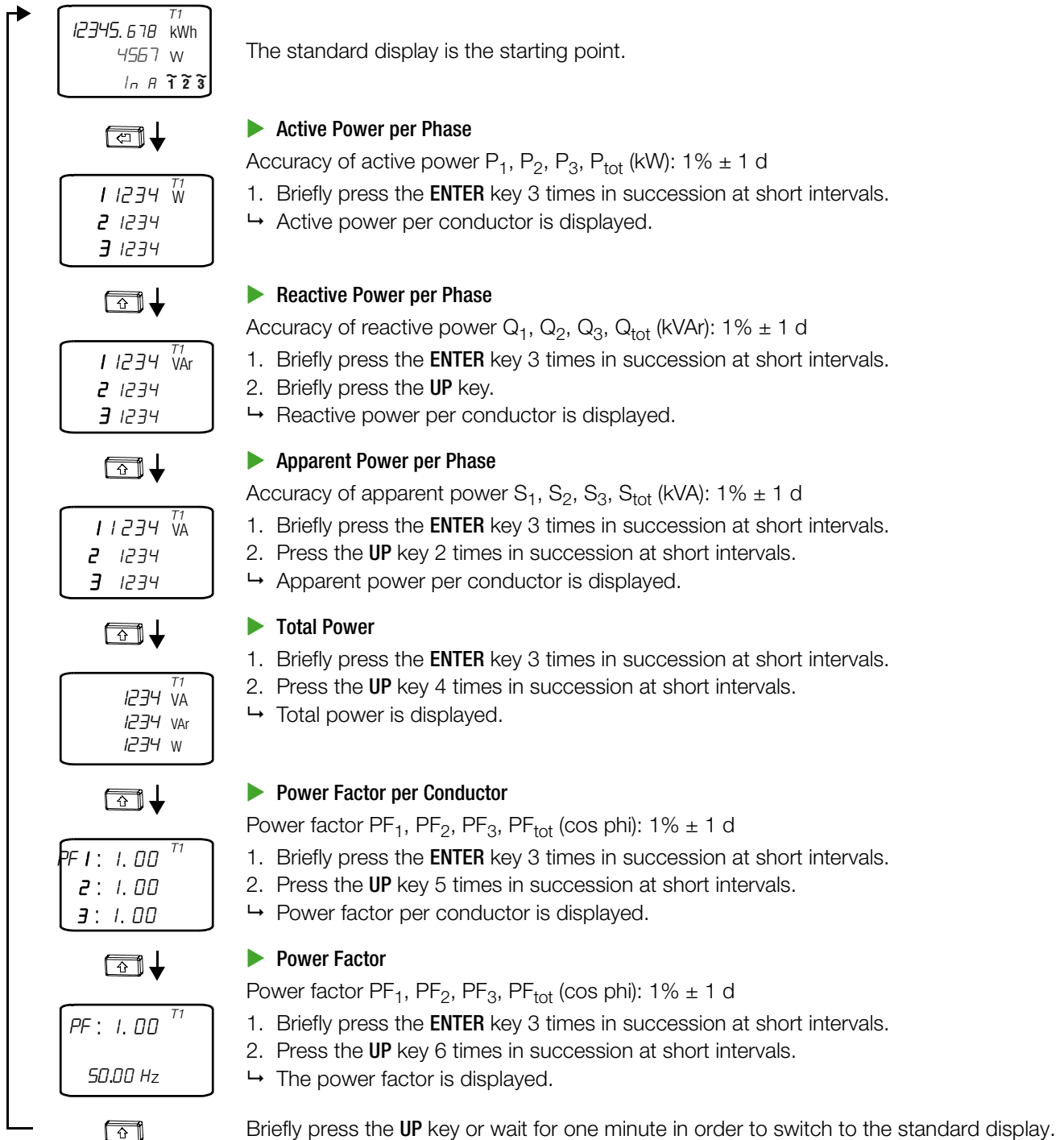



### 8.3.2 3-WIRE DISPLAYS

The various values are shown in successive displays. As a result, you may have to cycle through multiple displays.

The linear path is described on the left. In contrast, the absolute number of keys required from the starting point to the desired display is shown on the right in the various sections.

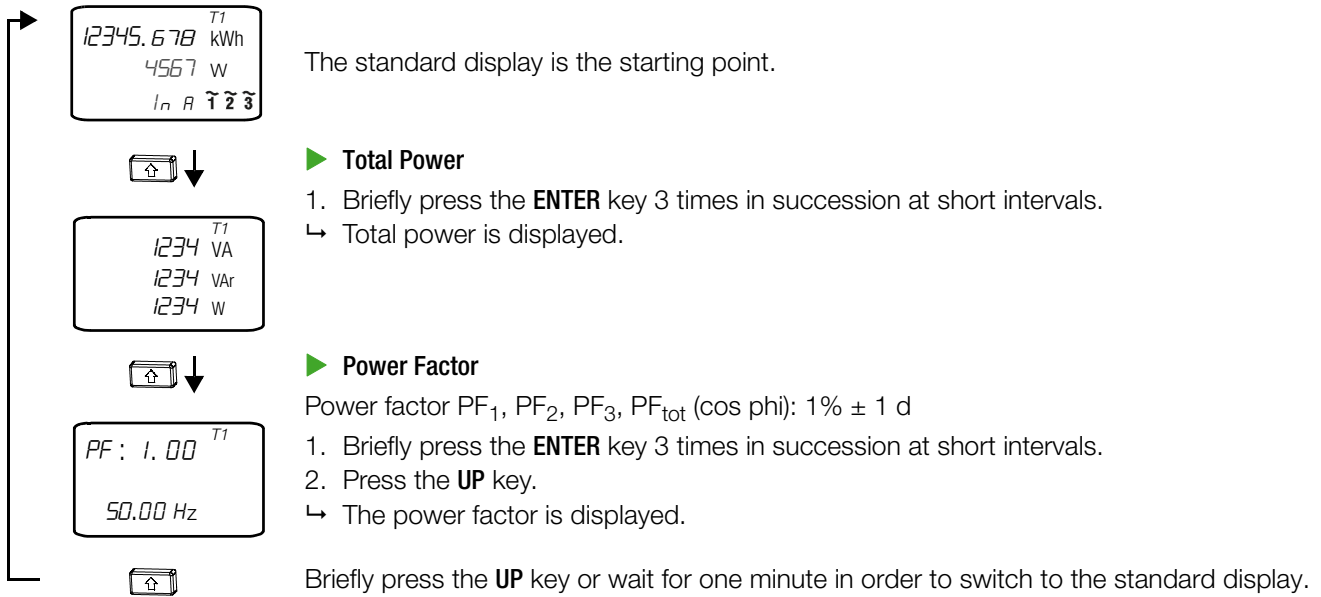

### 8.3.3 2-WIRE DISPLAYS

The various values are shown in successive displays. As a result, you may have to cycle through multiple displays.

The linear path is described on the left. In contrast, the absolute number of keys required from the starting point to the desired display is shown on the right in the various sections.

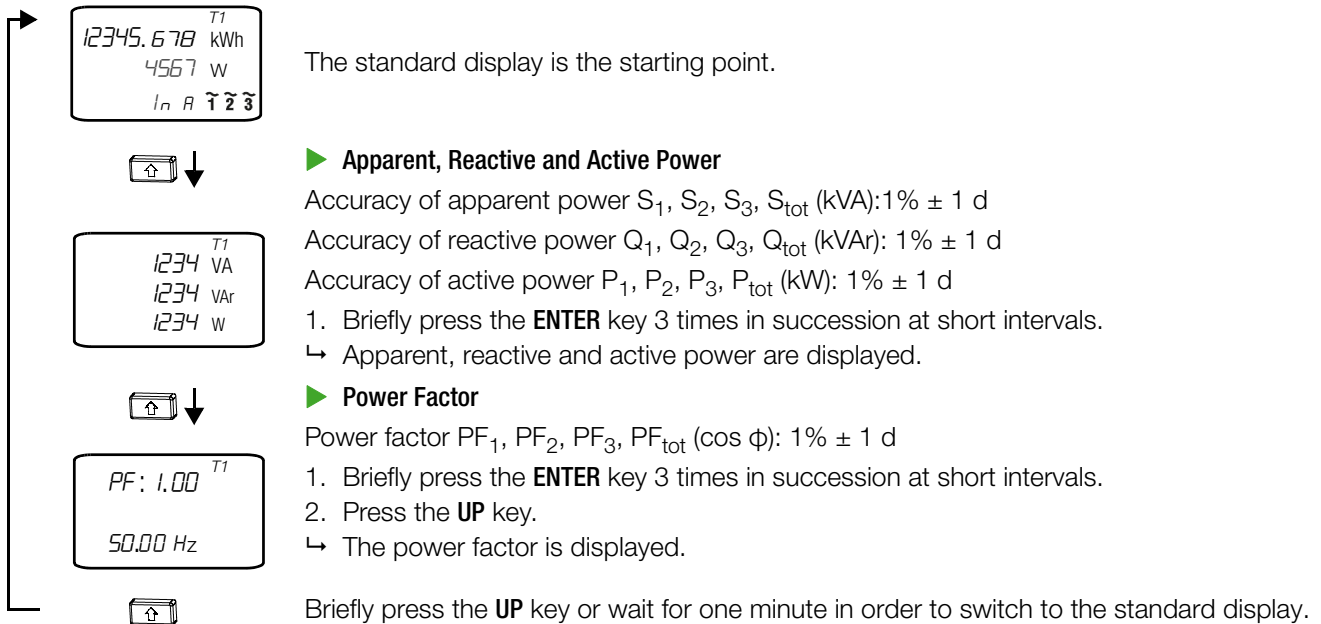

## 8.4 MAINS MONITOR (ONLY WITH FEATURE M1/M3)

### 8.4.1 4-WIRE DISPLAYS

The various values are shown in successive displays. As a result, you may have to cycle through multiple displays. The linear path is described on the left. In contrast, the absolute number of keys required from the starting point to the desired display is shown on the right in the various sections.

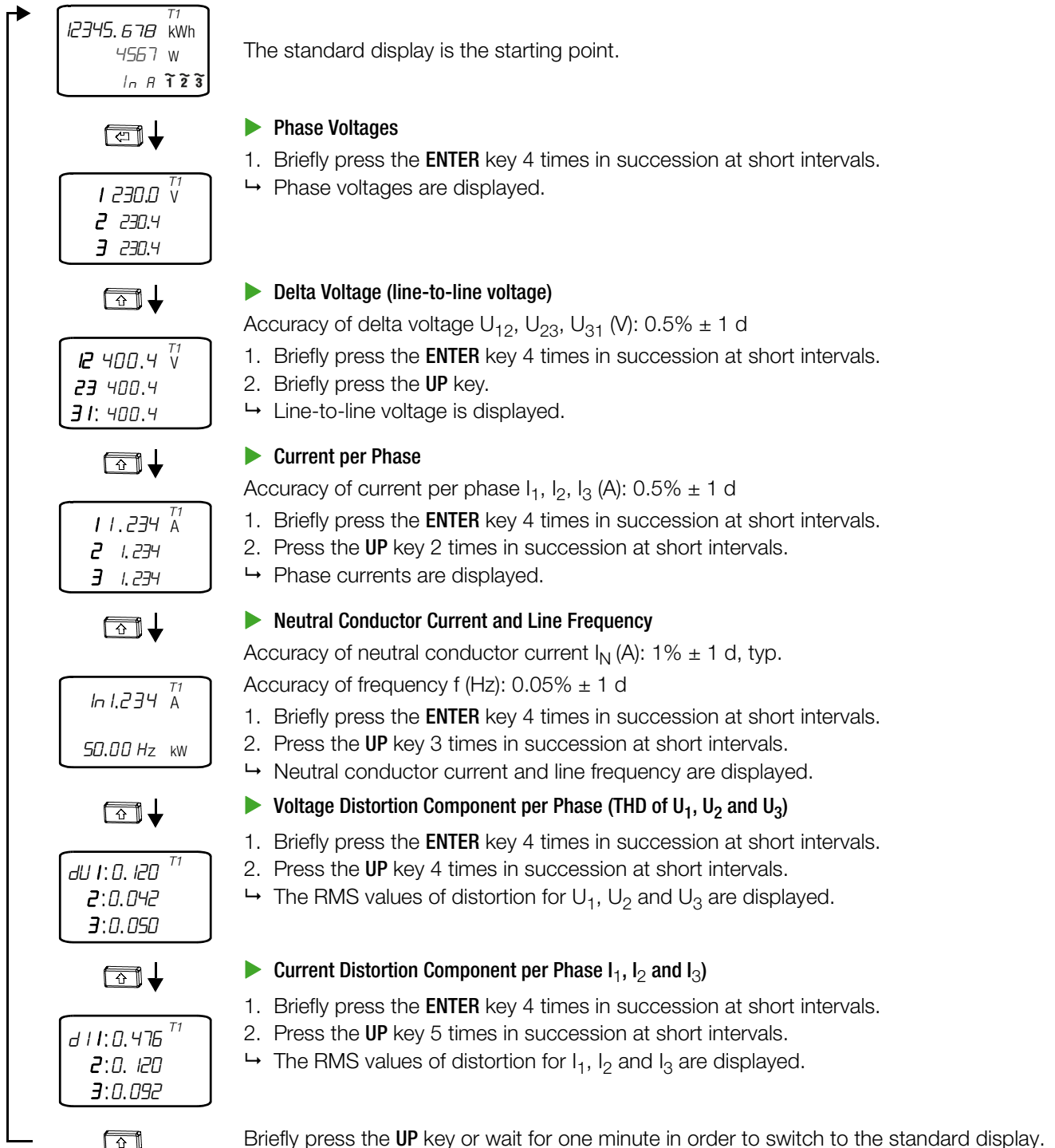

### 8.4.2 3-WIRE DISPLAYS

The various values are shown in successive displays. As a result, you may have to cycle through multiple displays.

The linear path is described on the left. In contrast, the absolute number of keys required from the starting point to the desired display is shown on the right in the various sections.

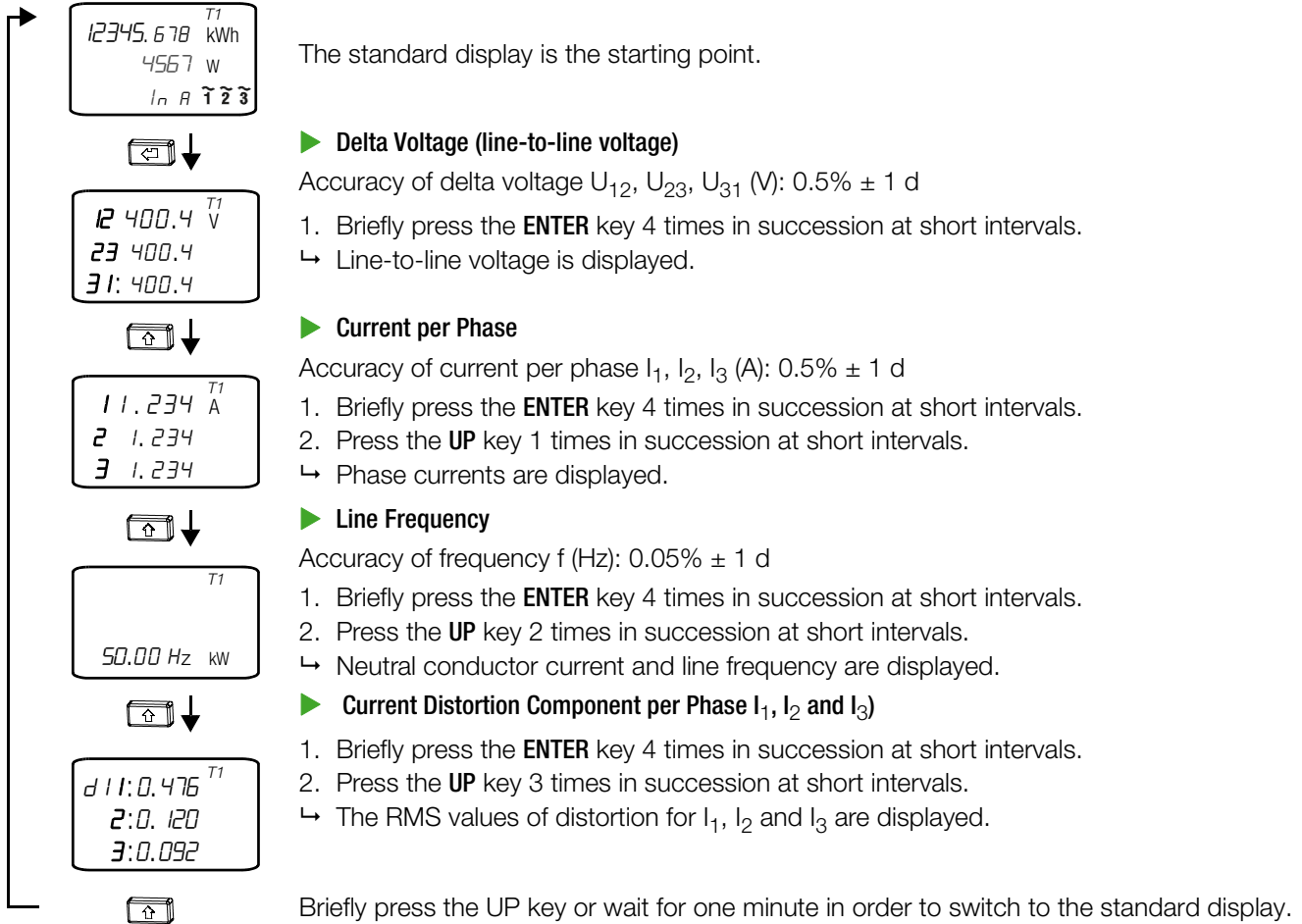

### 8.4.3 2-WIRE DISPLAYS

The various values are shown in successive displays. As a result, you may have to cycle through multiple displays. The linear path is described on the left. In contrast, the absolute number of keys required from the starting point to the desired display is shown on the right in the various sections.

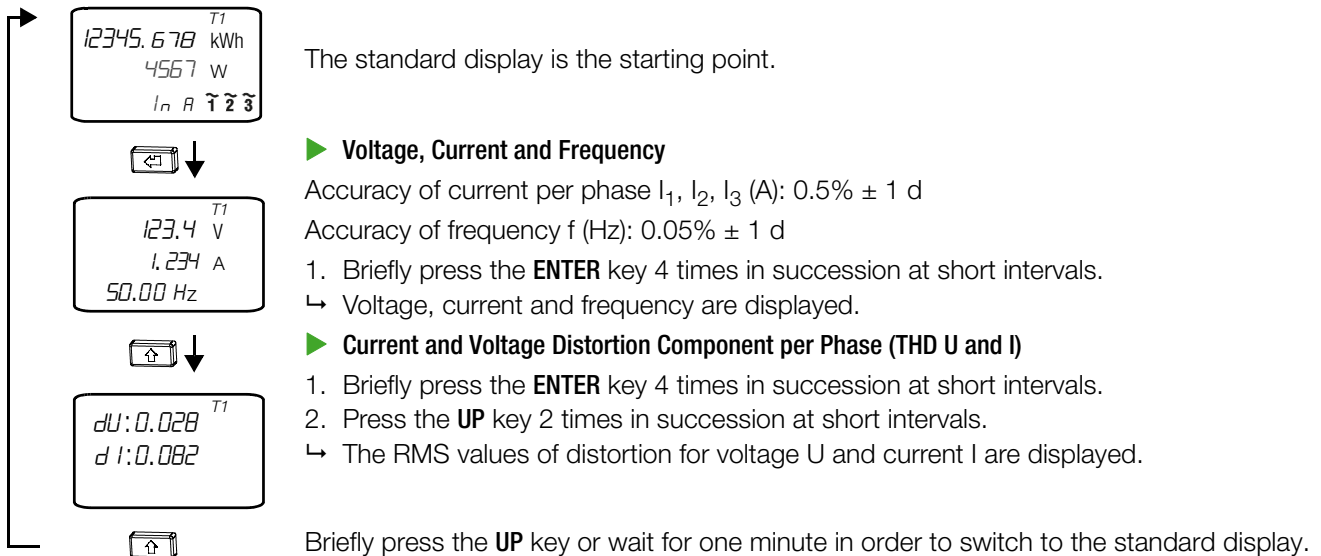

## 8.5 S0 PULSE OUTPUT (ONLY WITH FEATURE W0)

The linear path is described on the left. In contrast, the absolute number of keys required from the starting point to the desired display is shown on the right in the various sections.

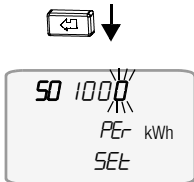
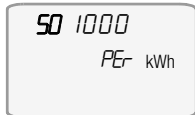

The standard display is the starting point.

### 8.5.1 DISPLAYING PULSE FREQUENCY

Pulse frequency is the number of pulses which are read out per kWh.

Default value for direct connection: 1000 pls/kWh / for transformer connection: 1000 pls/kWh (adjustable and possibly different with feature V2, V4)

#### ► Procedure

1. Press and hold the **ENTER** key.
2. Instruments with direct connection: Briefly press the **UP** key 4 times in succession at short intervals.  
Instruments with transformer connection: Briefly press the **UP** key 6 times in succession at short intervals.
- ↳ The pulse rate is displayed.

### 8.5.2 ADJUSTING PULSE FREQUENCY (ONLY WITH FEATURE V2, V4)

Pulse frequency is the number of pulses which are read out per kWh.

The adjustable value (pls/kWh) is model and feature-dependent:

V2/V4 – direct connection: 1 ... 1000 pls/kWh

V2/V4 – current transformer connection: 1 ... 50,000 pls/kWh

Consider the mutual dependence of pulse frequency and pulse duration when selecting a value.

#### ► Procedure

1. Press and hold the **ENTER** key.
2. Instruments with direct connection: Briefly press the **UP** key 4 times in succession at short intervals.  
Instruments with transformer connection: Briefly press the **UP** key 6 times in succession at short intervals.  
↳ Pulse frequency is displayed.
3. Press the **Enable** key.  
↳ The pulse frequency parameter is enabled: changes to . The blinking cursor which then appears marks the entry position.
4. Enter the new pulse frequency:  
Change the currently blinking number with the help of the **UP** key.  
Switch to the next entry position by pressing the **ENTER** key.
5. Acknowledge the last number by pressing the **ENTER** key.  
SRU, nU appears briefly at auxiliary display 2. Pulse frequency has been changed.
6. Press the **Enable** key.  
↳ The pulse frequency parameter is disabled: changes to .  
↳ The edited pulse frequency is saved and the parameter is disabled.

Continued on next page.



### 8.5.3 DISPLAYING PULSE DURATION

Pulse duration is the duration of the pulse for the ON state or HIGH value.  
Standard: 30 ms (adjustable and possibly different with feature V2, V4)

► **Procedure**

1. Press and hold the **ENTER** key.
2. Instruments with direct connection: Briefly press the **UP** key 5 times in succession at short intervals.  
Instruments with transformer connection: Briefly press the **UP** key 7 times in succession at short intervals.
- ↳ Pulse duration is displayed.

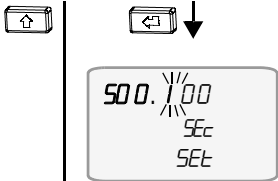

### 8.5.4 ADJUSTING PULSE DURATION (ONLY WITH FEATURE V2, V4)

Pulse duration is the duration of the pulse for the ON state or HIGH value. Adjustable: 30 ms ... 3 s (accuracy: ± 5%). Recommendation in case of processing problems: 70 ms.  
Consider the mutual dependence of pulse frequency and pulse duration when selecting a value.

► **Procedure**

1. Press and hold the **ENTER** key.
2. Instruments with direct connection: Briefly press the **UP** key 5 times in succession at short intervals.  
Instruments with transformer connection: Briefly press the **UP** key 7 times in succession at short intervals.  
↳ Pulse duration is displayed.
3. Press the **Enable** key.  
↳ The pulse duration parameter is enabled: changes to . The blinking cursor which then appears marks the entry position.
4. Enter the new pulse duration:  
Change the currently blinking number with the help of the **UP** key.  
Switch to the next entry position by pressing the **ENTER** key.
5. Acknowledge the last number by pressing the **ENTER** key.  
↳ *SAL<sub>1</sub> nG* appears briefly at auxiliary display 2. Pulse duration has been changed.
6. Press the **Enable** key.  
↳ The pulse duration parameter is disabled: changes to .  
↳ The edited pulse duration is saved and the parameter is disabled.

### 8.5.5 DISPLAYING THE PULSE SOURCE

There are 4 pulse sources for pulse outputs S01 and S02:

- Active energy import in kWh
- Active energy export in – kWh
- Reactive energy import in kVAr
- Reactive energy export in – kVAr

► **Procedure**

1. Press and hold the **ENTER** key.
2. Instruments with direct connection: Briefly press the **UP** key 6 times in succession at short intervals.  
Instruments with transformer connection: Briefly press the **UP** key 8 times in succession at short intervals.
- ↳ The pulse source is displayed.



Continued on next page.

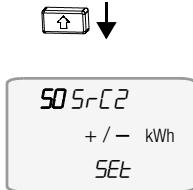
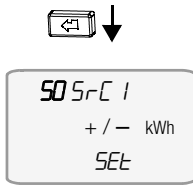

Long →





### 8.5.6 SELECTING PULSE SOURCES (ONLY WITH FEATURE V2, V4)

4 pulse sources for pulse outputs S01 and S02:

- Active energy import *FHH* or export *-FHH*
- Reactive energy import *FURr* or export *-FURr*

2 states: The S0 switch is either *CLoSEd* or *OPEN*.

► **Procedure**

1. Press and hold the **ENTER** key.
2. Instruments with direct connection: Briefly press the **UP** key 5 times in succession at short intervals.  
Instruments with transformer connection: Briefly press the **UP** key 7 times in succession at short intervals.  
↳ The pulse source is displayed.
3. Press the **Enable** key.  
↳ The pulse source parameter is enabled:  changes to .
4. Briefly press the **ENTER** key.  
↳ The blinking cursor which then appears marks the entry position.
5. Enter the new pulse source:  
Change the currently blinking state with the help of the **UP** key.
6. Acknowledge the state by pressing the **ENTER** key.  
↳ *SRLi nG* appears briefly at auxiliary display 2. Pulse source 1 is changed.
7. Briefly press the **UP** key.
8. Briefly press the **ENTER** key.  
↳ The blinking cursor which then appears marks the entry position.
9. Enter the new pulse source:  
Change the currently blinking state with the help of the **UP** key.
10. Acknowledge the state by pressing the **ENTER** key.  
↳ *SRLi nG* appears briefly at auxiliary display 2. Pulse source 2 is changed.
11. Press the **Enable** key.  
↳ The pulse source parameter is disabled:  changes to .

↳ The edited pulse source is saved and the parameter is disabled.

Briefly press the **UP** key or wait for one minute in order to switch to the standard display.

⇒ "Firmware Version"  51

## 8.6 TRANSFORMATION RATIO (EM2381, EM2387 AND EM2389 ONLY)

In the case of meters with transformer connection, the transformation ratios of the current transformer (CT) and the voltage transformer (VT) can be viewed.

The linear path is described on the left. In contrast, the absolute number of keys required from the starting point to the desired display is shown on the right in the various sections.

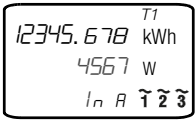

The standard display is the starting point.



### 8.6.1 DISPLAYING THE CURRENT TRANSFORMATION RATIO (CT)

Standard:

Q0:  $CT = VT = 1$

Q1: adjustable ( $CT \times VT \leq 100,000$ )

Q9: fixed individually (default:  $QCT = 1 \dots 10000$ ,  $QVT = 1 \dots 1000$ ,  $CT \times VT \leq 1,000,000$ )

#### ► Procedure

1. Press and hold the **ENTER** key.
2. Briefly press the **UP** key 3 times in succession at short intervals.  
↳ The CT value is displayed.

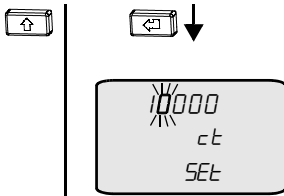

### 8.6.2 SETTING THE CURRENT TRANSFORMATION RATIO (CT) (ONLY WITH FEATURE Q1)

Adjustable:  $CT \times VT \leq 100,000$

#### ► Procedure

1. Press and hold the **ENTER** key.
  2. Briefly press the **UP** key 3 times in succession at short intervals.  
↳ The CT value is displayed.
  3. Press the **Enable** key.  
↳ The CT parameter is enabled: changes to .
  4. Briefly press the **ENTER** key.  
↳ The blinking cursor which then appears marks the entry position.
  5. Enter the new CT value:  
Change the currently blinking number with the help of the **UP** key.  
Switch to the next entry position by pressing the **ENTER** key.
  6. Acknowledge the last number by pressing the **ENTER** key.  
↳ *SAVE OK* appears briefly at auxiliary display 2. The CT value is changed.
  7. Press the **Enable** key.  
↳ The CT parameter is disabled: changes to .
- ↳ The edited CT value is saved and the parameter is disabled.

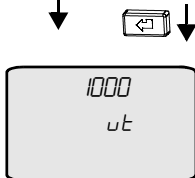

### 8.6.3 DISPLAYING THE VOLTAGE TRANSFORMATION RATIO (VT)

Standard:

Q0:  $CT = VT = 1$

Q1: adjustable ( $CT \times VT \leq 100,000$ )

Q9: fixed individually (default:  $QCT = 1 \dots 10000$ ,  $QVT = 1 \dots 1000$ ,  $CT \times VT \leq 1,000,000$ )

#### ► Procedure

1. Press and hold the **ENTER** key.
2. Briefly press the **UP** key 4 times in succession at short intervals.  
↳ The VT value is displayed.



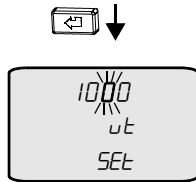

Continued on next page.



### 8.6.4 SETTING THE VOLTAGE TRANSFORMATION RATIO (VT) (ONLY WITH FEATURE Q1)

Adjustable:  $CT \times VT \leq 100,000$

► **Procedure**

1. Press and hold the **ENTER** key.
2. Briefly press the **UP** key 4 times in succession at short intervals.
  - ↳ The VT value is displayed.
3. Press the **Enable** key.
  - ↳ The VT parameter is enabled:  changes to .
4. Briefly press the **ENTER** key.
  - ↳ The blinking cursor which then appears marks the entry position.
5. Enter the new VT value:
  - Change the currently blinking number with the help of the **UP** key.
  - Switch to the next entry position by pressing the **ENTER** key.
6. Acknowledge the last number by pressing the **ENTER** key.
  - ↳ *SRU, nU* appears briefly at auxiliary display 2. The VT value is changed.
7. Press the **Enable** key.
  - ↳ The VT parameter is disabled:  changes to .
  - ↳ The edited VT value is saved and the parameter is disabled.

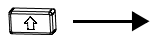

⇒ "S0 Pulse Output (only with feature W0)" 44



## 8.7 BUS CONNECTIONS (FEATURES W1, W2, W4, W7)

There are separate menus and setting options for all bus connections. Their descriptions are comprehensive and are made available in separate documents, i.e. the interface descriptions: LON-Bus (W1, document number: 3-349-908-01), M-Bus (W2, document number: 3-349-909-01), Modbus RTU (W7, document number: 3-349-910-01) and TCP/IP including BACnet, Modbus TCP and HTTP (W4, document number: 3-349-937-01). These can be found at:

<https://www.gmc-instruments.de/en/services/download-center/>



## 8.8 METER READING PROFILE

Depending on the instrument variant, the meter is equipped with a meter reading profile (⇒ "Definition of Terms" 8).

- Z1: meter reading profile
- Z2: with certification per PTB-A 50.7

It stores the current meter readings of the active tariff for active and reactive power (both import and export but only active power with feature Z2) for each selected period. The consumption profile and a load profile can be determined from these data.

### 8.8.1 METER READING PROFILE Z1

This document only describes the display of meter reading profile Z1 and the increment setting. For a detailed description and setting options, please refer to the operating instructions with the title "ENERGYMID|EMEM228X and EM238X Energy Meters with Meter Reading Profile "Feature Z1"" (document number 3-349-972-01). The document is available on the Internet at:

<https://www.gmc-instruments.de/en/services/download-center/>



### Displaying Values (only with feature Z1 in combination with bus connection W1 / W2 / W4 / W7)

The following values are saved for one period: meter reading (4 energy values) with associated tariff, selected period duration, time, date and status (cumulative view of events that occurred during the integrating period or invalid value).



The standard display is the starting point.

3 or 5 x



#### ► Procedure

1. Briefly press the **ENTER** key 3 times in succession at short intervals.  
For instruments with feature M1/M3: Briefly press the **ENTER** key 5 times in succession at short intervals.  
↳ The meter reading profile is displayed.  
(line 2: period duration as dt / time as hh:mm / line 3: date as DD.MM.YY)
2. Briefly press the **UP** key in order to display older meter readings with date and time.  
↳ An additional value is displayed each time the key is pressed.

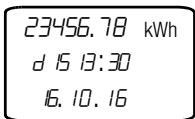

Briefly press the **UP** key or wait for one minute in order to switch to the standard display.



### Displaying and Setting Period Duration

(only with feature Z1 in combination with bus connection W1 / W2 / W4 / W7)

Period duration is the time interval at which values are stored (also called the integrating period).

The linear path is described on the left. In contrast, the absolute number of keys required from the starting point to the desired display is shown on the right in the various sections.

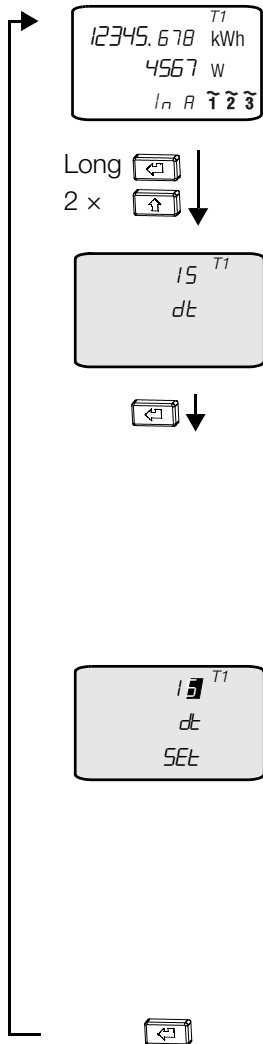

The standard display is the starting point.

#### ▶ Displaying Period Duration

1. Press and hold the **ENTER** key.
  2. Press the **UP** key 2 times in succession at short intervals.
- ↳ Period duration dt of the meter reading profile is displayed.

#### ▶ Setting Period Duration

1. Press and hold the **ENTER** key.
  2. Press the **UP** key 2 times in succession at short intervals.
- ↳ Period duration parameter is displayed.
3. Briefly press the **Enable** key.
- ↳ The period duration parameter is enabled: changes to .
4. Press and hold the **ENTER** key.
- ↳ The blinking cursor which then appears marks the entry position.
5. Set period duration. Briefly press the **UP** key to this end.
- ↳ Each time the key is pressed, the next available value in minutes is selected. The following values are possible: 1, 2, 3, 4, 5, 10, 15, 30, 60 minutes. The default value is 15 minutes. Integration takes place synchronous to clock time.
6. Acknowledge the last number by pressing the **ENTER** key.
- ↳ *SRU* *nG* appears briefly at auxiliary display 2.
7. Press the **Enable** key.
- ↳ The increment parameter is disabled: changes to .
- ↳ The edited pulse source is saved and the parameter is disabled.

Briefly press the **UP** key or wait for one minute in order to switch to the standard display.

## 8.8.2 METER READING PROFILE Z2

In the case of certified meter reading profile Z2, meter reading profile values are recorded and processed in the meter in accordance with PTB-A 50.7 and PTB-A 50.7-1. Consequently, the values can also be used for billing and acquiring 3<sup>rd</sup> party quantities.

All information and settings for meter reading profile Z2 (feature Z2) can be found in the TCP/IP interface description (document number 3-349-937-03). The document is available on the Internet at:

<https://www.gmc-instruments.de/en/services/download-center/>



## 8.9 FIRMWARE VERSION

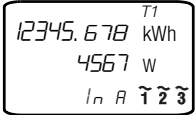

The standard display is the starting point.



### ► Displaying the Firmware Version

1. Press and hold the ENTER key.
- ↳ The firmware version is displayed with a red background.

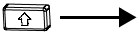

⇒ "Display Test" 51

### Note

The device firmware cannot be updated. Exception: In the case of instruments with TCP/IP interface (W4), which either don't have a meter reading profile (Z0) or are equipped with meter reading profile Z1, the interface firmware can be updated.

All pertinent information can be found in the TCP/IP interface description (document number 3-349-937-03). The document is available on the Internet at:

<https://www.gmc-instruments.de/en/services/download-center/>



## 8.10 DISPLAY TEST

You can check to determine whether or not the display is functioning correctly (all segment lines are displayed).

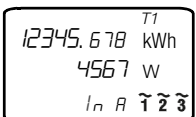

The standard display is the starting point.

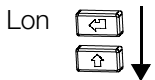

### ► Display Test Procedure

1. Press and hold the **ENTER** key.
  - ↳ The firmware version is displayed.
2. Briefly press the **UP** key.
  - ↳ The first test pattern is displayed.
3. Check to determine whether or not all segments are displayed.
4. Press the **ENTER** key in order to display the second test pattern.
5. Check to determine whether or not all segments are displayed.
6. Press the **ENTER** key again in order to display the second and third test patterns.
7. Check to determine whether or not all segments are displayed.
  - ↳ The display test has been completed.



⇒ "Calibration Display" 52

## 8.11 CALIBRATION DISPLAY

The calibration display includes an additional decimal place. Resolution is model and feature-dependent. See "Standard Display and Calibration Display" ⇨ 32.

Example: normally 100,010.00 kWh and with calibration display 100,010.005 kWh.

The linear path is described on the left. In contrast, the absolute number of keys required from the starting point to the desired display is shown on the right in the various sections.

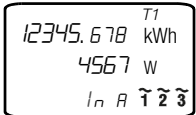

The standard display is the starting point.

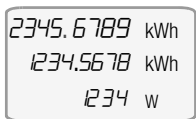
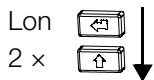

### 8.11.1 ACTIVATING THE CALIBRATION DISPLAY

► Procedure

1. Press and hold the **ENTER** key.
  2. Briefly press the **UP** key twice in succession at short intervals.
- ↳ The calibration display is activated.



### 8.11.2 PINNED CALIBRATION DISPLAY / LIVE VALUES

Active energy import and export are displayed as live values.

► Procedure

1. Press and hold the **ENTER** key.
  2. Briefly press the **UP** key twice in succession at short intervals.
  3. Briefly press the **ENTER** key.
- ↳ The calibration display is pinned and the values are displayed live.



Deactivates pinning.

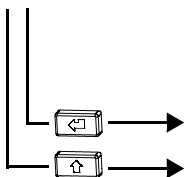

⇨ "Setting the Current Transformation Ratio (CT) (only with feature Q1)" 47

## 9 ERROR















### 9.1 POWER FAILURE

Meter parameters and meter readings are retained in internal memory (EEPROM) in the event of power failure.

### 9.2 FAULT CONDITIONS AND TROUBLESHOOTING

The instrument is equipped with an error display: if an error occurs, the display alternates between the respective error code and active energy or instantaneous power.

In the event of an error, read out the error code at the display and eliminate the error with the help of the following table:

Error Code	Meaning	Cause/Remedy
 <i>LOVOLT</i>	All phase voltages < 75%	Check connection In the case of meters with feature U3 (100 ... 110 V L-L) which also include TCP/IP bus connections (feature W4) or Modbus RTU bus connections (feature W7), background illumination and the bus connection are deactivated. Meter reading profile Z1 cannot be viewed as long as the error is pending. Meter functioning is otherwise unimpaired.
 <i>UH<sub>1</sub> 1</i>	Maximum value for U <sub>1</sub> exceeded	Check connection
 <i>UH<sub>1</sub> 2</i>	Maximum value for U <sub>2</sub> exceeded	Check connection
 <i>UH<sub>1</sub> 3</i>	Maximum value for U <sub>3</sub> exceeded	Check connection
 <i>IH<sub>1</sub> 1</i>	Maximum value for I <sub>1</sub> exceeded	Check connection
 <i>IH<sub>1</sub> 2</i>	Maximum value for I <sub>2</sub> exceeded	Check connection
 <i>IH<sub>1</sub> 3</i>	Maximum value for I <sub>3</sub> exceeded	Check connection
 <i>SYnc</i>	Frequency measuring error	Meter connected to direct voltage
 <i>CON</i>	Interface error	Check connection
 <i>ENERGY</i>	Device is defective	Send meter for repair ⇒ "Contact, Support and Service" 60
 <i>cALi b</i>	Erroneous measurement detected, balancing (calibration) required	Send meter for repair ⇒ "Contact, Support and Service" 60
 <i>ANALOG</i>	DC offset too high	Send meter for repair ⇒ "Contact, Support and Service" 60
 <i>MEMErr</i>	Memory error	Send meter for repair ⇒ "Contact, Support and Service" 60
 <i>CErE</i>	Calibration logbook	Replace meter

## 10 MAINTENANCE

The instrument is maintenance-free.

### 10.1 CLEANING

Keep outside surfaces clean. Clean the instrument with a dry cloth.



## DANGER

**Life endangering due to electric shock!**

**Life endangering due to electric arcs!**

Touching voltage conducting components is life endangering.

- Maintenance may only be carried out by trained personnel who are familiar with the dangers involved.
- The instrument and all connected conductors must be voltage-free before beginning, as well as during cleaning.

## ATTENTION

**Water and cleaning agents are unsuitable.**

Damage to the instrument.

- Use a dry cloth for cleaning.
- Avoid the use of cleansers, abrasives or solvents!

### 10.2 RECALIBRATION

The calibration period in Germany is 8 years.

## ATTENTION

**National Recalibration Regulations**

Violation of calibration law.

Comply with national recalibration regulations and laws.

Recalibration by our state-approved test laboratory (EB-8) is possible at any time.  
Contact information → "Contact, Support and Service" 60.

#### Information for the Test/Calibration Laboratory

The manufacturer's seal is located on the side of the instrument.

## ATTENTION

**Broken Manufacturer's Seal**

Violation of calibration law.

Calibration is invalidated. The instrument may not be used for billing purposes.

The instrument must be recalibrated. Send the instrument in for recalibration → "Contact, Support and Service" 60.

**ATTENTION****Tamper-Proof Sealing**

Violation of calibration law.

Seals may only be broken by authorized, qualified personnel.

- A calibration display can be activated for testing or calibration purposes, at which energy values are displayed with increased resolution ⇨ "Calibration Display" ¶52.
- In the case of direct meters, testing is only possible with sources which supply currents superimposed on voltages.
- In the case of direct meters: current and voltage paths cannot be galvanically isolated.
- Transformer meters with nominal voltage within a range of 100 to 110 V: Calibration testing at 100 V (L-L) is sufficient. The more critical power value, because roughly 9% smaller, is remeasured at all load points. Voltage influence was found to be negligible during type testing. Balancing is conducted at  $60 \text{ V} \times \sqrt[3]{}$ . Start-up is controlled internally via the current measurement only, so that voltage changes are not relevant for no-load and start-up tests.
- Transformer meters with nominal voltage within a range of 100 to 110 V: due to PTB requirements, the no-load test must be performed at 126.5 V for calibration purposes.

---

## 10.3 REPAIRS

If your instrument requires repair, please contact our service department ⇨ "Contact, Support and Service" 60.

The instruments are guaranteed for a period of 3 years after shipment. The manufacturer's guarantee covers materials and workmanship. Damage resulting from use for any other than the intended purpose or operating errors, as well as any and all consequential damage, are excluded.

### Note

#### **Loss of Warranty and Guarantee Claims**

Unauthorized modification of the instrument is prohibited. This also includes opening the meter.

If it can be ascertained that the instrument has been opened by unauthorized personnel, no guarantee claims can be honored by the manufacturer with regard to personal safety, measuring accuracy, compliance with applicable safety measures or any consequential damages.

If the manufacturer's seal (⇨ 12) is damaged or removed, all guarantee claims are rendered null and void.

- The device may only be repaired or opened by authorized, qualified personnel who are familiar with the associated dangers.
- Original replacement parts may only be installed by authorized, qualified personnel.
- Seals may only be broken or removed by authorized, qualified personnel.
- The device may not be placed back into operation until troubleshooting and repair have been performed, and recalibration and dielectric strength have been tested by an approved test laboratory (for example one of our test centers).

### Note

#### **Data Protection**

Data can be stored in the instrument. Some of these data may be sensitive. Back up your data before sending the instrument for repair.

Also, be aware of the owner's or end user's own responsibility with regard to protecting sensitive data in the instrument before sending it for repair.



## 11 REMOVAL FROM SERVICE AND DISMANTLING

The instrument cannot be switched off and must instead be disconnected from the power supply. It may only be dismantled after it has been disconnected from the power supply.



### DANGER

#### Danger of Injury

Removal from service and dismantling involve risks which may not be recognized as such by inadequately trained persons (e.g. electric shock).

- Installation may only be performed by a qualified electrician.
- Observe and comply with all safety regulations which are applicable for your work environment.
- Wear suitable and appropriate personal protective equipment (PPE) whenever working with the instrument.

### ATTENTION

#### Instrument Used for Billing Purposes

Incomplete billing or violation of legal regulations for billing energy. Property damage may also occur.

Do not remove the instrument from service or dismantle it until it can be assured that it's no longer being used for billing purposes. Consult with the operator/owner in this regard.

### 11.1 DISCONNECTION FROM THE POWER SUPPLY

Required tool: small slotted screwdriver

- ✓ You have familiarized yourself with the connections and all associated information ⇨ "Initial Startup" 21.



### DANGER

#### Electric shock due to live components!

#### Life endangering due to electric arcs!

Touching voltage conducting components is life endangering!

When removing the instrument from service, all lines connected to the meter must be voltage-free. When disconnecting, observe the five safety rules in accordance with DIN VDE 0105-100, Operation of electrical installations – Part 100: General requirements:

1. Shut down entirely.
2. Secure against restart.
3. Assure absence of voltage at all poles.
4. Ground and short circuit.
5. Cover neighboring live components, or make them inaccessible.

### ATTENTION

#### Tamper-Proof Sealing

Violation of calibration law.

Seals may only be broken by authorized, qualified personnel.

### ► Disconnecting the instrument from the power supply

1. Remove the seals.
  2. Open both terminal covers by flipping them up or down respectively.
  3. Remove all connecting cables or leads.
    - Loosen one screw terminal.
    - Pull out the respective connecting cable or lead.
    - Retighten the screw terminal.
    - Repeat this procedure for all other necessary connection cables and/or leads.
    - With TCP/IP Interface: Remove the RJ-45 cable from the RJ-45 socket.
- ↳ The instrument is removed from service.  
If you want to remove it from the installation site, proceed with dismantling ⇨ 58.

## 11.2 DISMANTLING

Required tool: small slotted screwdriver



### **DANGER**

#### **Electric shock due to live components!**

#### **Life endangering due to electric arcs!**

Touching voltage conducting components is life endangering!

The surrounding environment must be free of voltage when the instrument is removed from the installation site.

When disconnecting, observe the five safety rules in accordance with DIN VDE 0105-100, Operation of electrical installations – Part 100: General requirements:

1. Shut down entirely.
2. Secure against restart.
3. Assure absence of voltage at all poles.
4. Ground and short circuit.
5. Cover neighboring live components, or make them inaccessible.

- ✓ The instrument is disconnected from the power supply and all connection cables or leads have been removed from the instrument ⇨ 57.

### ► Removing the Instrument from the Installation Site

1. Pull down the snap connector located on the bottom of the instrument. Push the slotted screwdriver into the slot and pull down to this end.
  2. Tilt the instrument slightly in order to unhook it from the top-hat rail.
    - ↳ Latching is released.
  3. Remove the instrument from the rail.
- ↳ The instrument is removed.  
You can store it for reuse in the future ⇨ 59.  
Alternatively it can be disposed of ⇨ 61.

## 12 TRANSPORT AND STORAGE

If the instrument is (temporarily) removed from service, it can be stored. Please observe the notes in this section in this regard.

The same applies if the instrument is transported, e.g. to a storage location or another place of use.

### ATTENTION

#### Improper Transport

Damage to the product and measuring error

- Transport the instrument only within the limits of permissible ambient conditions (temperature, humidity etc.) ⇨ "Technical Data" 15.
- Use suitable packaging in order to ensure adequate protection against environmental influences and mechanical stress (e.g. impact, damage, contamination etc.).

We recommend transporting the instrument in its original packaging for protection against damage.

### ATTENTION

#### Improper Storage

Damage to the instrument and/or loss of measuring accuracy and compliance with calibration regulations, thus rendering it unusable

- Store the instrument in a protected location and only within the limits of permissible ambient conditions. The respective ambient conditions (temperature, humidity etc.) can be found under ⇨ "Technical Data" 15.
- Use suitable packaging in order to ensure adequate protection against environmental influences and mechanical stress (e.g. damage, contamination etc.).

We recommend storing the instrument in its original packaging for protection against damage.

---

## 13 CONTACT, SUPPORT AND SERVICE

---

Gossen Metrawatt GmbH can be reached directly and simply – we have a single number for everything! Whether you require support or training, or have an individual inquiry, we can answer all of your questions here:

+49-911-8602-0

Monday to Thursday: 8 a.m. to 4 p.m.

Friday: 8 a.m. to 2 p.m.

Or contact us by e-mail at: [info@gossenmetrawatt.com](mailto:info@gossenmetrawatt.com)

Do you prefer support by e-mail?

Measuring and Test Technology: [support@gossenmetrawatt.com](mailto:support@gossenmetrawatt.com)

Industrial Measuring Technology: [support.industrie@gossenmetrawatt.com](mailto:support.industrie@gossenmetrawatt.com)

Enquiries concerning training and seminars can also be submitted by e-mail and online:

[training@gossenmetrawatt.com](mailto:training@gossenmetrawatt.com)

<https://www.gmc-instruments.de/en/knowledge/webinars/>



Please contact GMC-I Service GmbH for repairs, replacement parts and calibration<sup>1</sup>:

+49-911-817718-0

[service@gossenmetrawatt.com](mailto:service@gossenmetrawatt.com)

<https://www.gmci-service.com/en/>

Beuthener Str. 41  
90471 Nürnberg  
Germany



---

1. DAkkS calibration laboratory per DIN EN ISO/IEC 17025  
accredited by the Deutsche Akkreditierungsstelle GmbH under reference number D-K-15080-01-01.

## 14 DISPOSAL AND ENVIRONMENTAL PROTECTION

Proper disposal makes an important contribution to the protection of our environment and the conservation of natural resources.

### ATTENTION

#### Environmental Damage

Improper disposal results in environmental damage.  
Follow the instructions concerning return and disposal included in this section.

The following comments refer specifically to the legal situation in the Federal Republic of Germany. Owners or end users who are subject to other national requirements are required to comply with the respectively applicable national requirements and to implement them correctly on site. Relevant information can be obtained, for example, from the responsible national authorities or national distributors.

#### Waste Electrical Equipment, Electrical or Electronic Accessories and Waste Batteries (including rechargeable batteries)

Electrical equipment and batteries (including rechargeable batteries) contain valuable raw materials that can be recycled, as well as hazardous substances which can cause serious harm to human health and the environment, and they must be recycled and disposed of correctly.



The symbol on the left depicting a crossed-out garbage can on wheels refers to the legal obligation of the owner or end user (German electrical and electronic equipment act ElektroG and German battery act BattG) not to dispose of used electrical equipment and batteries with unsorted municipal waste ("household trash"). Waste batteries must be removed from the old device (where possible) without destroying them and the old device and the waste batteries must be disposed of separately. The battery type and its chemical composition are indicated on the battery's labeling. If the abbreviations "Pb" for lead, "Cd" for cadmium or "Hg" for mercury are included, the battery exceeds the limit for the respective metal.

Please observe the owner's or end user's responsibility with regard to deleting personal data, as well as any other sensitive data, from old devices before disposal.

Old devices, electrical or electronic accessories and waste batteries (including rechargeable batteries) used in Germany can be returned free of charge to Gossen Metrawatt GmbH or the service provider responsible for their disposal in compliance with applicable regulations, in particular laws concerning packaging and hazardous goods. Further information regarding returns can be found on our website.

#### Packaging Materials

We recommend retaining the respective packaging materials for the case that you might require servicing or calibration in the future.



### WARNING

#### Danger of Asphyxiation Resulting from Foils and Other Packaging Materials

Children and other vulnerable persons may suffocate if they wrap themselves in packaging materials, or their components or foils, or if they pull them over their heads or swallow them.

Keep packaging materials, as well as their components and foils, out of the reach of babies, children and other vulnerable persons.

In accordance with German packaging law (VerpackG), the user is obligated to correctly dispose of packaging and its components separately, and not together with unsorted municipal waste ("household trash").

Private end consumers can dispose of packaging free of charge at the responsible collection point. Packaging which is not subject to so-called system participation is returned to the appointed service provider. Further information regarding returns can be found on our website.

---

## 15 CERTIFICATIONS

---

### 15.1 CE DECLARATION

The instrument fulfills all requirements of applicable EU directives and national regulations. We confirm this with the CE mark. This can be found on the Internet at:

<https://www.gmc-instruments.de/en/services/download-center/>



### 15.2 CALIBRATION CERTIFICATE (WITH FEATURE P9 ONLY)

A calibration certificate is included with the instrument.

### 15.3 PROTOTYPE TEST CERTIFICATE

Prototype test certificates can be found on the Internet at:

<https://www.gmc-instruments.de/en/services/download-center/>



### 15.4 NATIONAL DECLARATION OF CONFORMITY

The instrument complies with the German measurement and calibration act and all legal ordinances based on this act. We confirm this by means of the national declaration of conformity. This can be found on the Internet at:

<https://www.gmc-instruments.de/en/services/download-center/>



## B APPENDIX

Abbreviations and their Meanings:

Abbreviation	Meaning
CT	Current transformation ratio
CT × VT	Product of CT times VT
EP <sub>1</sub> ... EP <sub>8</sub> , EP <sub>tot</sub>	Active energy per tariff and total (across all phases)
EQ <sub>1</sub> ... EQ <sub>8</sub> , EQ <sub>tot</sub>	Reactive energy per tariff and total (across all phases)
f	Frequency
I <sub>1</sub> , I <sub>2</sub> , I <sub>3</sub>	Current per phase (TRMS value)
I <sub>N</sub>	Neutral conductor current (calculated)
I <sub>max</sub>	Limit current
I <sub>min</sub>	Minimum current value
I <sub>ref</sub>	Reference current (value)
M0 (feature)	Without multifunctional variant
M1 (feature)	Multifunctional variant: measurement of U, I, P, Q, S, PF, f, THD, I <sub>N</sub>
M2 (feature)	Multifunctional variant: measurement of reactive energy (not approved for billing purposes in Switzerland)
M3 (feature)	Multifunctional variant: measurement of U, I, P, Q, S, PF, f, THD, I <sub>N</sub> , reactive energy (not approved for billing purposes in Switzerland)
P <sub>1</sub> , P <sub>2</sub> , P <sub>3</sub> , P <sub>tot</sub>	Active power, per phase and total
PF <sub>1</sub> , PF <sub>2</sub> , PF <sub>3</sub> , PF <sub>tot</sub>	Power factor (cosφ) per phase and total
P0 (feature)	MID approval
P9 (feature)	MID approval and calibration certificate
Q <sub>1</sub> , Q <sub>2</sub> , Q <sub>3</sub> , Q <sub>tot</sub>	Reactive power, per phase and total
Q1 (feature)	Programmable transformation ratios
Q9 (feature)	Fixed transformation ratios
S <sub>1</sub> , S <sub>2</sub> , S <sub>3</sub> , S <sub>tot</sub>	Apparent power, per phase and total
S0	Pulse rate, S0 output
THD I <sub>1</sub> , I <sub>2</sub> , I <sub>3</sub>	Current distortion component per phase (TRMS value), THD – total harmonic distortion
THD U <sub>1</sub> , U <sub>2</sub> , U <sub>3</sub>	Voltage distortion component per phase (TRMS value), THD – total harmonic distortion
U <sub>n</sub>	Reference voltage
U <sub>1N</sub> , U <sub>2N</sub> , U <sub>3N</sub>	Star voltage (TRMS)
U <sub>12</sub> , U <sub>23</sub> , U <sub>13</sub>	Delta voltage (TRMS)
U3 (feature)	Reference voltage: 100 ... 110 V L–L
U5 (feature)	Reference voltage: 230 V L–N
U6 (feature)	Reference voltage: 400 V L–L
U7 (feature)	Reference voltage: 500 V L–L
V0 (feature)	Without pulse output
V1 (feature)	Pulse output
V2/V4 (feature)	Programmable S0
V9 (feature)	Customer-specific S0 rate
VT	Voltage transformation ratio
W0 (feature)	Pulse output only (without bus connection)
W1 (feature)	LON-Bus
W2 (feature)	M-Bus

---

Abbreviation	Meaning
W4 (feature)	TCP/IP (BACnet, Modbus TCP, HTTP)
W7 (feature)	MODBUS RTU
Z0 (feature)	Without meter reading profile
Z1 (feature)	Meter reading profile (only possible with bus connection)
Z2 (feature)	Certified meter reading profile per PTB-A 50.7 (only in combination with W4, not possible in combination with U3)



**GMC INSTRUMENTS**

 **GOSSEN METRAWATT**

© Gossen Metrawatt GmbH

Prepared in Germany • Subject to change without notice / errors excepted

• A PDF version is available on the Internet

All trademarks, registered trademarks, logos, product names, and company names are the property of their respective owners.

**PLEASE CONTACT:**

**Gossen Metrawatt GmbH**

Südwestpark 15

90449 Nürnberg

Germany



+49 911 8602-0



+49 911 8602-669



info@gossenmetrawatt.com



www.gossenmetrawatt.com